

MINI Series

3.5·7·14·16·21·35MPa



MINI Cylinder

Selection and standard table

Series Name		MR35	MRK35	M70	MR70	MRK70	M140	M210
Bore (mm)	φ15						●	●
	φ20	●	●	●	●	●	●	●
	φ25	●	●	●	●	●	●	●
	φ30	●	●	●	●	●	●	●
Nominal Pressure MPa	3.5	●	●					
	7			●	●	●		
	14						●	
	21							●
Mounting	ST	●	●	●	●	●	●	●
	LB	●	●	●	●	●	●	●
	FA (FB)	●	●	●	●	●	●	●
	CA	●	●	●	●	●	●	●
	TA (TB)	●	Only TA ●	●	●	Only TA ●	●	Only TA ●
Port	E (Side access)	●		●	●		●	●
Double Rod				●			●	
End Joint		●	●	●	●	●	●	●
Cushion Format			●			●	●	
Switch Adjusted		●	●		●	●		
Maximum Stroke		300	300	300	300	300	300	300
Feature		Round shape	Round shape	Round shape	Round shape	Round shape	Round shape	Round shape

Note) In the case of M140 and M210, when the stroke is 25mm or less, it applies to the dimension of the stroke 25mm.

MINI Series

MR35 Series ■ 3.5MPa



Specifications

Series Name	MR35		
Bore	φ20·φ25·φ30		
Nominal Pressure	3.5MPa		
Proof Pressure	5.3MPa		
Minimum Working Pressure	0.3MPa		
Range of Operating Speed	10 to 300mm/s		
Range of Operating Temperature	-10°C to +60°C		
Hydraulic Oil Applied	General purpose mineral hydraulic oil		
Thread Tolerance	JIS6g/6H		
Stroke Tolerance (Grade A) Units:mm	100 and below	101 to 250	251 to 300
	+0.8 0	+1.0 0	+1.25 0

Note) The phosphoric acid ester cannot be used for the hydraulic fluid.

Standard Stroke

		Units:mm						
Stroke		25	50	75	100	150	200	Maximum
Bore	φ20	○	○	○	○	○	○	300
	φ25	○	○	○	○	○	○	300
	φ30	○	○	○	○	○	○	300

Note) Able to produce any stroke by maximum stroke.

Switch Specifications

Type	10
Rated Voltage	AC/DC5 to 100V
Rated Current	5 to 50mA (Indicator Lamp is red 3 to 50mA)
Maximum Contact Capacity	AC/DC 10VA
Closed Circuit Voltage Drops	2.5V or less
Impact Resistance	30G
Lead Length	Side access
	Standard length : 1 m (Special order : 5 m)
Indicator Lamp	LED lights at all aspects ON.
Leak Current at OFF	0
Contact Dielectric Strength	200 VDC for one minute, Leak current: 1 mA or less
Protective construction	IP67

Note 1) To select a switch, check the current rating of the small relay coil, and the input current of PLC (programmable controller), and use the switch within the above operating current range.

Note 2) "Type 10" provides IP68 enclosure rating. It shall be tested depending on submersion depth.

Note 3) Red and green switches are available. There is no difference in performance.

Minimum stroke that can install switch

In case of one switch : 10mm
In case of two switches : 25mm

Code

MR35 - 1 LB 25×25 E - SB 101 - T - J

① ② ③ ④ ⑤ ⑥ ⑦ ⑧ ⑨ ⑩

① Series Name	MR35					
② Packing Material	1:Nitrile Rubber					
③ Mounting	Basic (ST)	Axis Direction Foot (LB)	Head Side: Flange (FA)	Single Protrusion Clevis (CA)	Head Side Trunnion (TA)	Cap Side Trunnion (TB)
④ Bore (mm)	20·25·30					
⑤ Stroke Length (mm)	Indicate the stroke. (1-mm step, until 300 mm)					
⑥ Port Location ^{Note)}	No notation : Standard E: Cap-side port, side access (ST, FA and TA only)					
⑦ Switch Quantity	SO: No switch SR: Head-side switch (1 piece) SH: Cap-side switch (1 piece) SB: Two switches SC: Three switches					
⑧ Switch Type	101:10 type, 1m cord (Standard) 105:10 type, 5m cord (Standard Equivalent)					
⑨ End Joint	T:Single Protrusion End Joint Y:Double Protrusion End Joint					
⑩ Bellows	No notation : None J:With Bellows					

Note) Please refer to the dimensional outline drawing for the port position.

MINI Series

MR35 Series ■ 3.5MPa

Basic Type [ST]

With Mounting Nut

Mounting nut (Shaded area)

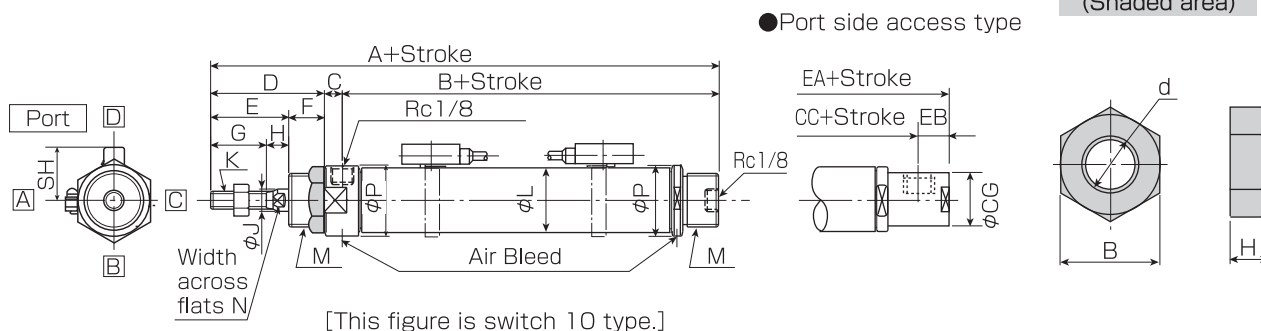

Units:mm

Symbol Bore	A	B	C	D	E	F	G	H	φJ	K	L	M	N	P	Port side access type				Switch
															EA	EB	CC	φCG	SH
φ20	150	91	8	51	35	16	25	10	10	M8 P1.0	26	M24 P1.5	8	29	155	11	85	18	22
φ25	150	91	8	51	35	16	25	10	12	M10 P1.25	31	M24 P1.5	10	34	155	11	85	22	24.5
φ30	160	94	8	58	40	18	30	10	14	M12 P1.25	36	M26 P1.5	12	39	166	12	88	26	27

Units:mm

Symbol Bore	d	H	B
φ20	M24 P1.5	8	30
φ25	M24 P1.5	8	30
φ30	M26 P1.5	8	32

With Bellows (Material: Nylon tarporin, Heat resistance: 80°C)

Example 1: Foot (LB)

Example 2: Trunnion (TA)

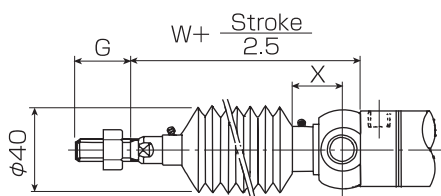
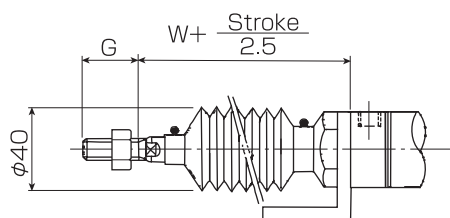

Units:mm

Symbol Bore	W	G	X
φ20	55	25	23
φ25	55	25	23
φ30	59	30	25

Note) For a cylinder with 37.5 mm or shorter stroke (with dust cover), calculate "W + 15".

End Joint

Lock Nut

Single Protrusion End Joint : T type

Double Protrusion End Joint: Y type
: Pin, Washer, Split pin

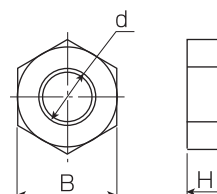
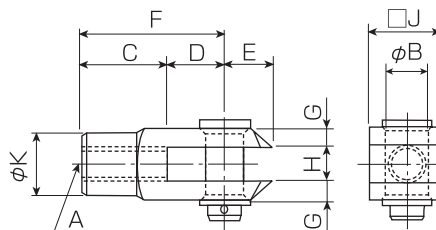
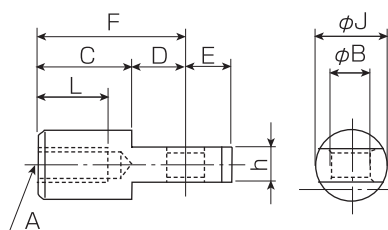

Units:mm

Symbol Bore	A	B bore dia	B shaft dia	C		D		E		F	G	H	h	□J/ φJ	φK	L
				Y joint	T joint	Y joint	T joint	Y joint	T joint							
φ20	M8 P1.0	8 ^{+0.022} ₀	8 ^{-0.013} _{-0.035}	16	20	16	12	10	10	32	4	8 ^{+0.1} ₀	8 ⁰ _{-0.1}	16	14	14
φ25	M10 P1.25	10 ^{+0.022} ₀	10 ^{-0.013} _{-0.035}	20	25	20	15	12	12	40	5	10 ^{+0.1} ₀	10 ⁰ _{-0.1}	20	18	17.5
φ30	M12 P1.25	12 ^{+0.027} ₀	12 ^{-0.016} _{-0.043}	24	30	24	18	14	14	48	6	12 ^{+0.2} ₀	12 ⁰ _{-0.2}	24	20	21

Units:mm

Symbol Bore	d	H	B
φ20	M8 P1.0	6.5	13
φ25	M10 P1.25	8	17
φ30	M12 P1.25	10	19

Axis Direction Foot (LB)

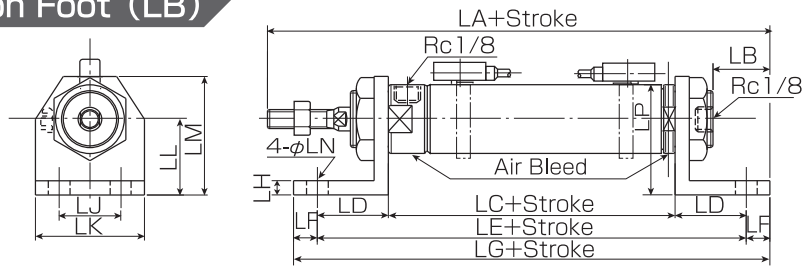

Units:mm

Symbol	LA	LB	LC	LD	LE	LF	LG	LH	φLN	LP	LJ	LK	LL	LM
φ20	174	24	83	30	143	10	163	6	9	46.5	26	46	32	50
φ25	174	24	83	30	143	10	163	6	9	49.0	26	46	32	50
φ30	184	24	86	30	146	10	166	6	9	51.5	26	46	32	50

Note) Please refer to the ST type for other dimensions.

Head Side Flange (FA)

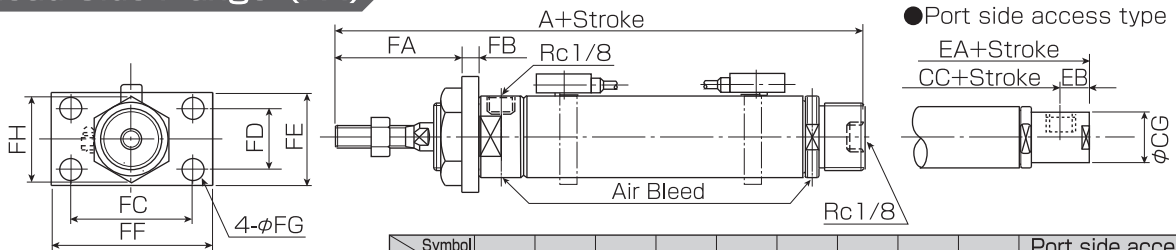

Units:mm

Symbol	A	FA	FB	FC	FF	FD	FE	φFG	FH	Port side access type			
										EA	EB	CC	φCG
φ20	150	45	6	50	66	25	38	9	35	155	11	85	18
φ25	150	45	6	50	66	25	38	9	35	155	11	85	22
φ30	160	49	9	55	71	25	38	9	38	166	12	88	26

Note) Please refer to the ST type for other dimensions.

Single Protrusion Clevis (CA) <Port side access type only>

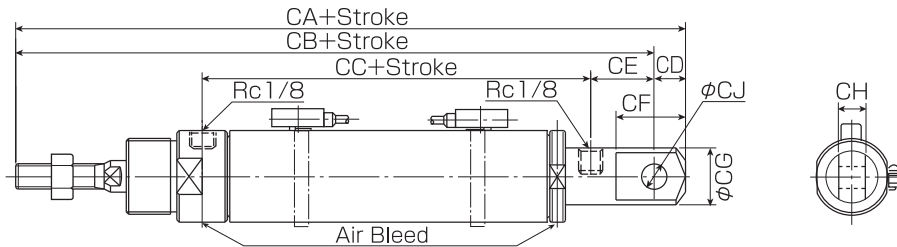

Units:mm

Symbol	CA	CB	CC	CE	CD	CF	φCG	φCJ	CH
φ20	174	164	85	20	10	22	18	8 ^{+0.02} ₀	10 ⁰ _{-0.2}
φ25	182	169	85	25	13	30	22	10 ^{+0.02} ₀	12 ⁰ _{-0.2}
φ30	196	181	88	27	15	33	26	12 ^{+0.02} ₀	14 ⁰ _{-0.2}

Note) Please refer to the ST type for other dimensions.

Head Side Trunnion (TA)

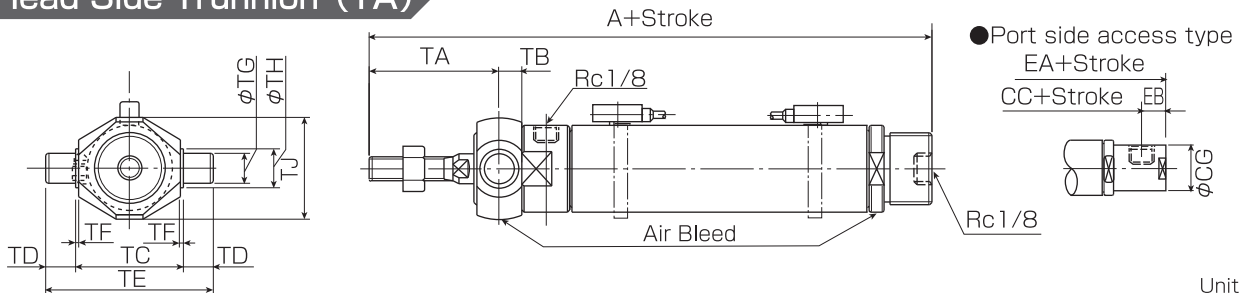

Units:mm

Symbol	A	TA	TB	TC	TD	φTE	TF	φTG	φTH	TJ	Port side access type			
											EA	EB	CC	φCG
φ20	150	43.5 ⁰ _{-0.8}	7.5 ^{+0.8} ₀	36±0.1	10	56±0.2	1	10 ⁰ _{-0.02}	13	34	155	11	85	18
φ25	150	43.5 ⁰ _{-0.8}	7.5 ^{+0.8} ₀	36±0.1	10	56±0.2	1	10 ⁰ _{-0.02}	13	34	155	11	85	22
φ30	160	50.0 ⁰ _{-0.8}	8.0 ^{+0.8} ₀	42±0.1	12	66±0.2	1	12 ⁰ _{-0.02}	14	39	166	12	88	26

Note) Please refer to the ST type for other dimensions.

MINI Series

MRK35 Series ■ 3.5MPa

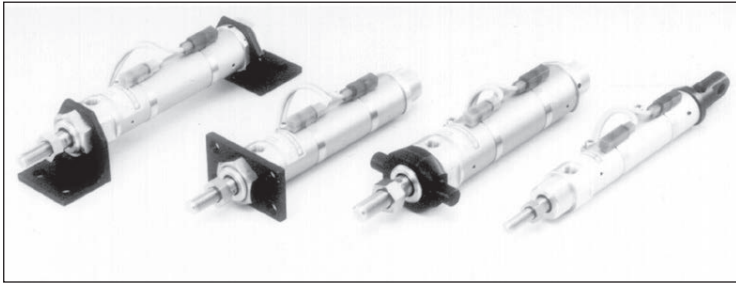

► Specifications

Series Name	MR35		
Bore	φ20·φ25·φ30		
Nominal Pressure	3.5MPa		
Proof Pressure	5.3MPa		
Minimum Working Pressure	0.3MPa		
Range of Operating Speed	10 to 300mm/s		
Range of Operating Temperature	-10°C to +60°C		
Hydraulic Oil Applied	General purpose mineral hydraulic oil		
Thread Tolerance	JIS6g/6H		
Stroke Tolerance (Grade A) Units:mm	100 and below	101 to 250	251 to 300
	+0.8 0	+1.0 0	+1.25 0

Note) The phosphoric acid ester cannot be used for the hydraulic fluid.

► Standard Stroke

Stroke	Units:mm						
	25	50	75	100	150	200	Maximum
Bore	φ20	○	○	○	○	○	300
	φ25	○	○	○	○	○	300
	φ30	○	○	○	○	○	300

Note) Able to produce any stroke by maximum stroke.

► Switch Specifications

Type	10
Rated Voltage	AC/DC5 to 100V
Rated Current	5 to 50mA (Indicator Lamp is red 3 to 50mA)
Maximum Contact Capacity	AC/DC 10VA
Closed Circuit Voltage Drops	2.5V or less
Impact Resistance	30G
Lead Length	Side access
	Standard length : 1 m (Special order : 5 m)
Indicator Lamp	LED lights at all aspects ON.
Leak Current at OFF	0
Contact Dielectric Strength	200 VDC for one minute, Leak current: 1 mA or less
Protective construction	IP67

Note 1) To select a switch, check the current rating of the small relay coil, and the input current of PLC (programmable controller), and use the switch within the above operating current range.

Note 2) "Type 10" provides IP68 enclosure rating. It shall be tested depending on submersion depth.

Note 3) Red and green switches are available. There is no difference in performance.

Minimum stroke that can install switch

▶ In case of one switch : 10mm
In case of two switches : 25mm

■ Code

MRK35 - 1 LB 25×25 B A - SB 101 - T

① ② ③ ④ ⑤ ⑥ ⑦ ⑧ ⑨ ⑩

① Series Name	MRK35				
② Packing Material	1:Nitrile Rubber				
③ Mounting	Basic (ST)	Axis Direction Foot (LB)	Head Side: Flange (FA)	Single Protrusion Clevis (CA)	Head Side Trunnion (TA)
④ Bore (mm)	20·25·30				
⑤ Stroke Length (mm)	Indicate the stroke. (1-mm step, until 300 mm)				
⑥ Cushion Format	R:Cushion on Head side H:Cushion on Cap side B:Cushion on both sides (Standard) N:None				
⑦ Cushion valve location <small>Note)</small>	No notation : Standard (C position) A:A position B:B position				
⑧ Switch Quantity	SO: No switch		SR: Head-side switch (1 piece)	SH: Cap-side switch (1 piece)	
	SB: Two switches		SC: Three switches		
⑨ Switch Type	101:10 type, 1m cord (Standard)		105:10 type, 5m cord (Standard Equivalent)		
⑩ End Joint	T:Single Protrusion End Joint Y:Double Protrusion End Joint				

Note) The standard cushion valve position is shown in the outer dimension drawing. If the cushion valve position is different from the standard position, specify the "A", "B" or "C" symbol shown in the figure.

Basic Type [ST]

■ With Mounting Nut

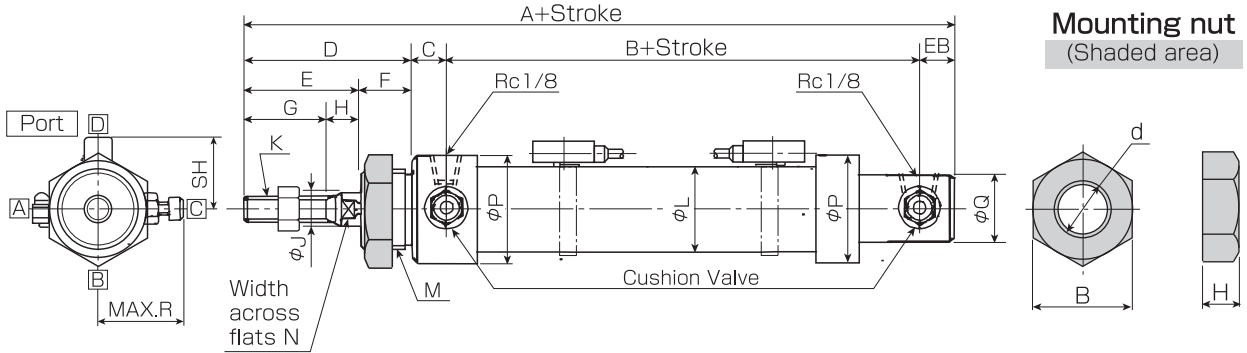

[This figure is switch 10 type.]

Units:mm

Symbol	A	B	C	D	E	F	G	H	J	K	L	M	N	P	Q	R	EB	SH
φ20	172	102	8	51	35	16	25	10	10	M8 P1.0	26	M24 P1.5	8	29	22	26.5	11	22
φ25	173	103	8	51	35	16	25	10	12	M10 P1.25	31	M24 P1.5	10	34	24	29	11	24.5
φ30	184	107	8	58	40	18	30	10	14	M12 P1.25	36	M26 P1.5	12	39	26	33	11	27

Units:mm

Symbol	d	H	B
φ20	M24 P1.5	8	30
φ25	M24 P1.5	8	30
φ30	M26 P1.5	8	32

■ End Joint

Lock Nut

Single Protrusion End Joint : T type

Double Protrusion End Joint: Y type
: Pin, Washer, Split pin

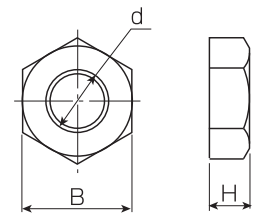
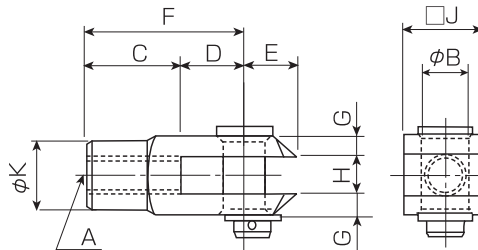
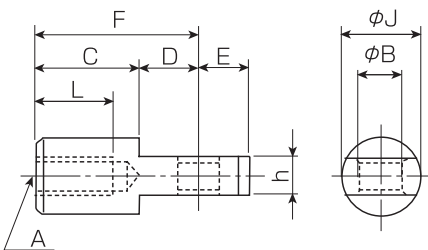

Units:mm

Symbol	A	B bore dia	B shaft dia	C		D		E		F	G	H	h	□J/ φJ	φK	L
				Y joint	T joint	Y joint	T joint	Y joint	T joint							
φ20	M8 P1.0	8 ^{+0.022} ₀	8 ^{-0.013} _{-0.035}	16	20	16	12	10	10	32	4	8 ^{+0.1} ₀	8 ^{-0.1} ₀	16	14	14
φ25	M10 P1.25	10 ^{+0.022} ₀	10 ^{-0.013} _{-0.035}	20	25	20	15	12	12	40	5	10 ^{+0.1} ₀	10 ^{-0.1} ₀	20	18	17.5
φ30	M12 P1.25	12 ^{+0.027} ₀	12 ^{-0.016} _{-0.043}	24	30	24	18	14	14	48	6	12 ^{+0.2} ₀	12 ^{-0.2} ₀	24	20	21

Units:mm

Symbol	d	H	B
φ20	M8 P1.0	6.5	13
φ25	M10 P1.25	8	17
φ30	M12 P1.25	10	19

MINI Series

MRK35 Series ■ 3.5MPa

Axis Direction Foot (LB)

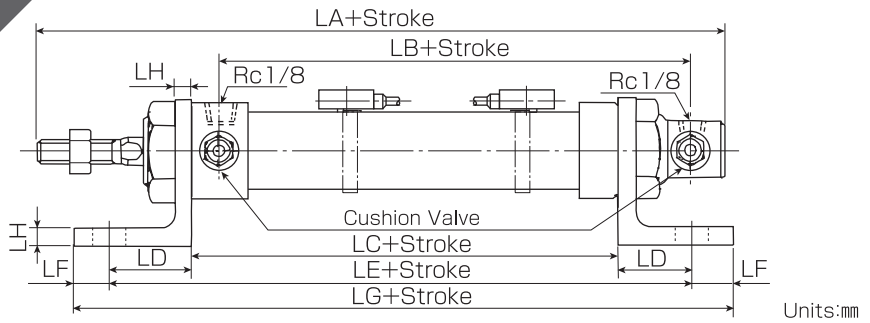
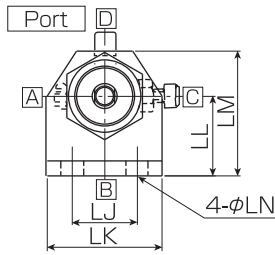

Symbol	LA	LB	LC	LD	LE	LF	LG	LH	LJ	LK	LL	LM	φLN
φ20	183	113	92	30	152	10	172	5.5	26	46	32	50	9
φ25	181	111	93	30	153	10	173	5.5	26	46	32	50	9
φ30	194	117	96	30	156	10	176	5.5	26	46	32	50	9

Note) Please refer to the ST type for other dimensions.

Head Side Flange (FA)

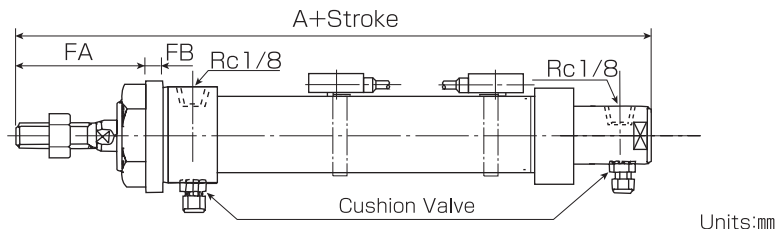
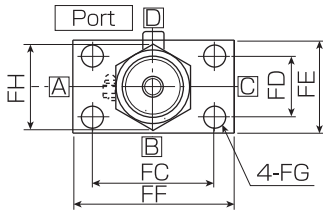

Symbol	A	FA	FB	FC	FD	FE	FF	φFG	FH
φ20	172	45	6	50	25	38	66	9	35
φ25	173	45	6	50	25	38	66	9	35
φ30	184	49	9	55	25	38	71	9	38

Note) Please refer to the ST type for other dimensions.

Single Protrusion Clevis (CA)

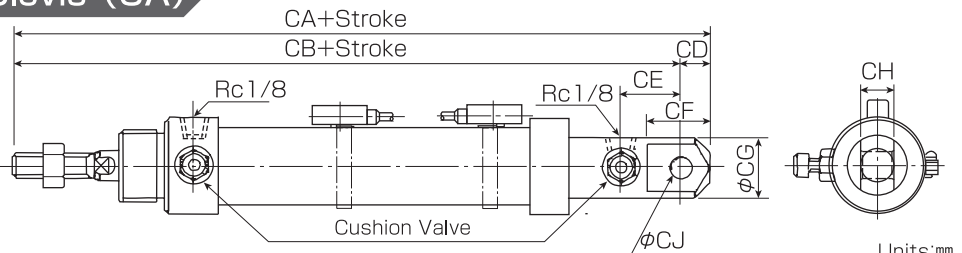
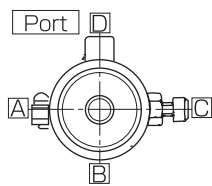

Symbol	CA	CB	CD	CE	CF	φCG	CH	φCJ
φ20	193	183	10	22	22	22	10 ⁰ _{-0.2}	8 ^{+0.02} ₀
φ25	202	189	13	27	30	24	12 ⁰ _{-0.2}	10 ^{+0.02} ₀
φ30	215	200	15	27	33	26	14 ⁰ _{-0.2}	12 ^{+0.02} ₀

Note) Please refer to the ST type for other dimensions.

Head Side Trunnion (TA)

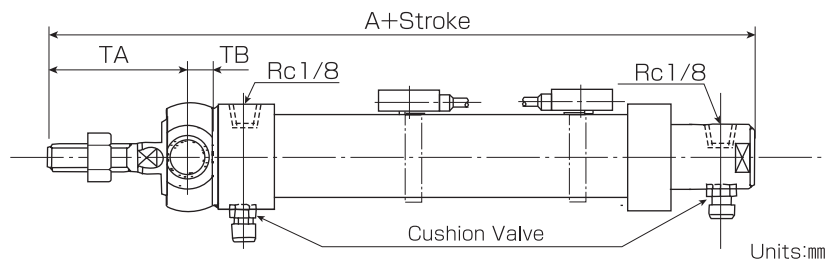
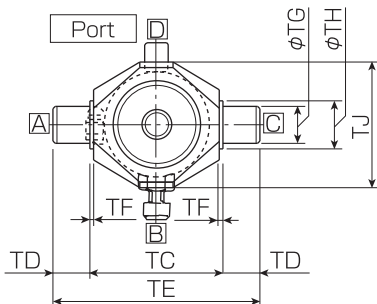

Symbol	A	TA	TB	TC	TD	TE	TF	φTG	φTH	TJ
φ20	172	43.5	7.5	36	10	56	1	10 ⁰ _{-0.02}	13	34
φ25	173	43.5	7.5	36	10	56	1	10 ⁰ _{-0.02}	13	34
φ30	184	50	8	42	12	66	1	12 ⁰ _{-0.02}	14	39

Note) Please refer to the ST type for other dimensions.

MINI Series

M70 Series ■ 7MPa

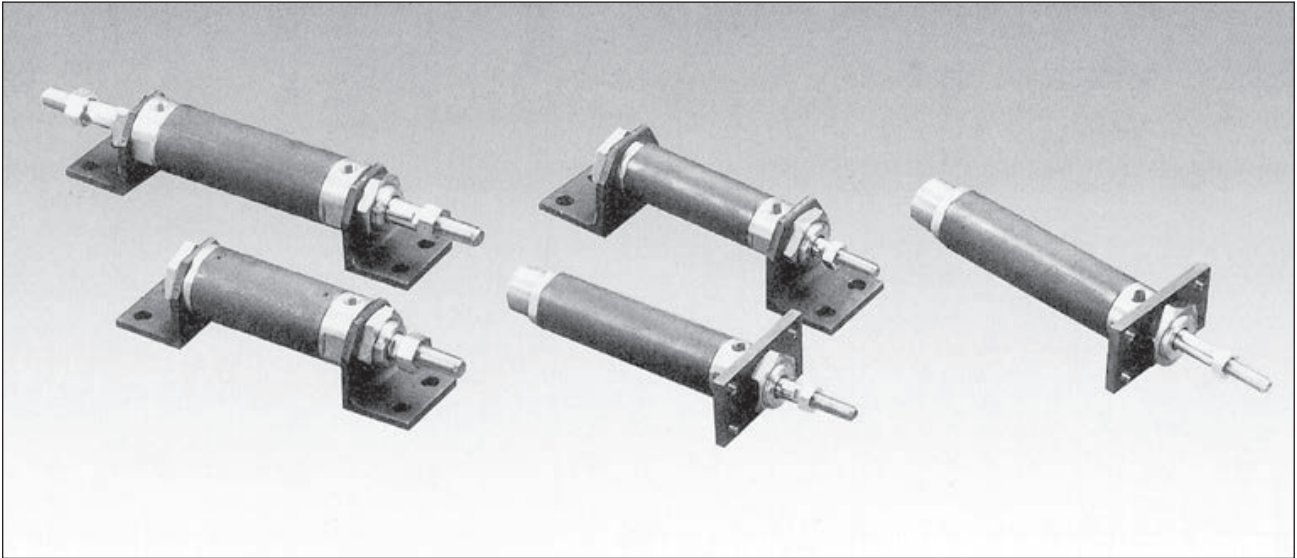

Specifications

Series Name	Single rod type:M70S	Double rod type:M70D	
Bore	φ20·φ25·φ30		
Nominal Pressure	7MPa		
Proof Pressure	10.5MPa		
Minimum Working Pressure	0.3MPa or less		
Range of Operating Speed	10 to 300mm/s		
Range of Operating Temperature	-10°C to +80°C		
Cushion Format <small>Note)</small>	None		
Hydraulic Oil Applied	General purpose mineral hydraulic oil		
Thread Tolerance	JIS6g/6H		
Stroke Tolerance (Grade A) Units:mm	100 and below	101 to 250	251 to 300
	+0.8 0	+1.0 0	+1.25 0

Standard Stroke

		Units:mm						
Stroke		25	50	75	100	150	200	Maximum
Bore	φ20	○	○	○	○	○	○	300
	φ25	○	○	○	○	○	○	300
	φ30	○	○	○	○	○	○	300

Note) Able to produce any stroke by maximum stroke.

Note) Please refer to the <Attention when using it> on P.179 for the application hydraulic fluid.

Code

M70S - 1 LB 25×25 E - T - J

① ② ③ ④ ⑤ ⑥ ⑦ ⑧

① Series Name	M70S:Single rod type M70D:Double rod type					
② Packing Material	1:Nitrile Rubber					
③ Mounting	Basic (ST)	Axis Direction Foot (LB)	Head Side: Flange (FA)	Single Protrusion Clevis (CA)	Head Side Trunnion (TA)	Cap Side Trunnion (TB)
④ Bore (mm)	20·25·30					
⑤ Stroke Length (mm)	Indicate the stroke. (1-mm step, until 300 mm)					
⑥ Port Location <small>Note)</small>	No notation:None E: Cap-side port side access (ST, FA and TA only) The double rod type provides Cap-side port side access type only. (No specific code is required.)					
⑦ End Joint	T:Single Protrusion End Joint Y:Double Protrusion End Joint					
⑧ Bellows	No notation : None J:With Bellows					

Note) Please refer to the dimensional outline drawing for the port position.

MINI Series

M70 Series ■ 7MPa

Basic Type [ST]

■ With Mounting Nut

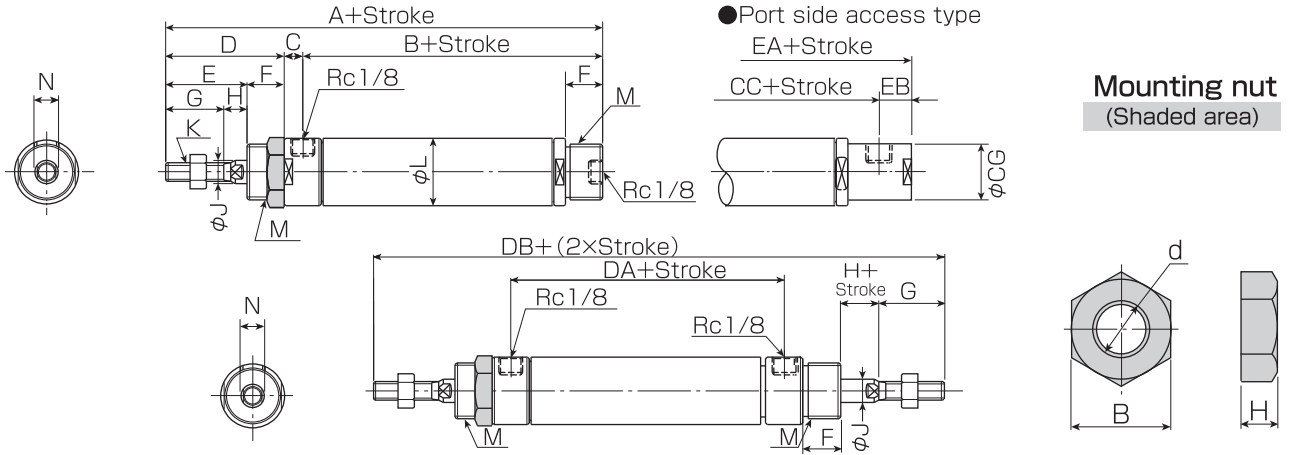

Units:mm

Symbol Bore	A	B	C	D	E	F	G	H	φJ	K	L	M	N	Port side access type				Double Rod type	
	EA	EB	CC	φCG	DA	DB													
φ20	138	79	8	51	35	16	25	10	10	M8 P1.0	29	M24 P1.5	8	143	11	73	18	91	209
φ25	138	79	8	51	35	16	25	10	12	M10 P1.25	34	M24 P1.5	10	143	11	73	22	91	209
φ30	148	82	8	58	40	18	30	10	14	M12 P1.25	39	M26 P1.5	12	154	12	76	26	94	226

Units:mm

Symbol Bore	d	H	B
φ20	M24 P1.5	8	30
φ25	M24 P1.5	8	30
φ30	M26 P1.5	8	32

■ With Bellows (Material: Nylon tarporin, Heat resistance: 80°C)

Example 1: Foot (LB)

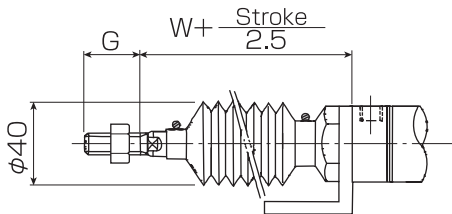

Example 2 : Trunnion (TA)

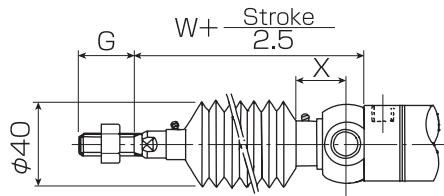

Units:mm

Symbol Bore	W	G	X
φ20	55	25	23
φ25	55	25	23
φ30	59	30	24

Note) For a cylinder with 37.5 mm or shorter stroke (with dust cover), calculate "W + 15".

■ End Joint

Single Protrusion End Joint : T type

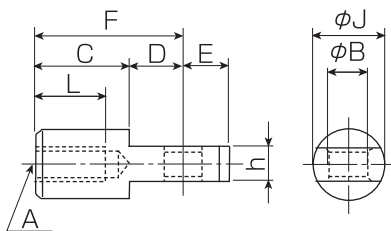

Double Protrusion End Joint: Y type
: Pin, Washer, Split pin

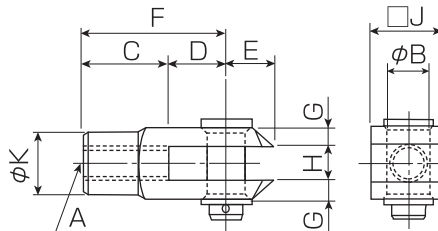

Lock Nut

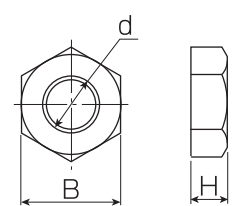

Units:mm

Symbol Bore	A	B bore dia	B shaft dia	C		D		E		F	G	H	h	φJ/φJ	φK	L
				Y joint	T joint	Y joint	T joint	Y joint	T joint							
φ20	M8 P1.0	8 ^{+0.022} ₀	8 ^{-0.013} _{-0.035}	16	20	16	12	10	10	32	4	8 ^{+0.1} ₀	8 ⁰ _{-0.1}	16	14	14.0
φ25	M10 P1.25	10 ^{+0.022} ₀	10 ^{-0.013} _{-0.035}	20	25	20	15	12	12	40	5	10 ^{+0.1} ₀	10 ⁰ _{-0.1}	20	18	17.5
φ30	M12 P1.25	12 ^{+0.027} ₀	12 ^{-0.016} _{-0.043}	24	30	24	18	14	14	48	6	12 ^{+0.2} ₀	12 ⁰ _{-0.2}	24	20	21.0

Units:mm

Symbol Bore	d	H	B
φ20	M8 P1.0	6.5	13
φ25	M10 P1.25	8	17
φ30	M12 P1.25	10	19

Axis Direction Foot (LB)

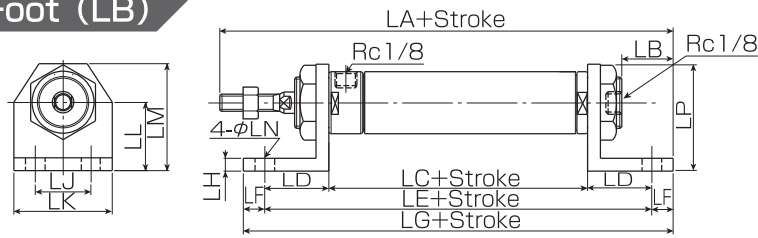

Units:mm

Symbol	LA	LB	LC	LD	LE	LF	LG	LH	LJ	LK	LL	LM	φLN	LP
φ20	162	24	71	30	131	10	151	6	26	46	32	50	9	46.5
φ25	162	24	71	30	131	10	151	6	26	46	32	50	9	49.0
φ30	172	24	74	30	134	10	154	6	26	46	32	50	9	51.5

Note) Please refer to the ST type for other dimensions.

Head Side Flange (FA)

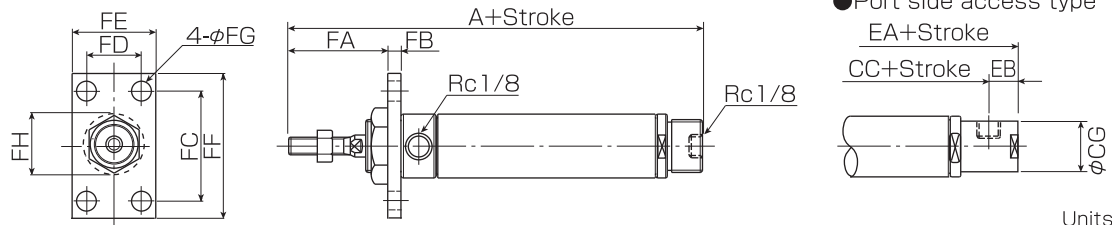

Units:mm

Symbol	A	FA	FB	FC	FD	FE	FF	φFG	FH	Port side access type			
										EA	EB	CC	CG
φ20	138	45	6	50	25	38	66	9	35	143	11	73	18
φ25	138	45	6	50	25	38	66	9	35	143	11	73	22
φ30	148	49	9	55	25	38	71	9	38	154	12	76	26

Note) Please refer to the ST type for other dimensions.

Single Protrusion Clevis (CA) <Port side access type only>

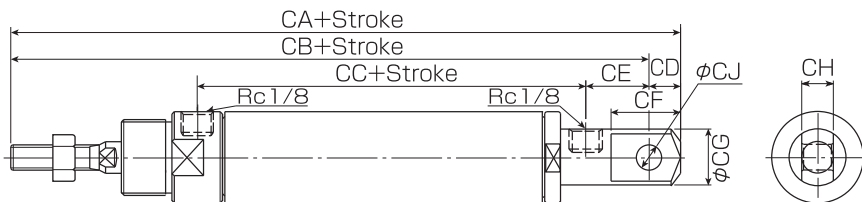

Units:mm

Symbol	CA	CB	CC	CD	CE	CF	φCG	CH	φCJ
φ20	162	152	73	10	20	22	18	10 ^{-0.2} ₀	8 ^{+0.02} ₀
φ25	170	157	73	13	25	30	22	12 ^{-0.2} ₀	10 ^{+0.02} ₀
φ30	184	169	76	15	27	33	26	14 ^{-0.2} ₀	12 ^{+0.02} ₀

Note) Please refer to the ST type for other dimensions.

Head Side Trunnion (TA)

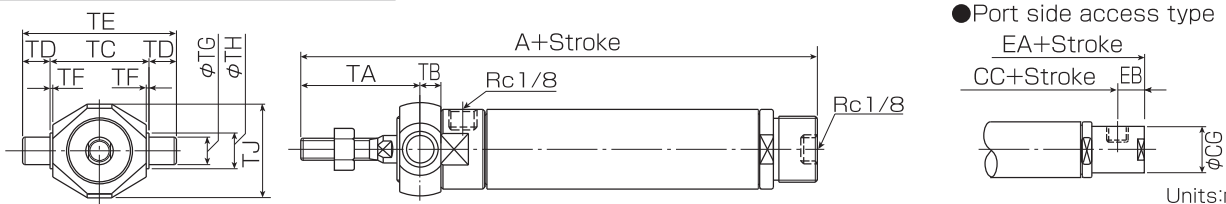

Units:mm

Symbol	A	TA	TB	TC	TD	TE	TF	φTG	φTH	TJ	Port side access type			
											EA	EB	CC	φCG
φ20	138	43.5 ⁰ _{-0.8}	7.5 ^{+0.8} ₀	36±0.1	10	56±0.2	1	10 ⁰ _{-0.02}	13	34	143	11	73	18
φ25	138	43.5 ⁰ _{-0.8}	7.5 ^{+0.8} ₀	36±0.1	10	56±0.2	1	10 ⁰ _{-0.02}	13	34	143	11	73	22
φ30	148	50.0 ⁰ _{-0.8}	8.0 ^{+0.8} ₀	42±0.1	12	66±0.2	1	12 ⁰ _{-0.02}	14	39	154	12	76	26

Note) Please refer to the ST type for other dimensions.

MINI Series

MR70 Series ■ 7MPa



Specifications

Series Name	MR70		
Bore	φ20·φ25·φ30		
Nominal Pressure	7MPa		
Proof Pressure	10.5MPa		
Minimum Working Pressure	0.3MPa or less		
Range of Operating Speed	10 to 300mm/s		
Range of Operating Temperature	-10°C to +80°C		
Cushion Format	None		
Hydraulic Oil Applied	General purpose mineral hydraulic oil		
Thread Tolerance	JIS6g/6H		
Stroke Tolerance (Grade A) Units:mm	100 and below	101 to 250	251 to 300
	+0.8 0	+1.0 0	+1.25 0

Note) Please refer to the <Attention when using it> on P.179 for the application hydraulic fluid.

Standard stroke

Stroke	Units:mm						
	25	50	75	100	150	200	Maximum
Bore	φ20	○	○	○	○	○	300
	φ25	○	○	○	○	○	300
	φ30	○	○	○	○	○	300

Note) Able to produce any stroke by maximum stroke.

Switch Specifications

Type	10
Rated Voltage	AC/DC5 to 100V
Rated Current	5 to 50mA (Indicator Lamp is red 3 to 50mA)
Maximum Contact Capacity	AC/DC 10VA
Closed Circuit Voltage Drops	2.5V or less
Impact Resistance	30G
Lead Length	Side access
	Standard length : 1 m (Special order : 5 m)
Indicator Lamp	LED lights at all aspects ON.
Leak Current at OFF	0
Contact Dielectric Strength	200 VDC for one minute, Leak current: 1 mA or less
Protective construction	IP67

Note 1) To select a switch, check the current rating of the small relay coil, and the input current of PLC (programmable controller), and use the switch within the above operating current range.

Note 2) "Type 10" provides IP68 enclosure rating. It shall be tested depending on submersion depth.

Note 3) Red and green switches are available. There is no difference in performance.

Minimum stroke that can install switch

▶ In case of one switch : 10mm
▶ In case of two switches : 25mm

Code

MR70 - 1 LB 25×25 E - SB 101 - T - J

① ② ③ ④ ⑤ ⑥ ⑦ ⑧ ⑨ ⑩

① Series Name	MR70					
② Packing Material	1:Nitrile Rubber					
③ Mounting	Basic (ST)	Axis Direction Foot (LB)	Head Side: Flange (FA)	Single Protrusion Clevis (CA)	Head Side Trunnion (TA)	Cap Side Trunnion (TB)
④ Bore (mm)	20·25·30					
⑤ Stroke Length (mm)	Indicate the stroke. (1-mm step, until 300 mm)					
⑥ Port Location ^{Note)}	No notation : Standard E: Cap-side port, side access (ST, FA and TA only)					
⑦ Switch Quantity	SO: No switch (Body only) SR: Head-side switch (1 piece) SH: Cap-side switch (1 piece) SB: Two switches SC: Three switches					
⑧ Switch Type	101:10 type, 1m cord (Standard) 105:10 type, 5m cord (Standard Equivalent)					
⑨ End Joint	T:Single Protrusion End Joint Y:Double Protrusion End Joint					
⑩ Bellows	No notation : None J:With Bellows					

Note) Please refer to the dimensional outline drawing for the port position.

Basic Type [ST]

With Mounting Nut

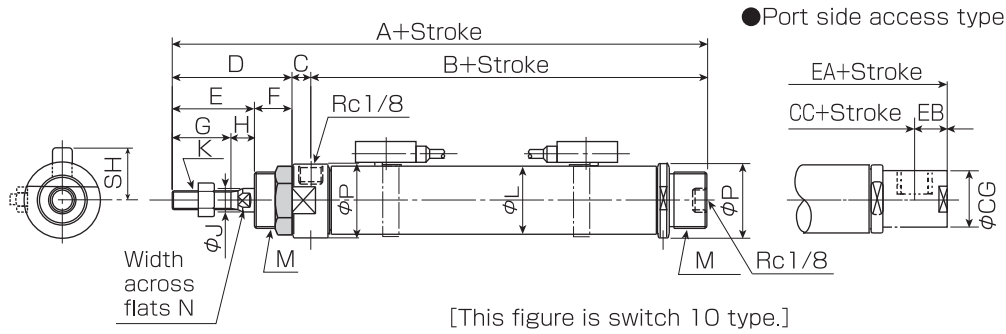

Mounting nut
(Shaded area)

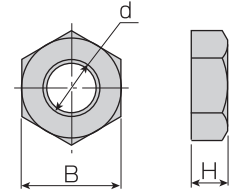

Symbol Bore	Units:mm														Switch SH	Port side access type			
	A	B	C	D	E	F	G	H	J	K	L	M	N	P		EA	EB	CC	ϕCG
ϕ20	150	91	8	51	35	16	25	10	10	M8 P1.0	26	M24 P1.5	8	29	22	155	11	85	18
ϕ25	150	91	8	51	35	16	25	10	12	M10 P1.25	31	M24 P1.5	10	34	24.5	155	11	85	22
ϕ30	160	94	8	58	40	18	30	10	14	M12 P1.25	36	M26 P1.5	12	39	27	166	12	88	26

Symbol Bore	Units:mm		
	d	H	B
ϕ20	M24 P1.5	8	30
ϕ25	M24 P1.5	8	30
ϕ30	M26 P1.5	8	32

With Bellows (Material: Nylon tarporin, Heat resistance: 80°C)

Example 1: Foot (LB)

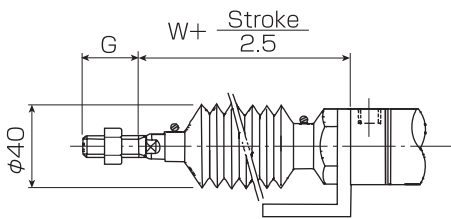

Example 2: Trunnion (TA)

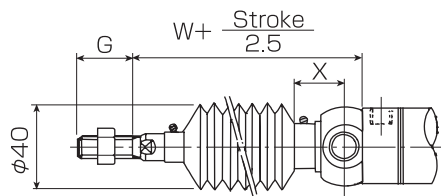

Symbol Bore	Units:mm		
	W	G	X
ϕ20	55	25	23
ϕ25	55	25	23
ϕ30	59	30	24

Note) For a cylinder with 37.5 mm or shorter stroke (with dust cover), calculate "W + 15".

End Joint

Single Protrusion End Joint : T type

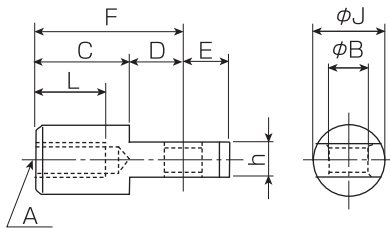

Double Protrusion End Joint: Y type
: Pin, Washer, Split pin

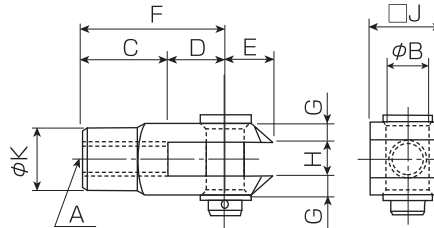

Lock Nut

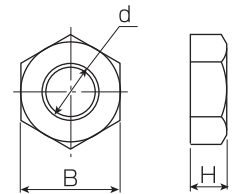

Symbol Bore	Units:mm																	
	A	B bore dia	B shaft dia	C				D		E		F	G	H	h	ϕJ/ϕJ	ϕK	L
				Y joint	T joint	Y joint	T joint	Y joint	T joint									
ϕ20	M8 P1.0	8 ^{+0.022} ₀	8 ^{-0.013} _{-0.035}	16	20	16	12	10	10	32	4	8 ^{+0.1} ₀	8 ⁻⁰ _{-0.1}	16	14	14.0		
ϕ25	M10 P1.25	10 ^{+0.022} ₀	10 ^{-0.013} _{-0.035}	20	25	20	15	12	12	40	5	10 ^{+0.1} ₀	10 ⁻⁰ _{-0.1}	20	18	17.5		
ϕ30	M12 P1.25	12 ^{+0.027} ₀	12 ^{-0.016} _{-0.043}	24	30	24	18	14	14	48	6	12 ^{+0.2} ₀	12 ⁻⁰ _{-0.2}	24	20	21.0		

Symbol Bore	Units:mm		
	d	H	B
ϕ20	M8 P1.0	6.5	13
ϕ25	M10 P1.25	8	17
ϕ30	M12 P1.25	10	19

MINI Series

MR70 Series ■ 7MPa

Axis Direction Foot (LB)

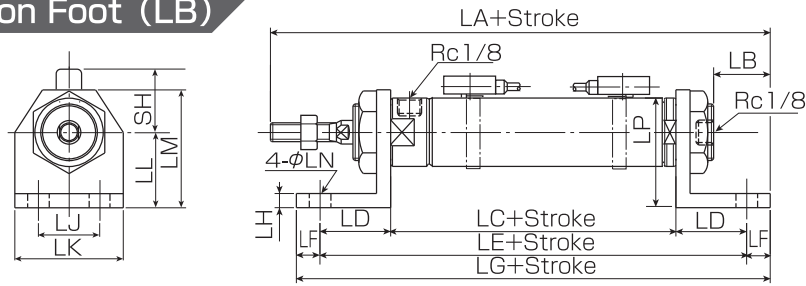

Units:mm

Symbol	LA	LB	LC	LD	LE	LF	LG	LH	LJ	LK	LL	LM	φLN	LP	Switch SH
φ20	174	24	83	30	143	10	163	6	26	46	32	50	9	46.5	22
φ25	174	24	83	30	143	10	163	6	26	46	32	50	9	49.0	24.5
φ30	184	24	86	30	146	10	166	6	26	46	32	50	9	51.5	27

Note) Please refer to the ST type for other dimensions.

Head Side Flange (FA)

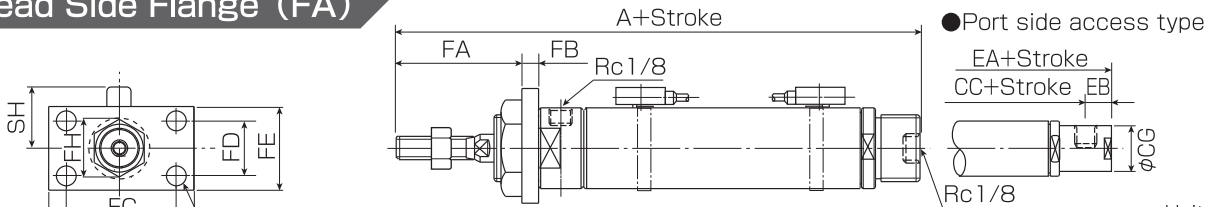

Units:mm

Symbol	A	FA	FB	FC	FD	FE	FF	φFG	FH	Switch SH	Port side access type			
Bore											EA	EB	CC	φCG
φ20	150	45	6	50	25	38	66	9	35	22	155	11	85	18
φ25	150	45	6	50	25	38	66	9	35	24.5	155	11	85	22
φ30	160	49	9	55	25	38	71	9	38	27	166	12	88	26

Note) Please refer to the ST type for other dimensions.

Single Protrusion Clevis (CA) <Port side access type only>

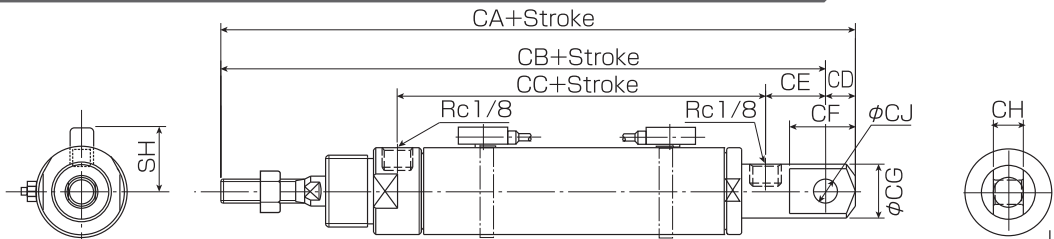

Units:mm

Symbol	CA	CB	CC	CD	CE	CF	φCG	CH	φCJ	Switch SH
φ20	174	164	85	10	20	22	18	10 _{-0.2}	8 ^{+0.02} ₀	22
φ25	182	169	85	13	25	30	22	12 _{-0.2}	10 ^{+0.02} ₀	24.5
φ30	196	181	88	15	27	33	26	14 _{-0.2}	12 ^{+0.02} ₀	27

Note) Please refer to the ST type for other dimensions.

Head Side Trunnion (TA)

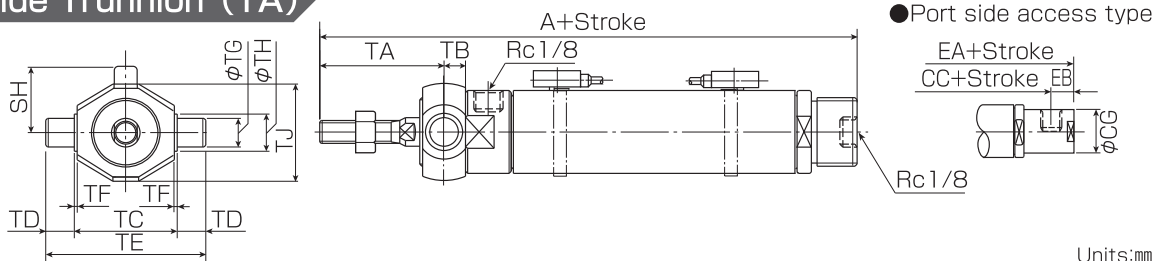

Units:mm

Symbol	A	TA	TB	TC	TD	φTE	TF	φTG	φTH	TJ	Switch SH	Port side access type			
Bore												EA	EB	CC	φCG
φ20	150	43.5 _{-0.8}	7.5 ^{+0.8} ₀	36±0.1	10	56±0.2	1	10 _{-0.02}	13	34	22	155	11	85	18
φ25	150	43.5 _{-0.8}	7.5 ^{+0.8} ₀	36±0.1	10	56±0.2	1	10 _{-0.02}	13	34	24.5	155	11	85	22
φ30	160	50.0 _{-0.8}	8.0 ^{+0.8} ₀	42±0.1	12	66±0.2	1	12 _{-0.02}	14	39	27	166	12	88	26

Note) Please refer to the ST type for other dimensions.

MINI Series

MRK70 Series ■ 7MPa

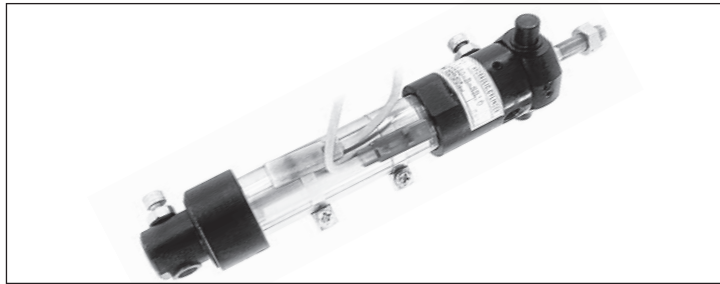

Specifications

Series Name	MRK70		
Bore	φ20·φ25·φ30		
Nominal Pressure	7MPa		
Proof Pressure	10.5MPa		
Minimum Working Pressure	0.3MPa		
Range of Operating Speed	10 to 300mm/s		
Range of Operating Temperature	-10°C to +60°C		
Hydraulic Oil Applied	General purpose mineral hydraulic oil		
Thread Tolerance	JIS6g/6H		
Stroke Tolerance (Grade A) Units:mm	100 and below	101 to 250	251 to 300
	+0.8 0	+1.0 0	+1.25 0

Note) The phosphoric acid ester cannot be used for the hydraulic fluid.

Standard Stroke

Stroke	Units:mm							
	25	50	75	100	150	200	Maximum	
Bore	φ20	○	○	○	○	○	○	300
	φ25	○	○	○	○	○	○	300
	φ30	○	○	○	○	○	○	300

Note) Able to produce any stroke by maximum stroke.

Switch Specifications

Type	10
Rated Voltage	AC/DC5 to 100V
Rated Current	5 to 50mA (Indicator Lamp is red 3 to 50mA)
Maximum Contact Capacity	AC/DC 10VA
Closed Circuit Voltage Drops	2.5V or less
Impact Resistance	30G
Lead Length	Side access Standard length : 1 m (Special order : 5 m)
Indicator Lamp	LED lights at all aspects ON.
Leak Current at OFF	0
Contact Dielectric Strength	200 VDC for one minute, Leak current: 1 mA or less
Protective construction	IP67

Note 1) To select a switch, check the current rating of the small relay coil, and the input current of PLC (programmable controller), and use the switch within the above operating current range.

Note 2) "Type 10" provides IP68 enclosure rating. It shall be tested depending on submersion depth.

Note 3) Red and green switches are available. There is no difference in performance.

Minimum stroke that can install switch

▶ In case of one switch : 10mm

▶ In case of two switches : 25mm

Code

MRK70 - 1 LB 25×25 B A - SB 101 - T

① ② ③ ④ ⑤ ⑥ ⑦ ⑧ ⑨ ⑩

① Series Name	MRK70
② Packing Material	1:Nitrile Rubber
③ Mounting	Basic (ST) Axis Direction Foot (LB) Head Side: Flange (FA) Single Protrusion Clevis (CA) Head Side Trunnion (TA)
④ Bore (mm)	20·25·30
⑤ Stroke Length (mm)	Indicate the stroke. (1-mm step, until 300 mm)
⑥ Cushion Format	R:Cushion on Head side H:Cushion on Cap side B:Cushion on both sides (Standard) N:None
⑦ Cushion valve location ^{Note)}	No notation : Standard (C position) A:A position B:B position
⑧ Switch Quantity	SO: No switch SR: Head-side switch (1 piece) SH: Cap-side switch (1 piece) SB: Two switches SC: Three switches
⑨ Switch Code	101:10 type, 1m cord (Standard) 105:10 type, 5m cord (Standard Equivalent)
⑩ End Joint	T:Single Protrusion End Joint Y:Double Protrusion End Joint

Note) The standard cushion valve position is shown in the outer dimension drawing. If the cushion valve position is different from the standard position, specify the "A", "B" or "C" symbol shown in the figure.

MINI Series

MRK70 Series ■ 7MPa

Basic Type [ST]

■ With Mounting Nut

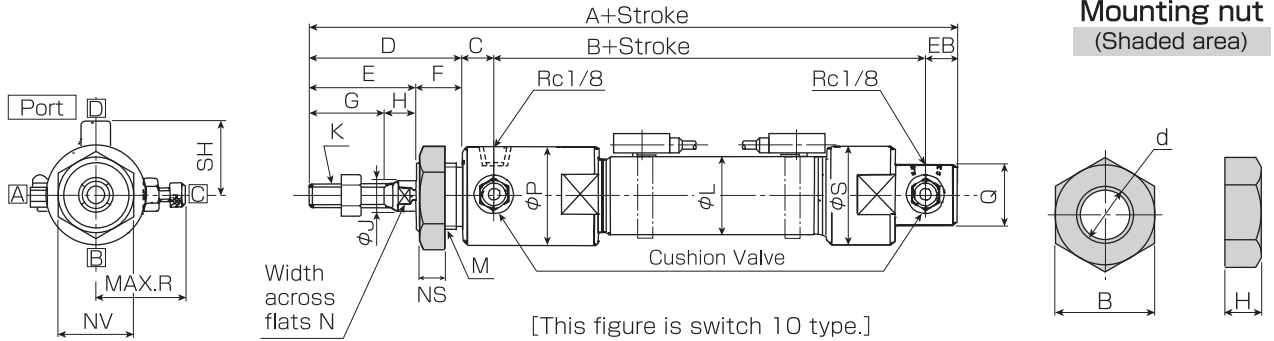

Units:mm

Symbol Bore	A	B	C	D	E	F	G	H	φJ	K	φL	M	N	φP	φQ	Switch SH	EB	R	NS	NV	φS
	φ20	166	95	10	51	35	16	25	10	10	M8 P1.0	26	M24 P1.5	8	33	22	22	10	30.5	8	30
φ25	167	94	10	53	37	16	25	12	12	M10 P1.25	31	M26 P1.5	10	38	26	24.5	10	34	8	32	42
φ30	191	105	10	66	44	22	30	14	14	M12 P1.25	36	M33 P1.5	12	43	30	27	10	36	8	41	46

Units:mm

Symbol Bore	d	H	B
	φ20	M24 P1.5	8
φ25	M24 P1.5	8	32
φ30	M26 P1.5	8	41

■ End Joint

Single Protrusion End Joint : T type

Double Protrusion End Joint: Y type
: Pin, Washer, Split pin

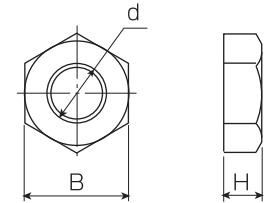
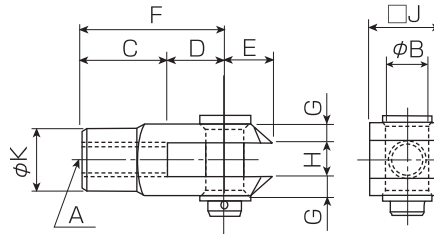
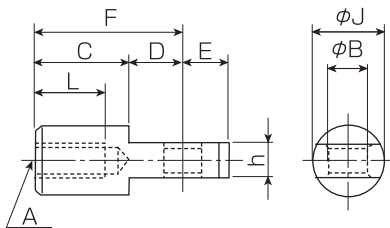

Units:mm

Symbol Bore	A	B bore dia	B shaft dia	C		D		E		F	G	H	h	□J/ φJ	φK	L
				Y joint	T joint	Y joint	T joint	Y joint	T joint							
φ20	M8 P1.0	8 ^{+0.022} ₀	8 ^{-0.013} _{-0.035}	16	20	16	12	10	10	32	4	8 ^{+0.1} ₀	8 ⁰ _{-0.1}	16	14	14.0
φ25	M10 P1.25	10 ^{+0.022} ₀	10 ^{-0.013} _{-0.035}	20	25	20	15	12	12	40	5	10 ^{+0.1} ₀	10 ⁰ _{-0.1}	20	18	17.5
φ30	M12 P1.25	12 ^{+0.027} ₀	12 ^{-0.016} _{-0.043}	24	30	24	18	14	14	48	6	12 ^{+0.2} ₀	12 ⁰ _{-0.2}	24	20	21.0

Units:mm

Symbol Bore	d	H	B
	φ20	M8 P1.0	6.5
φ25	M10 P1.25	8	17
φ30	M12 P1.25	10	19

Axis Direction Foot (LB)

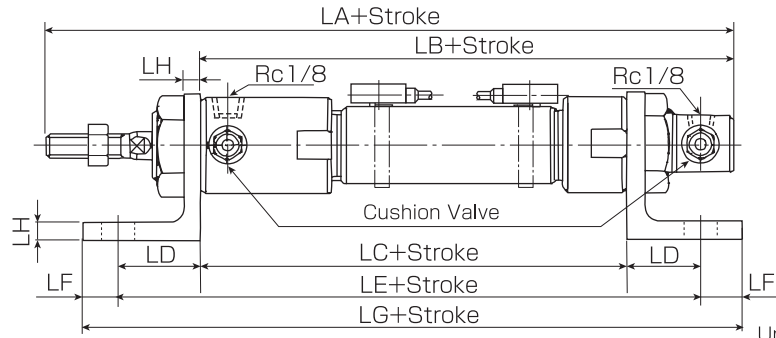
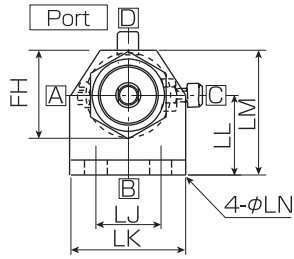

Symbol Bore	LA	LB	LC	LD	LE	LF	LG	LH	LJ	LK	LL	LM	φLN	FH
φ20	181	130	94	30	154	10	174	6	26	46	32	50	9	35
φ25	183	130	93	30	153	10	173	6	26	46	32	50	9	38
φ30	212	146	104	34	172	11	194	9	30	50	40	65	11	48

Note) Please refer to the ST type for other dimensions.

Head Side Flange (FA)

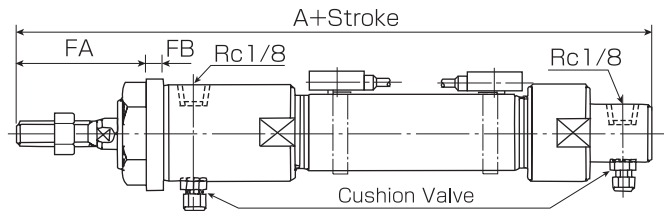
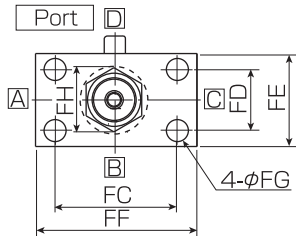

Symbol Bore	A	FA	FB	FC	FD	FE	FF	φFG	FH
φ20	166	45	6	50	25	38	66	9	35
φ25	167	47	6	50	25	38	66	9	38
φ30	191	54	12	62	31	50	82	11	48

Note) Please refer to the ST type for other dimensions.

Single Protrusion Clevis (CA) <Port side access type only>

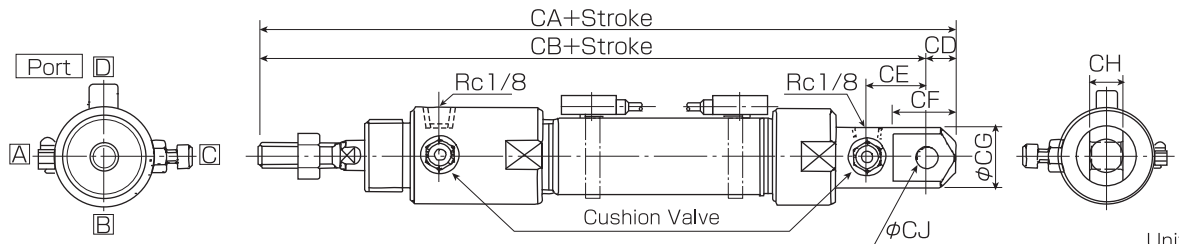

Symbol Bore	CA	CB	CD	CE	CF	φCG	φCJ	CH
φ20	186	176	10	20	22	22	8 ^{+0.02} ₀	10 ^{-0.2} ₀
φ25	196	183	13	26	30	26	10 ^{+0.02} ₀	12 ^{-0.2} ₀
φ30	223	208	15	27	33	30	14 ^{+0.018} ₀	15 ^{-0.2} ₀

Note) Please refer to the ST type for other dimensions.

Head Side Trunnion (TA)

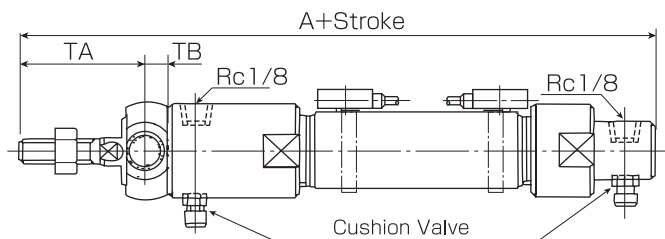
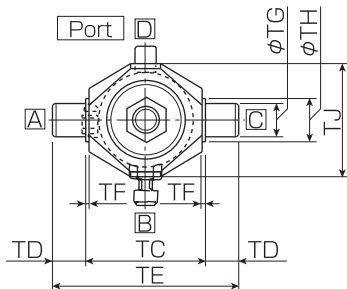

Symbol Bore	A	TA	TB	TF	TC	TD	TE	φTG	φTH	TJ
φ20	166	43.5	7.5	1	36±0.1	10	56	10 ^{-0.02} ₀	13	34
φ25	167	45	8	1	42±0.1	12	66	12 ^{-0.02} ₀	14	39
φ30	191	55	11	1	52±0.1	14	80	18 ^{-0.02} ₀	20	49

Note) Please refer to the ST type for other dimensions.

MINI Series

M140 Series ■ 14MPa

F series

K series

T series

C series

MINI series Switch specifications



Specifications

Series Name	Single rod type:M140S	Double rod type:M140D	
Bore	φ15·φ20·φ25·φ30		
Nominal Pressure	14MPa		
Proof Pressure	21MPa		
Minimum Working Pressure	0.5MPa or less		
Range of Operating Speed	10 to 300mm/s		
Range of Operating Temperature	-10°C to +80°C		
Cushion Format	Cushion stroke 17mm (option)		
Hydraulic Oil Applied	General purpose mineral hydraulic oil		
Thread Tolerance	JIS6g/6H		
Stroke Tolerance (Grade A) Units:mm	100 and below	101 to 250	251 to 300
	+0.8 0	+1.0 0	+1.25 0

Note) Please refer to the <Attention when using it> on P.179 for the application hydraulic fluid.

Standard Stroke

Stroke	Units:mm				Maximum
	25	50	75	100	
Bore	φ15	○	○	○	300
	φ20	○	○	○	300
	φ25	○	○	○	300
	φ30	○	○	○	300

Note) Able to produce any stroke which between 25mm~300mm.

Code

M140S - 1 LB 25×25 E B A - T - J

① ② ③ ④ ⑤ ⑥ ⑦ ⑧ ⑨ ⑩

① Series Name	M140S:Single rod type M140D:Double rod type												
② Packing Material	1:Nitrile Rubber												
③ Mounting	<table border="0"> <tr> <td>Basic (ST)</td> <td>Axis Direction Foot (LB)</td> <td>Head Side: Flange (FA)</td> <td>Single Protrusion Clevis (CA)</td> <td>Head Side Trunnion (TA)</td> <td>Cap Side Trunnion (TB)</td> </tr> <tr> <td></td> <td></td> <td></td> <td></td> <td></td> <td></td> </tr> </table>	Basic (ST)	Axis Direction Foot (LB)	Head Side: Flange (FA)	Single Protrusion Clevis (CA)	Head Side Trunnion (TA)	Cap Side Trunnion (TB)						
Basic (ST)	Axis Direction Foot (LB)	Head Side: Flange (FA)	Single Protrusion Clevis (CA)	Head Side Trunnion (TA)	Cap Side Trunnion (TB)								
④ Bore (mm)	15·20·25·30												
⑤ Stroke Length (mm)	Indicate the stroke. (1-mm step, until 300 mm)												
⑥ Port Location	No notation:Standard E: Cap-side port side access (ST, FA and TA only) The double rod type provides Cap-side port side access type only. (No specific code is required.)												
⑦ Presence of cushion	No notation:No Cushion B:Cushion on both sides H:Cushion on Cap side R:Cushion on Head side												
⑧ Cushion valve location	No notation:Standard (C position) A:A position B:B position												
⑨ End Joint	T:Single Protrusion End Joint Y:Double Protrusion End Joint												
⑩ Bellows	No notation:None J:With Bellows												

Note 1) Please refer to the dimensional outline drawing for the port position.

Note 2) There is no cushion of 15mm in inside diameter of cylinder.

Note 3) The standard cushion valve position is shown in the outer dimension drawing. If the cushion valve position is different from the standard position, specify the "A", "B" or "C" symbol shown in the figure.

Note 4) When the stroke is 25mm or less, it applies to the dimension of the stroke 25mm.

Basic Type [ST]

With Mounting Nut

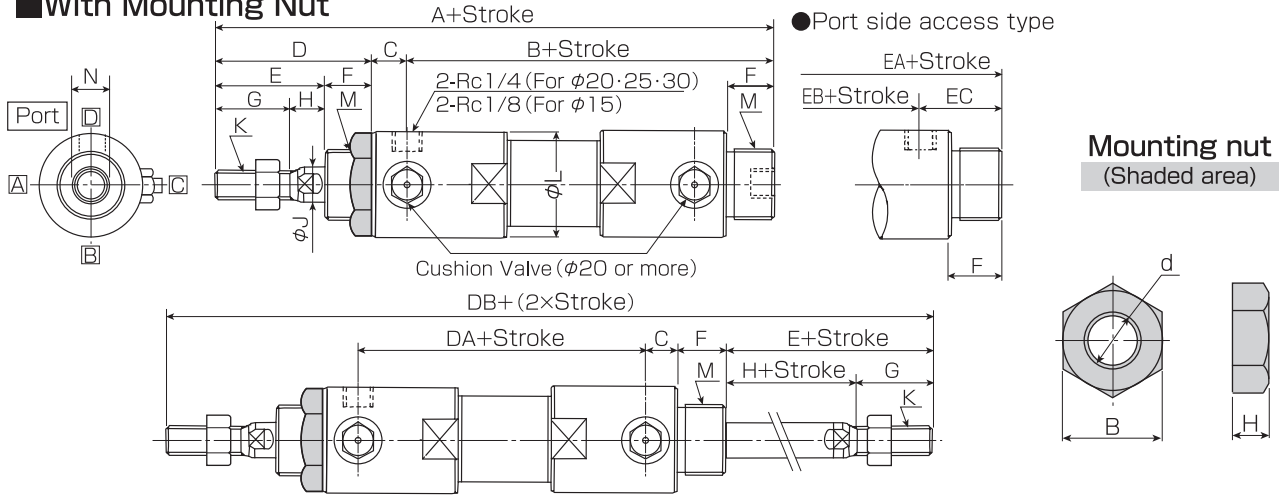

When the stroke is 25mm or less, it applies to the dimension of the stroke 25mm.

Symbol Bore	Units:mm														Units:mm			
	A	B	C	D	E	F	G	H	φJ	K	φL	M	N	Port side access type			Double Rod	
														EA	EB	EC	DA	DB
φ15	112	57	8	47	31	16	20	11	10	M8 P1.0	30	M24 P1.5	8	120	41	24	41	151
φ20	150	83	12	55	37	18	25	12	12	M10 P1.25	36	M26 P1.5	10	150	53	30	56	190
φ25	163	87	12	64	42	22	30	12	14	M12 P1.25	42	M33 P1.5	12	163	53	34	56	208
φ30	185	101	12	72	50	22	35	15	16	M14 P1.5	48	M33 P1.5	14	185	67	34	70	238

Symbol Bore	Units:mm		
	d	H	B
φ15	M24 P1.5	8	30
φ20	M26 P1.5	8	32
φ25	M33 P1.5	10	41
φ30	M33 P1.5	10	41

Note) Each dimension with the mounting lug is the same as the single rod type.

With Bellows (Material: Nylon tarporin, Heat resistance: 80°C)

Example 1: Foot (LB)

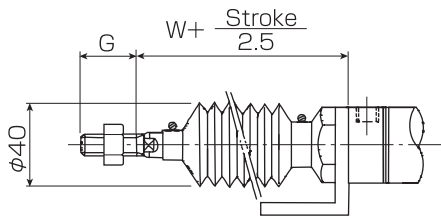

Example 2: Trunnion (TA)

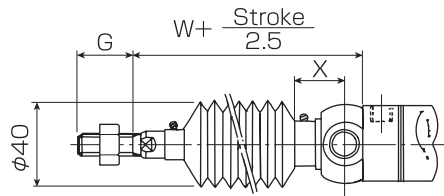

Symbol Bore	Units:mm		
	W	G	X
φ15	55	20	23
φ20	59	25	25
φ25	67	30	25
φ30	67	35	25

Note) For a cylinder with 37.5 mm or shorter stroke (with dust cover), calculate "W + 15".

End Joint

Single Protrusion End Joint : T type

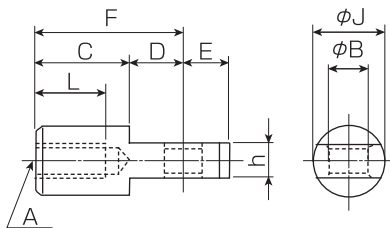

Double Protrusion End Joint: Y type : Pin, Washer, Split pin

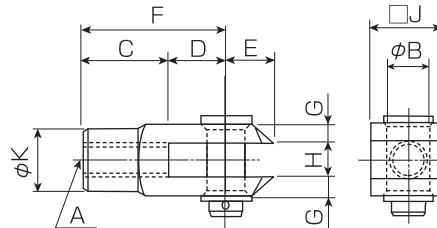

Lock Nut

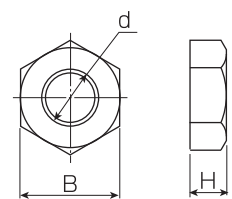

Symbol Bore	A	B bore dia	B shaft dia	Units:mm						□J/φJ	φK	L				
				C		D		E								
				Y joint	T joint	Y joint	T joint	Y joint	T joint	F	G	H	h			
φ15	M8 P1.0	8 ^{+0.022} ₀	8 ^{-0.013} _{-0.035}	16	20	16	12	10	10	32	4	8 ^{+0.1} ₀	8 ⁰ _{-0.1}	16	14	14.0
φ20	M10 P1.25	10 ^{+0.022} ₀	10 ^{-0.013} _{-0.035}	20	25	20	15	12	12	40	5	10 ^{+0.1} ₀	10 ⁰ _{-0.1}	20	18	17.5
φ25	M12 P1.25	12 ^{+0.027} ₀	12 ^{-0.016} _{-0.043}	24	30	24	18	14	14	48	6	12 ^{+0.2} ₀	12 ⁰ _{-0.2}	24	20	21.0
φ30	M14 P1.5	14 ^{+0.027} ₀	14 ^{-0.016} _{-0.043}	28	35	28	21	16	16	56	6.5	14 ^{+0.2} ₀	14 ⁰ _{-0.2}	27:□J 28:φJ	24	24.5

Symbol Bore	Units:mm		
	d	H	B
φ15	M8 P1.0	6.5	13
φ20	M10 P1.25	8	17
φ25	M12 P1.25	10	19
φ30	M14 P1.5	11	22

MINI Series

M140 Series ■ 14MPa

F series

K series

T series

C series

Switch specifications

MINI series

Axis Direction Foot (LB)

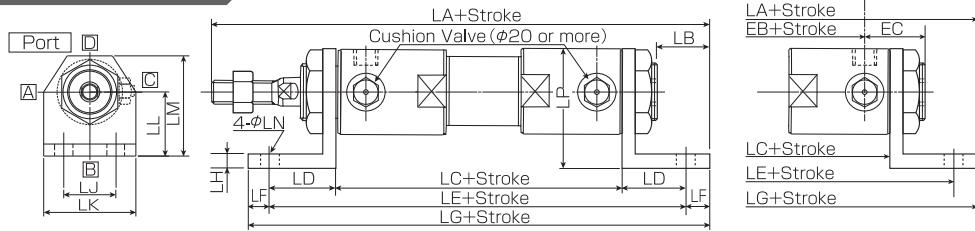

When the stroke is 25mm or less, it applies to the dimension of the stroke 25mm.

Units:mm

Symbol Bore	LA	LB	LC	LD	LE	LF	LG	LH	LJ	LK	LL	LM	φLN	LP	Port side access type					
	LA	EB	EC	LC	LE	LG	LA	EB	EC	LC	LE	LG								
φ15	136	24	49	30	109	10	129	6	26	46	32	50	9	47	144	41	24	57	117	137
φ20	172	22	77	30	137	10	157	6	26	46	32	50	9	50	172	53	30	77	137	157
φ25	186	23	77	34	145	11	167	9	30	50	40	65	11	61	186	53	34	77	145	167
φ30	208	23	91	34	159	11	181	9	30	50	40	65	11	64	208	67	34	91	159	181

Note) Please refer to the ST type for other dimensions.

Head Side Flange (FA)

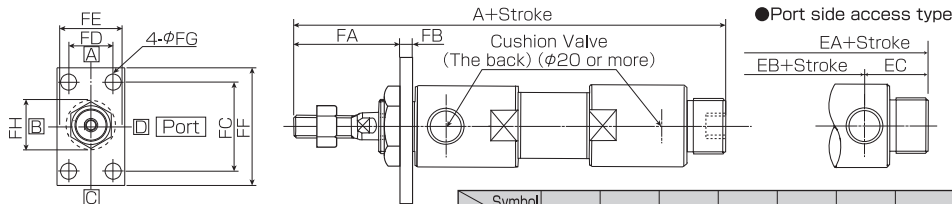

Units:mm

When the stroke is 25mm or less, it applies to the dimension of the stroke 25mm.

Symbol Bore	A	FA	FB	FC	FD	FE	FF	φFG	FH	Port side access type		
	EA	EB	EC									
φ15	112	41	6	50	25	38	66	9	35	120	41	24
φ20	150	46	9	55	25	38	71	9	38	150	53	30
φ25	163	52	12	62	31	50	82	11	48	163	53	34
φ30	185	60	12	62	31	50	82	11	48	185	67	34

Note) Please refer to the ST type for other dimensions.

Single Protrusion Clevis (CA) <Port side access type only>

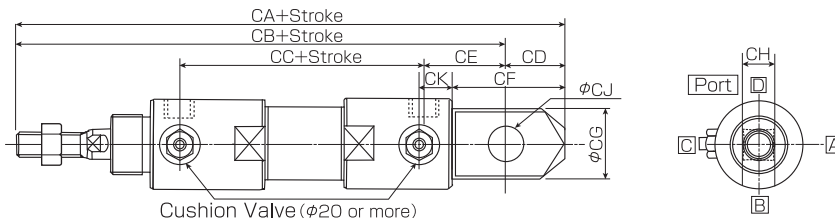

Units:mm

When the stroke is 25mm or less, it applies to the dimension of the stroke 25mm.

Symbol Bore	CA	CB	CC	CD	CE	CF	φCG	CH	φCJ	CK
	φ15	135	122	41	13	26	30.5	26	12 ^{-0.1} _{-0.3}	10 ^{+0.02} ₀
φ20	171	155	56	16	32	35.5	28	14 ^{-0.1} _{-0.3}	12 ^{+0.02} ₀	12.5
φ25	184	167	56	17	35	39.5	31	18 ^{-0.1} _{-0.3}	16 ^{+0.02} ₀	13.5
φ30	214	194	70	20	40	47.5	38	20 ^{-0.1} _{-0.3}	18 ^{+0.02} ₀	15.5

Note) Please refer to the ST type for other dimensions.

Head Side Trunnion (TA)

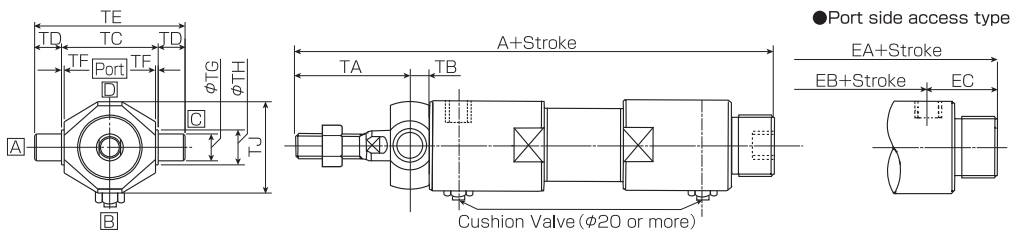

When the stroke is 25mm or less, it applies to the dimension of the stroke 25mm.

Units:mm

Symbol Bore	A	TA	TB	TC	TD	TE	TF	φTG	φTH	TJ	Port side access type		
	EA	EB	EC										
φ15	112	39.5	7.5 ^{+0.8} ₀	36±0.1	10	56±0.2	1	10 ⁰ _{-0.02}	13	34	120	41	24
φ20	150	47.0	8.0 ^{+0.8} ₀	42±0.1	12	66±0.2	1	12 ⁰ _{-0.02}	14	39	150	53	30
φ25	163	53.0	11.0 ^{+0.8} ₀	52±0.1	14	80±0.2	1	18 ⁰ _{-0.02}	20	49	163	53	34
φ30	185	61.0	11.0 ^{+0.8} ₀	52±0.1	14	80±0.2	1	18 ⁰ _{-0.02}	20	49	185	67	34

Note) Please refer to the ST type for other dimensions.



Specifications

Series Name	M210		
Bore	φ15·φ20·φ25·φ30		
Nominal Pressure	21MPa		
Proof Pressure	31.5MPa		
Minimum Working Pressure	0.7MPa以下		
Range of Operating Speed	10 to 200mm/s		
Range of Operating Temperature	-10°C to +80°C		
Cushio Format	None		
Hydraulic Oil Applied	General purpose mineral hydraulic oil		
Thread Tolerance	JIS6g/6H		
Stroke Tolerance (Grade A) Units:mm	100 and below +0.8 0	101 to 250 +1.0 0	251 to 300 +1.25 0

Standard Stroke

		Units:mm				
Stroke	25	50	75	100	Maximum	
Bore	φ15	○	○	○	○	300
	φ20	○	○	○	○	300
	φ25	○	○	○	○	300
	φ30	○	○	○	○	300

Note) Able to produce any stroke by maximum stroke.

Note) Please refer to the <Attention when using it> on P.179 for the application hydraulic fluid.

Code

M210 - 1 LB 25×25 E - T - J

① ② ③ ④ ⑤ ⑥ ⑦ ⑧

① Series Name	M210				
② Packing Material	1:Nitrile Rubber				
③ Mounting	Basic (ST) - ■■■■	Axis Direction Foot (LB) - ■■■■	Head Side: Flange (FA) - ■■■■	Single Protrusion Clevis (CA) - ■■■■	Head Side Trunnion (TA) - ■■■■
④ Bore (mm)	15·20·25·30				
⑤ Stroke Length (mm)	Indicate the stroke. (1-mm step, until 300 mm)				
⑥ Port Location	No notation : Standard E: Cap-side port, side access (ST, FA and TA only)				
⑦ End Joint	T:Single Protrusion End Joint Y:Double Protrusion End Joint				
⑧ Bellows	No notation : None J:With Bellows				

Note 1) Please refer to the dimensional outline drawing for the port position.

Note 2) When the stroke is 25mm or less, it applies to the dimension of the stroke 25mm.

MINI Series

M210 Series ■ 21MPa

Basic Type [ST]

■ With Mounting Nut

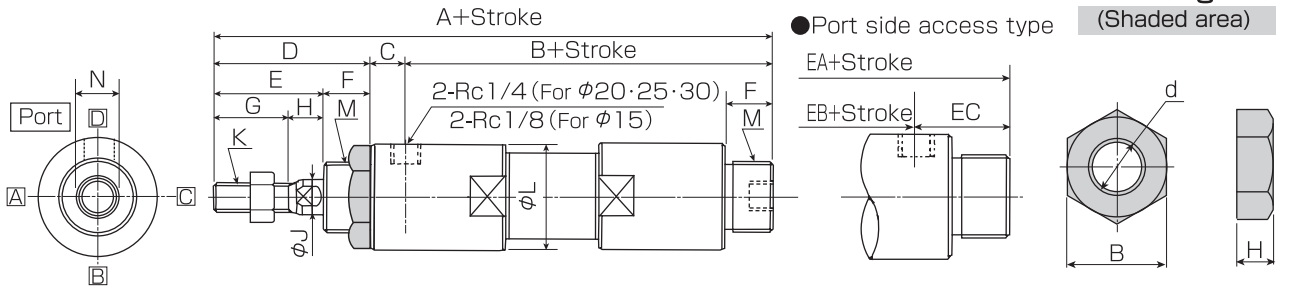

Units:mm

Symbol Bore	A	B	C	D	E	F	G	H	φJ	K	φL	M	N	Port side access type		
	EA	EB	EC													
φ15	112	57	8	47	31	16	20	11	10	M8 P1.0	30	M24 P1.5	8	120	41	24
φ20	150	83	12	55	37	18	25	12	12	M10 P1.25	36	M26 P1.5	10	150	53	30
φ25	163	87	12	64	42	22	30	12	16	M14 P1.5	42	M33 P1.5	14	163	53	34
φ30	185	101	12	72	50	22	35	15	18	M16 P1.5	48	M33 P1.5	16	185	67	34

Units:mm

Symbol Bore	d	H	B
φ15	M24 P1.5	8	30
φ20	M26 P1.5	8	32
φ25	M33 P1.5	10	41
φ30	M33 P1.5	10	41

■ With Bellows (Material: Nylon tarporin, Heat resistance: 80°C)

Example 1: Foot (LB)

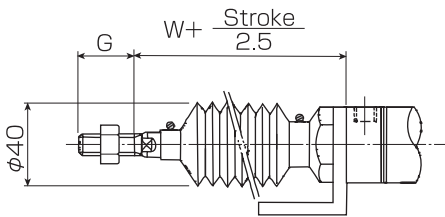

Example 2: Trunnion (TA)

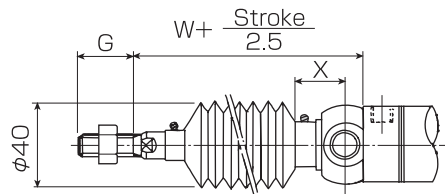

Units:mm

Symbol Bore	W	G	X
φ15	55	20	23
φ20	59	25	25
φ25	67	30	25
φ30	67	35	25

Note) For a cylinder with 37.5 mm or shorter stroke (with dust cover), calculate "W + 15".

■ End Joint

Single Protrusion End Joint : T type

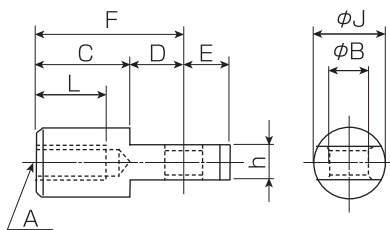

Double Protrusion End Joint: Y type
: Pin, Washer, Split pin

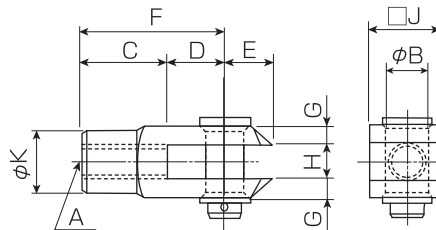

Units:mm

Symbol Bore	A	B bore dia	B shaft dia	C					D	E	F	G	H	h	φJ/φJ	φK	L
				Y joint	T joint	Y joint	T joint	Y joint	T joint								
φ15	M8 P1.0	8 ^{+0.022} ₀	8 ^{+0.013} _{-0.035}	16	20	16	12	10	10	32	4	8 ^{+0.1} ₀	8 ⁰ _{-0.1}	16	14	14.0	
φ20	M10 P1.25	10 ^{+0.022} ₀	10 ^{+0.013} _{-0.035}	20	25	20	15	12	12	40	5	10 ^{+0.1} ₀	10 ⁰ _{-0.1}	20	18	17.5	
φ25	M14 P1.5	14 ^{+0.027} ₀	14 ^{-0.016} _{-0.043}	28	35	28	21	16	16	56	6.5	14 ^{+0.2} ₀	14 ⁰ _{-0.2}	27:φJ 28:φJ	24	24.5	
φ30	M16 P1.5	16 ^{+0.027} ₀	16 ^{-0.016} _{-0.043}	32	40	32	24	19	19	64	8	16 ^{+0.2} ₀	16 ⁰ _{-0.2}	32	26	28.0	

Units:mm

Lock Nut

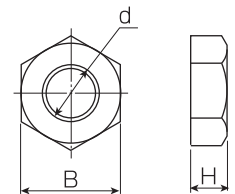

Axis Direction Foot (LB)

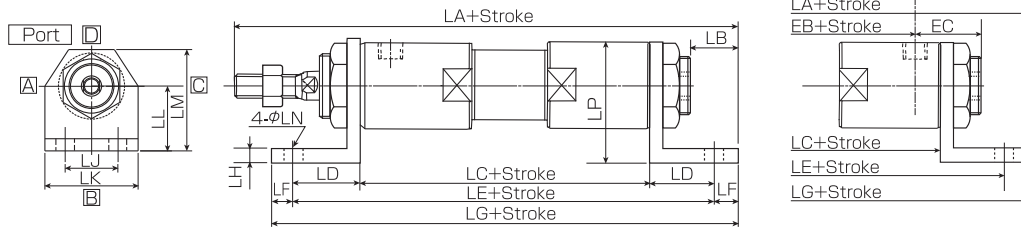

When the stroke is 25mm or less, it applies to the dimension of the stroke 25mm.

Units:mm

Symbol Bore	LA	LB	LC	LD	LE	LF	LG	LH	LJ	LK	LL	LM	ϕ LN	LP	Port side access type					
															LA	EB	EC	LC	LE	LG
$\phi 15$	136	24	49	30	109	10	129	6	26	46	32	50	9	47	144	41	24	57	117	137
$\phi 20$	172	22	77	30	137	10	157	6	26	46	32	50	9	50	172	53	30	77	137	157
$\phi 25$	186	23	77	34	145	11	167	9	30	50	40	65	11	61	186	53	34	77	145	167
$\phi 30$	208	23	91	34	159	11	181	9	30	50	40	65	11	64	208	67	34	91	159	181

Head Side Flange (FA)

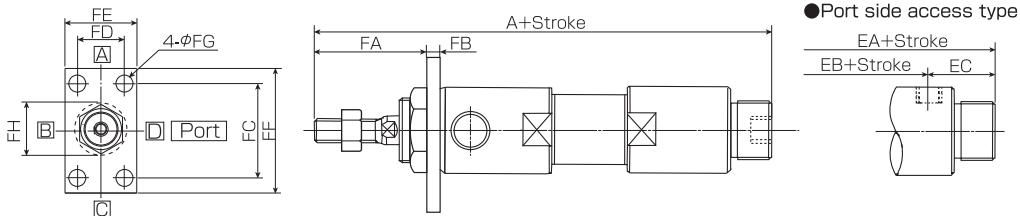

When the stroke is 25mm or less, it applies to the dimension of the stroke 25mm.

Units:mm

Symbol Bore	A	FA	FB	FC	FD	FE	FF	ϕ FG	FH	Port side access type		
										EA	EB	EC
$\phi 15$	112	41	6	50	25	38	66	9	35	120	41	24
$\phi 20$	150	46	9	55	25	38	71	9	38	150	53	30
$\phi 25$	163	52	12	62	31	50	82	11	48	163	53	34
$\phi 30$	185	60	12	62	31	50	82	11	48	185	67	34

Single Protrusion Clevis (CA) <Port side access type only>

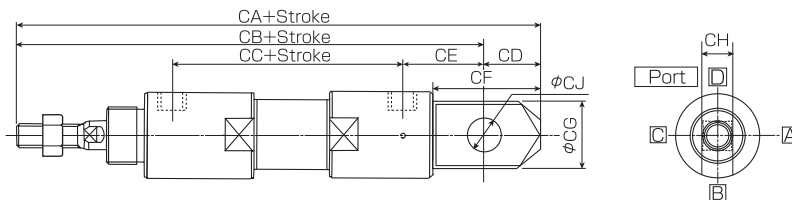

When the stroke is 25mm or less, it applies to the dimension of the stroke 25mm.

Units:mm

Symbol Bore	CA	CB	CC	CD	CE	CF	ϕ CG	CH	ϕ CJ
	$\phi 15$	135	122	41	13	26	30.5	26	12 $_{-0.3}^{-0.1}$
$\phi 20$	171	155	56	16	32	35.5	28	14 $_{-0.3}^{-0.1}$	12 $_{0}^{+0.02}$
$\phi 25$	184	167	56	17	35	39.5	31	18 $_{-0.3}^{-0.1}$	16 $_{0}^{+0.02}$
$\phi 30$	214	194	70	20	40	47.5	38	20 $_{-0.3}^{-0.1}$	18 $_{0}^{+0.02}$

Head Side Trunnion (TA)

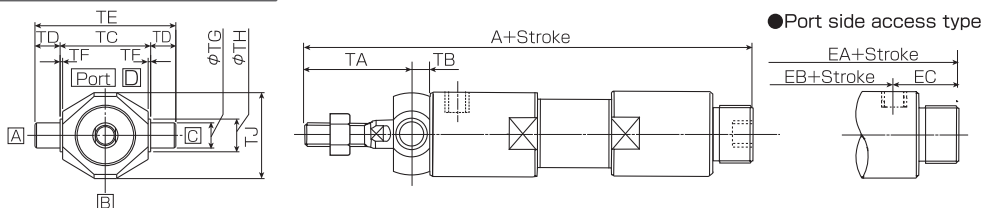

When the stroke is 25mm or less, it applies to the dimension of the stroke 25mm.

Units:mm

Symbol Bore	A	TA	TB	TC	TD	TE	TF	ϕ TG	ϕ TH	TJ	Port side access type		
											EA	EB	EC
$\phi 15$	112	39.5	7.5 $_{0}^{+0.8}$	36 ± 0.1	10	56 ± 0.2	1	10 $_{-0.02}^{0}$	13	34	120	41	24
$\phi 20$	150	47.0	8 $_{0}^{+0.8}$	42 ± 0.1	12	66 ± 0.2	1	12 $_{-0.02}^{0}$	14	39	150	53	30
$\phi 25$	163	53.0	11 $_{0}^{+0.8}$	52 ± 0.1	14	80 ± 0.2	1	18 $_{-0.02}^{0}$	20	49	163	53	34
$\phi 30$	185	61.0	11 $_{0}^{+0.8}$	52 ± 0.1	14	80 ± 0.2	1	18 $_{-0.02}^{0}$	20	49	185	67	34

MINI Series Mass Table

F series

K series

T series

C series

Switch specifications

MINI series

■MR35 Units: kg

Bore	Basic Mass (Stroke:O)					Stroke Mass per 10mm
	ST	LB	FA	CA	TA (TB)	
φ20	0.23	0.52	0.34	0.30	0.31	0.012
φ25	0.30	0.59	0.39	0.46	0.36	0.016
φ30	0.41	0.70	0.55	0.60	0.56	0.022

■MRK35 Units: kg

Bore	Basic Mass (Stroke:O)					Stroke Mass per 10mm
	ST	LB	FA	CA	TA (TB)	
φ20	0.32	0.61	0.43	0.39	0.40	0.012
φ25	0.40	0.69	0.49	0.56	0.46	0.016
φ30	0.53	0.82	0.67	0.73	0.68	0.020

■M70 Units: kg

Bore	Basic Mass (Stroke:O)										Stroke Mass per 10mm	
	ST		LB		FA		CA		TA (TB)			
	S	D	S	D	S	D	S	D	S	D	S	D
φ20	0.47	0.69	0.74	0.96	0.56	0.78	0.56	—	0.53	0.75	0.033	0.040
φ25	0.58	0.88	0.85	1.15	0.67	0.97	0.73	—	0.64	0.94	0.042	0.050
φ30	0.82	1.32	1.10	1.56	0.95	1.45	0.87	—	0.92	1.42	0.050	0.062

■MR70 Units: kg

Bore	Basic Mass (Stroke:O)					Stroke Mass per 10mm
	ST	LB	FA	CA	TA (TB)	
φ20	0.46	0.73	0.56	0.45	0.52	0.023
φ25	0.59	0.86	0.69	0.62	0.65	0.030
φ30	0.84	1.11	0.97	0.89	0.94	0.036

■MRK70 Units: kg

Bore	Basic Mass (Stroke:O)					Stroke Mass per 10mm
	ST	LB	FA	CA	TA (TB)	
φ20	0.65	0.92	0.75	0.74	0.78	0.023
φ25	0.80	1.07	0.80	0.84	0.88	0.030
φ30	1.14	1.69	1.39	1.31	1.35	0.036

■M140 Units: kg

Bore	Basic Mass (Stroke:O)										Stroke Mass per 10mm	
	ST		LB		FA		CA		TA (TB)			
	S	D	S	D	S	D	S	D	S	D	S	D
φ15	0.46	0.54	0.73	0.80	0.59	0.66	0.50	—	0.56	0.64	0.030	0.034
φ20	0.81	0.92	1.08	1.20	0.94	1.05	0.83	—	0.91	1.02	0.036	0.045
φ25	1.21	1.41	1.76	1.96	1.46	1.66	1.20	—	1.42	1.62	0.044	0.056
φ30	1.66	1.80	2.21	2.35	1.91	2.05	1.73	—	1.87	2.01	0.054	0.070

■M210 Units: kg

Bore	Basic Mass (Stroke:O)					Stroke Mass per 10mm
	ST	LB	FA	CA	TA	
φ15	0.47	0.74	0.60	0.50	0.57	0.030
φ20	0.83	1.10	0.96	0.85	0.93	0.036
φ25	1.22	1.77	1.47	1.19	1.43	0.044
φ30	1.72	2.27	1.97	1.78	1.93	0.079

Calculation Formula : Weight of cylinder (kg) = Basic weight + Addition weight ×Stroke/10 (mm)

MINI Series Pisron Area • Theoretical Output

■ MR35 • MRK35 • M70 • MR70 • MRK70

Units: N

Bore	Push • Pull	Piston Area (cm ²)	Theoretical Output	
			3.5MPa	7MPa
φ20	Push	3.1	1085	2170
	Pull	2.3	805	1610
φ25	Push	4.9	1715	3430
	Pull	3.7	1295	2590
φ30	Push	7.0	2450	4900
	Pull	5.4	1890	3780

■ M140

Units: N

Bore	Push • Pull	Piston Area (cm ²)	Theoretical Output
			14MPa
φ15	Push	1.7	2380
	Pull	0.9	1260
φ20	Push	3.1	4340
	Pull	2.0	2800
φ25	Push	4.9	6860
	Pull	3.3	4620
φ30	Push	7.0	9800
	Pull	5.0	7000

■ M210

Units: N

Bore	Push • Pull	Piston Area (cm ²)	Theoretical Output
			21MPa
φ15	Push	1.7	3570
	Pull	0.9	1890
φ20	Push	3.1	6510
	Pull	2.0	4200
φ25	Push	4.9	10290
	Pull	2.9	6090
φ30	Push	7.0	14700
	Pull	4.5	9450

MINI Series Attachment

Hose • Coupling

- Proof pressure : 21MPa
- Bore : 3.2mm
- Outside diameter : 8.2mm
- Both ends coupling
- Connected caliber : R1/8
- Minimum bend radius : 15mm
- Fluid contact part of hose : Nylon

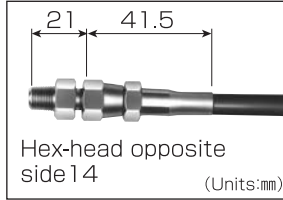

Hex-head opposite side 14 (Units:mm)

Straight

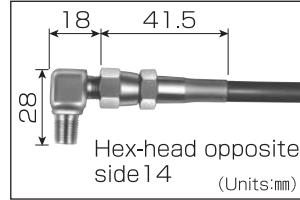

Hex-head opposite side 14 (Units:mm)

Elbow

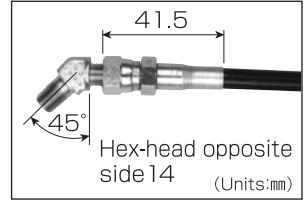

Hex-head opposite side 14 (Units:mm)

Elbow shape of 45°

Order sign

- Fluid contact part of hose

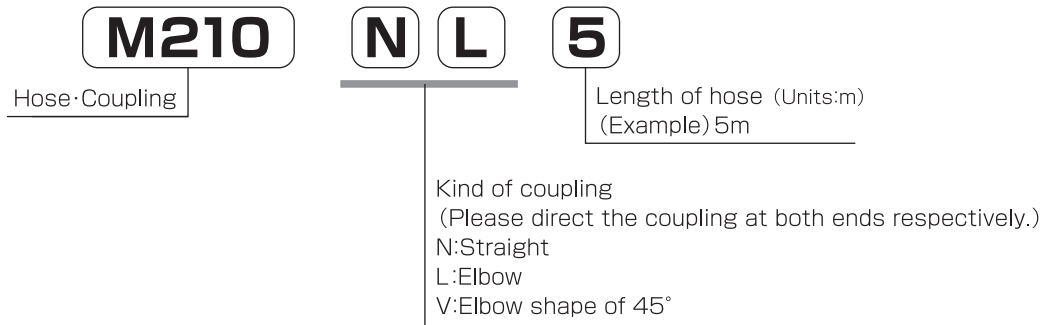

- Order example : For The length of the hose is 5m, The coupling at both ends is straight, Elbow

↓
M210-NL-5

MINI Series

Cushion adjustment / Switch working area and corresponding difference

Cushion adjustment

Enlarged view of cushion valve

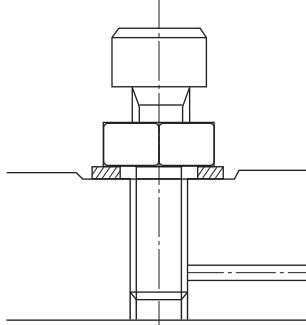

Adjusting method

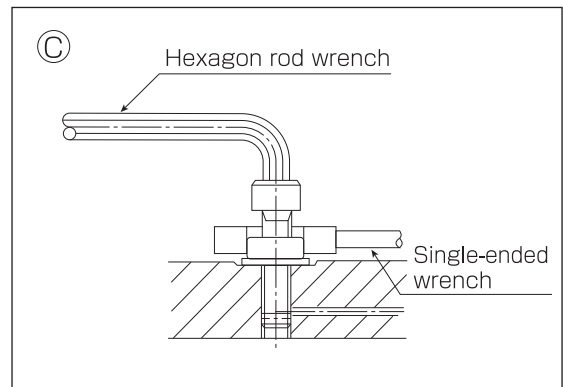
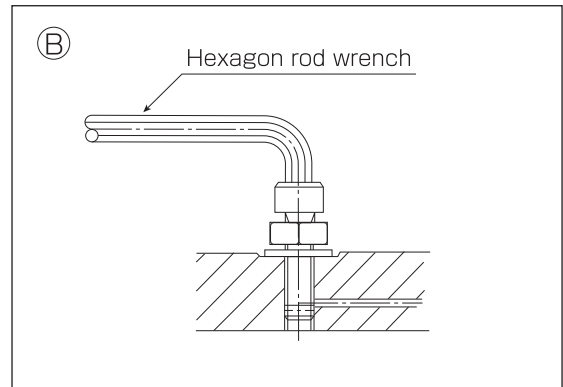
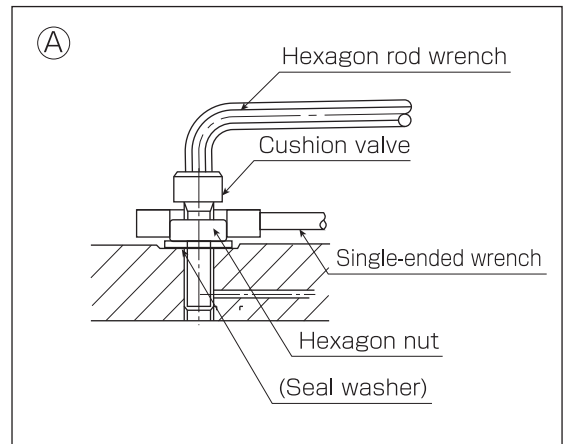

CAUTION

Before adjustment, make sure that hydraulic pressure is not applied to the cylinder.

- 1 Loosen the cushion nut by 1/4 counterclockwise turn with a single-ended wrench. (Figs. A and B)
- 2 If the cushion valve is turned clockwise with a hexagon rod wrench, the cushion speed lowers. Turning the cushion valve counterclockwise increases the cushion speed.



CAUTION

If the cushion valve is excessively turned clockwise, abnormal surge pressure may be generated. If the cushion valve is excessively turned counterclockwise, the cushion has no effect, and the cushion may come off when the cylinder operates. If you turn the cushion valve counterclockwise, make sure that the head of the cushion bolt does not protrude from the cylinder body by 13 mm or more.

- 3 After cushion valve adjustment is completed, tighten the hexagon nut with a single-ended wrench with the tightening torque given in the table below, while fastening the cushion valve with a hexagon rod wrench. (Fig. C)

Hexagon nut tightening torque	3.92 to 4.9 N·m
Width across flats of hexagon nut	10mm
Width across flats of hexagon rod wrench	4mm

Switch working area and corresponding difference

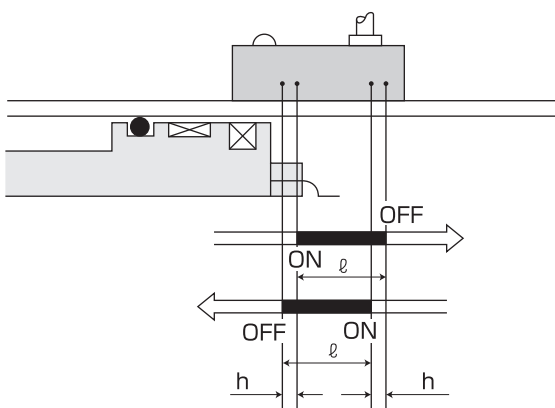

Operating distance (l) :

Range of piston stroke between the switch-ON position and the switch-OFF position in the same direction of the piston stroke

Hysteresis (h) :

Distance between the switch-ON position and the switch-OFF position in the reverse direction of the piston stroke.

		Units:mm	
Bore	Symbol	l	h
10 type		7 to 8	2 to 3

MINI Series Installation method and internal logic of switch

10 switch

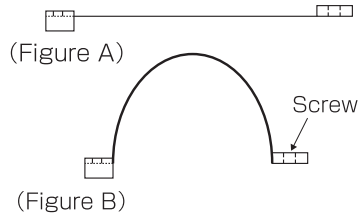

- ① Curve the band around the screw bracket. (Fig. B)

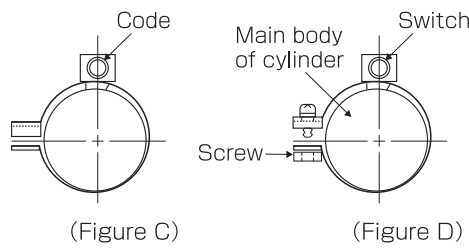

- ② Mount the switch at the top of the cylinder, with the screw bracket located nearly at 90- angle to the switch. (Fig. C)
For the switch of "Type 10", hook the band onto the bracket at the bottom of the switch. (Fig. C)
- ③ Insert a cross-recessed screw from the  - shaped bracket, to screw into the bracket on the mounting surface. (Fig. D)

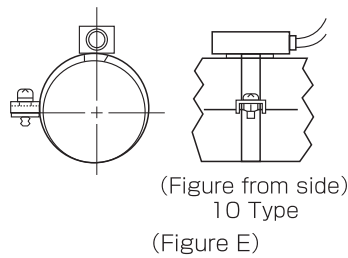

- ④ If the switch is fastened without shaking, the switch is properly mounted. (Fig. E)
(The screwdriver's tightening torque should be approx. 60 to 80 N·cm.)

Internal circuit chart of switch 10 Type

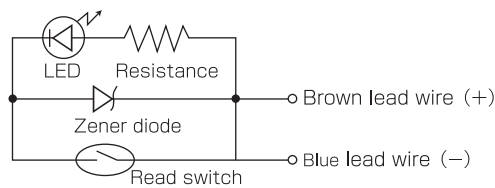

MINI Series "Mini Hydraulic Cylinder" Directions Point

The maximum stroke that can be used

Since the "MINI Series" cylinders provide a piston rod with a small diameter, the piston stroke is limited. Pay attention to "Maximum allowable stroke".

Calculating formula of The maximum stroke that can be used Mini Hydraulic Cylinder General form

"Maximum allowable stroke" (S) can be determined by the following the procedure below:

- ① Determine "coefficient of terminal" (n) from the terminal coefficient table.
- ② Determine an intersection (A) by extending a horizontal line from the intersection of "Pressure setting" and "Bore of Cylinder" and "Coefficient of terminal (n)" in the nomograph. Then, determine "Maximum mounting length (L)" on the line connecting the intersection (A) and "Piston rod diameter*".
- ③ Determine a mounting length (Lo) in retracted status from the outer dimension drawing, and calculate "Maximum stroke" (S) with the following formula:

$$S = L - L_o$$

S : Stroke (mm)
 L : Mounting length in extended status (mm)
 L_o * : Mounting length in retracted status (mm)

* Determine "Lo" from the outer dimension drawing for each type.

ex) M140 Series

Maximum allowable stroke (S) for mounting type "CA", under the conditions of "14 MPa pressure setting", "φ30 mm cylinder bore diameter" and "φ16 mm piston rod diameter" is determined as follows:

- ① $n = 1$ (as shown in terminal coefficient table)
- ② Apply the above conditions to the nomograph below. (See the broken line in the monograph.)
The line extended from intersection (A) passes through the rod diameter of φ16 mm, and you can determine the mounting length (L) in extended status. $L = 430$
- ③ According to the standard dimension drawing for the M140 series CA type:
 $L_o = 229$, and $S = L - L_o$.
Therefore, maximum allowable stroke (S) is determined at 201 mm ($S = 430 - 229 = 201$).

Nomograph used to determine maximum stroke

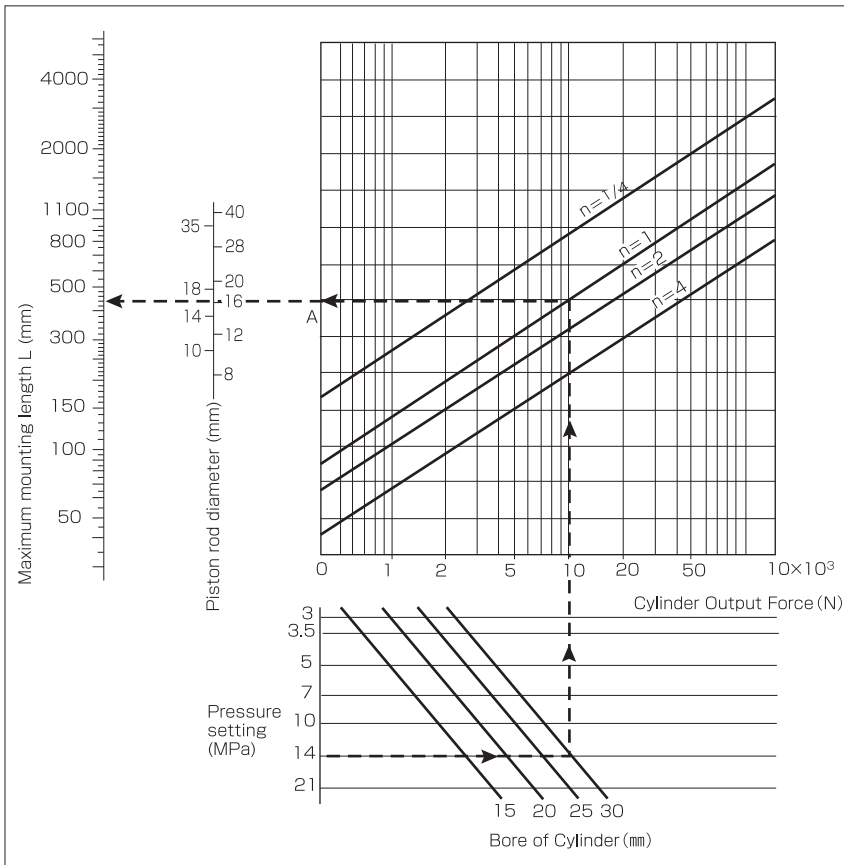

Note) If the maximum stroke exceeds 300 mm, please consult us.

Coefficient of terminal

Mounting	Use conditions	Coefficient of terminal (n)
LB		1/4
		2
		4
FA		1/4
		2
		4
CA		1
TA		1

Surge Pressure

The proof pressure of the cylinder during operation is calculated as 1.5 times larger than the maximum pressure for normal operation. However, in applications with high-speed valve switching and high-speed cylinder operation, "surge pressure" will be generated, which is several times higher than the normal operating pressure. For applications where high surge pressure is expected, you should select a cylinder that provides sufficiently high proof pressure.

Hydraulic Oil

To use general-purpose mineral hydraulic oil, select oil equivalent to JIS K2213 No. 1 or No. 2, and use the oil within a viscosity range of 20 to 400 cst. Synthetic hydraulic oil (e.g. phosphoric ester oil) can be used under conditions similar to those for general-purpose mineral hydraulic oil. However, the packing material should be fluoro rubber. Water-based hydraulic oil (e.g. water-glycol hydraulic oil, W/O emulsion oil) can be used in the same manner as general-purpose mineral hydraulic oil. However, the cylinder service life will be shortened.

Packing Material

Type of hydraulic oil	Packing Material	Nitrile Rubber	Fluoric Rubber
General-purpose Mineral Hydraulic Oil		○	○
Synthetic hydraulic oil		×	○
Aqueous formulation hydraulic fluid	Water-Glycol-type Operating Oil	○	×
	Emulsions of Water in Mineral Oil	○	○
	Emulsions of Mineral Hydraulic Oil in Water	○	○

- Note 1) indicates "Applicable". I indicates "Not applicable".
 Note 2) The operating temperature range for the packing is -10°C to +80°C.
 Note 3) Nitrile rubber is used as the standard material. To order fluoro rubber packing, please contact us separately. The packing shape changes depending on the material.



บริษัท นานดีอินเตอร์เทรด จำกัด
NANDEE INTER-TRADE CO., LTD.

314, 316, 318, 320, 322 ซอยจันทน์ 32 ถนนจันทน์ แขวงทุ่งวัดดอน เขตสาทร กทม. 10120
Tel : 0-2675-8230 (Auto), 0-2675-8240 (Auto) Fax : 0-2212-1448, 0-2213-0360

LINE : @nandeeintertrade
f : nandeeintertrade
✉ : info@nandee.co.th
🌐 : www.nandee.co.th

LINE @

