

# TONE®

TONE® Made in Japan





## HAND TOOLS เครื่องมือช่าง

Tool Set (Service Board with Shutter) แผงแขวนพร้อมเครื่องมือ (พร้อมบานสไลด์ปิด) .....	G3
Tool Cabinet Set ชุดตู้พร้อมเครื่องมือ .....	G4
Tool Cabin Set รถเข็นพร้อมเครื่องมือ .....	G5
Tool Box Set ชุดกล่องพร้อมเครื่องมือ .....	G6
Ball Point Hex Key Wrench (L-Type) ประแจหกเหลี่ยมหัวบอล .....	G8
Long Ball Point Hex Key Wrench (L-Type) ประแจหกเหลี่ยมหัวบอล .....	G9
Spanner Offset Wrench ประแจปากตาย .....	G10
Combination Wrench ประแจแควนข้างปากตาย .....	G11
Offset Wrench Long Type ประแจแควนแบบยาว .....	G12
Socket Wrench Set ชุดลูกบ็อกซ์พร้อมด้ามขันฟรี .....	G13
Torque Wrench ประแจปอนด์ .....	G14
Screwdriver ไขควง .....	G17
Other อื่นๆ .....	G18

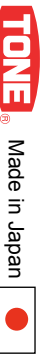

# TOOL SET ( SERVICE BOARD WITH SHUTTER )

## แผงแขวนพร้อมเครื่องมือ 89 ชิ้น ( พร้อมบานสไลด์ปิด )

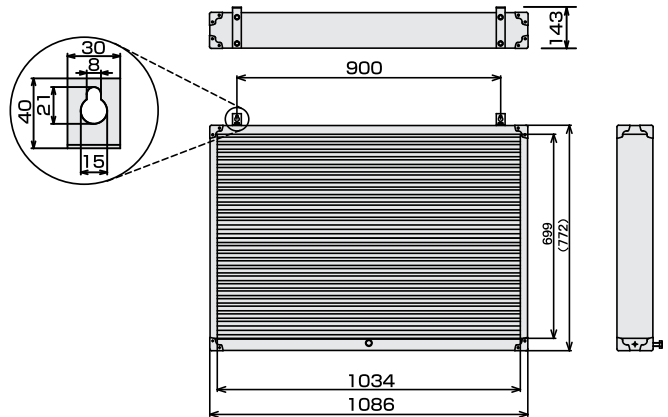
**111-89-C635(G)**

Made in Japan



TOOL SET

Product list		Item No.
ลูกบ็อกซ์ 1/4" (6pt.)	Socket 1/4" (6pt.)	2S- 05, 5.5, 07, 08, 10, 12
ลูกบ็อกซ์ 1/2" (6pt.)	Socket 1/2" (6pt.)	4S- 10, 12
ลูกบ็อกซ์ 1/2" (12pt.)	Socket 1/2" (12pt.)	4D- 13, 14, 17, 19, 21, 22, 24, 27, 30, 32
ด้ามขันฟรี 1/2"	Ratchet Handle 1/2"	RH4H
ด้ามเลื่อน	T-type Driver Handle	SL20
บ็อกซ์ด้ามไขควง	Driver Handle	115
ข้อต่อ 1/2"	Extension Bar	321 (150mm.)
ข้ออ่อน 1/2"	Ball Joint	BJ40
ประแจปากตาย	Spanner	DS- 5.507, 0810, 1012, 1113, 1214, 1417, 1921, 2224
ประแจแหวง (ยาว)	Long Offset Wrench	M45- 1012, 1113, 1214, 1417, 1921, 2224
ประแจแหวงข้างปากตาย	Combination Wrench	CS-10, 12, 13, 14, 17, 19, 21
ไขควงด้ามยาง	Power Grip Screwdriver	PGMD- 075, 100, 150 PGPD- 001, 002, 003
ประแจเลื่อน	Adjustable Wrench	MWR- 200, 300
คีมปากขยาย	Combination Slim Pliers	CPS-200G
คีมจับแป๊ป	Water Pump Pliers	SWP-250
คีมหนีบแหวน	Snap Ring Pliers	SRPS-175, SRPH-175
คีมปากจิ้งจก	Lineman's Pliers	CT-175G
คีมปากแหลม	Needle Nose Pliers	RP-150G
คีมปากเฉียง	Diagonal Cutting Pliers	KN-150G
คีมจับท่อ	Aluminium Pipe Wrench	ALPW-300 (300 mm.)
คีมล็อก	Grip Pliers	VP-250
คีมตัด	Mini Cutter	MCH-200
ค้อน 1 ปอนด์	Combination Hammer	BHC-10 (1 lbs.)
ค้อนยางยูริเทน	Shockless Hammer	UH-10 (1 lbs.)
ชุดประแจหกเหลี่ยมหัวบอล	Long Ball Point Hex.Key Wrench Set	BL900 (BL-1.5, 02, 2.5, 03, 04, 05, 06, 08, 10)
ชุดดอกสว่าน 15 ไส้	NGK Drill Bits Set (Jean Bag)	NGK-15J (NGK- 3.0, 3.5, 4.0, 4.5, 5.0, 5.5, 6.0, 6.5, 7.0, 7.5 8.0, 8.5, 9.0, 9.5, 10.0)
แผงแขวนเครื่องมือ	Service Board with Shutter	C635B

# TOOL CABINET SET

## ชุดตู้พร้อมเครื่องมือ 87 ชิ้น



111-62-TCS911(G)



Layer 1



Layer 2



Layer 3

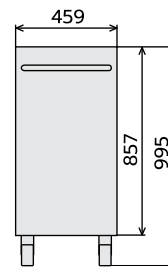
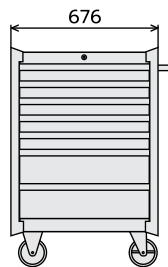

NGK-15J

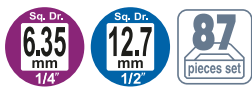

ตู้เครื่องมือสามารถเลือกได้ 3 สี

- สีแดง
- สีเงิน
- สีดำ

Product list		Item No.
ลูกบ็อกซ์ 1/4" (6pt.)	Socket 1/4" (6pt.)	2S- 05, 5.5, 07, 08, 10, 12
ลูกบ็อกซ์ 1/2" (6pt.)	Socket 1/2" (6pt.)	4S- 10, 12
ลูกบ็อกซ์ 1/2" (12pt.)	Socket 1/2" (12pt.)	4D- 13, 14, 17, 19, 21, 22, 24, 27, 30, 32
ด้ามขันพรี 1/2"	Ratchet Handle 1/2"	RH4H
บ็อกซ์ด้ามไขควง	Driver Handle	115
ข้อต่อ 1/2"	Extension Bar 1/2"	321 (150mm.)
ข้ออ่อน 1/2"	Ball Joint 1/2"	BJ40
ประแจปากตาย	Spanner	DS- 5.507, 0810, 1012, 1113, 1214, 1417, 1921, 2224
ประแจแหวน (ยาว)	Long Offset Wrench	M45- 1012, 1113, 1214, 1417, 1921, 2224
ประแจแหวนข้างปากตาย	Combination Wrench	CS- 10, 12, 14, 17, 19, 21
ไขควงด้ามยาง	Power Grip Screwdriver	PGMD- 075, 100, 150 PGPD- 001, 002, 003
ประแจเลื่อน	Adjustable Wrench	MWR- 200, 300
คีมปากขยาย	Combination Slim Pliers	CPS-200G
คีมคอปป์	Water Pump Pliers	SWP-250
คีมหนีบแหวน	Snap Ring Pliers	SRPH-175 SRPS-175
คีมปากจิ้งจก	Lineman's Pliers	CT-175G
คีมปากแหลม	Needle Nose Pliers	RP-150G
คีมปากฉียง	Diagonal Cutting Pliers	KN-150G
ประแจจับเป็นขาคีบ	Aluminum Pipe Wrench	ALPW-300 (300mm.)
คีมล็อก	Grip Pliers	VP-250
คีมตัด	Mini Cutter	MCH-200
ค้อน 1 ปอนด์	Ball Peen Hammer	BH-10
ค้อนยาง	Shockless Hammer	UH-10
ชุดประแจบอลหัวบอลยาว	Long Ball Point Hex. Key Wrench Set	BL900 (BL- 1.5, 02, 2.5, 03, 04, 05, 06, 08, 10)
ชุดดอกสว่าน 15 ไส้	NGK Drill Bits Set (Jean Bag)	NGK-15J (NGK- 3.0, 3.5, 4.0, 4.5, 5.0, 5.5, 6.0, 6.5, 7.0, 7.5, 8.0, 8.5, 9.0, 9.5, 10.0)
ตู้เครื่องมือแบบลิ้นชัก 7 ชั้น	Roller Cabinet	WS207R or WS207S or WS207B

# TOOL CABINET SET

## รถเข็นพร้อมเครื่องมือ 71 ชิ้น

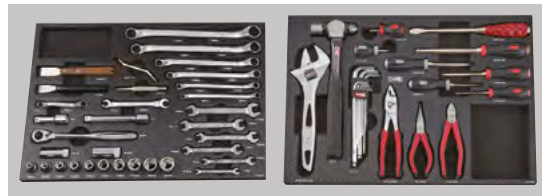

NGK-15J

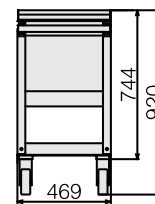
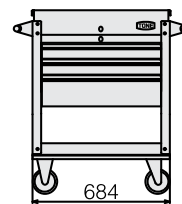
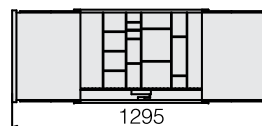

111-66-TCA470(G)



Made in Japan



TOOL SET



Product list		Detail
ลูกบ็อกซ์ 1/2" (6pt.)	Socket 1/2" (6pt.)	4S- 08, 10, 12, 13, 14, 17, 19, 21, 22, 24
ลูกบ็อกซ์ถอดหัวเทียน 1/2"	Plug Socket 1/2"	4P- 16, 20.8
ด้ามขันฟรี 1/2"	Ratchet Handle 1/2"	RH4H
ข้อต่อ 1/2"	Extension Bar 1/2"	320 (75mm.), 321 (150mm.)
ประแจปากตาย	Spanner	DS- 5.507, 0810, 1012, 1113, 1214, 1417
ประแจแวน	Long Offset Wrench	M44- 0810, 1012, 1214, 1417, 1921, 2224
ประแจแวนสั้น	Short Offset Wrench	M46-1012
ประแจแวนผ่า	Flare Nut Wrench	M26-1012
ประแจเลื่อน	Adjustable Wrench	MWR-300
คีมปากขยาย	Combination Slim Pliers	CPS-200G
คีมปากแหลม	Needle Nose Pliers	RP-150G
คีมปากฉีดย	Diagonal Cutting Pliers	KN-150G
ไขควงด้ามยาง	Power Grip Screwdriver	PGMD- 075, 100
		PGPD- 001, 002, 003
ไขควงตัวสั้น	Power Grip Stubby Screwdriver	PGSD-M2
		PGSD-P2
ไขควงแกนทะลุสำหรับงานหนัก	Heavy Duty Screwdriver	PGYMD-150
ค้อน 1 ปอนด์	Ball Peen Hammer	BH-10
เหล็กตั้งเบรค	Brake Shoe Adjusting Tool	BST-110
เหล็กสกัด	Chisel	FC165 (19x165mm.)
เหล็กตอก	Punch	CP125 (125mm.)
เหล็กขูด	Scraper	SSC-22
ชุดประแจบอลหัวอลยาว	Long Ball Point Hex. Key Wrench Set	BL900 (BL-15, 02, 2.5, 03, 04, 05, 06, 08, 10)
ชุดดอกสว่าน 15 ไส้	NGK Drill Bits Set (Jean Bag)	NGK-15J (NGK-3.0, 3.5, 4.0, 4.5, 5.0, 5.5, 6.0, 6.5, 7.0, 7.5, 8.0, 8.5, 9.0, 9.5, 10.0)
ตู้เครื่องมือ	Work Cabin	TC7001R

# TOOL BOX SET

## ชุดกล่องพร้อมเครื่องมือ 86 ชิ้น



111-69-TSX950

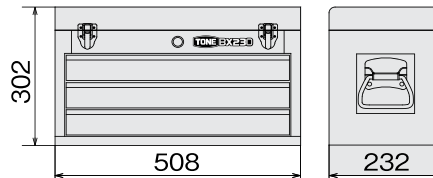

กล่องเครื่องมือสามารถเลือกได้ 3 สี

- สีแดง
- สีเงิน
- สีดำ

TONE Made in Japan

TOOL SET

Product list	Detail	
ลูกบ็อกซ์ 3/8" (6pt.)	Socket 3/8"	3S- 08, 10, 11, 12, 13, 14
ลูกบ็อกซ์ยาว 3/8" (6pt.)	Deep Socket 3/8"	3S- 08L, 10L, 12L, 13L, 14L
ลูกบ็อกซ์ 1/2" (12pt.)	Socket 1/2"	4D- 17, 19, 21, 22, 24, 26, 27, 30, 32, 36
ลูกบ็อกซ์เตี้ยโพลี 1/2" (6pt.)	Hexagon Socket 1/2"	4H- 05, 06, 08, 10, 12, 14, 17
ด้ามขันฟรี 3/8"	Ratchet Handle 3/8"	RH3H
ด้ามขันฟรี 1/2"	Ratchet Handle 1/2"	RH4H
ด้ามบ็อกซ์	Spinner Handle	NS4
ด้ามขันตัวที่ 3/8"	T-type Handle 3/8"	TH3270
ข้อต่อ 3/8"	Extension Bar 3/8"	305 (75 mm.), 306 (150 mm.)
ข้อต่อ 1/2"	Extension Bar 1/2"	320 (75 mm.), 321 (150 mm.), 407 (250 mm.)
ข้ออ่อน 3/8"	Ball Joint 3/8"	BJ30
ข้ออ่อน 1/2"	Ball Joint 1/2"	BJ40
ข้อเพิ่ม	Socket Adaptor	58 (9.5x12.7 mm.)
ข้อลด	Socket Adaptor	68 (12.7x9.5 mm.)
ประแจปากตาย	Spanner	DS- 5.507,0810, 1012, 1113, 1214, 1417
ประแจแหวนคอยาว	Long Offset Wrench	M45- 1012, 1113, 1214, 1417, 1921, 2224
ประแจแหวนตัวสั้น	Short Offset Wrench	M46- 0810, 1012, 1113, 1417
ประแจเลื่อน	Adjustable Wrench	MWR-300
ประแจเลื่อนด้ามสั้น	Short Adjustable Wrench	MWRS-26
คีมปากขยาย	Combination Slim Pliers	CPS-200G
คีมคอปป์	Water Pump Pliers	SWP-250
คีมถอนหมุด	Broken Nut Pliers	BNP-175G
คีมปากจิ้งจก	Lineman's Pliers	CT-175
คีมปากแหลม	Needle Nose Pliers	RP-150G
คีมปากเฉียง	Diagonal Cutting Pliers	KN-150G
ไขควง (ด้ามยาง)	Power Grip Screwdriver	PGMD- 075, 100, 150 PGPD- 001, 002, 003
ไขควงงานหนัก	Heavy Duty Screwdriver	PGYMD-150
ค้อน 1 ปอนด์	Combination Hammer	BHC-10 (1 lbs.)
เหล็กสกัด	Chisel	FC165 (19x165 mm.)
คีมตัด	Mini Cutter	MCH-200
คีมจับท่อ	Aluminium Pipe Wrench	ALPW-300 (300 mm.)
ชุดประแจหกเหลี่ยมหัวบอล	Long Ball Point Hex. Key Wrench Set	BL900 (BL- 1.5, 02, 2.5, 03, 04, 05, 06, 08, 10)
กล่องเครื่องมือลิ้นชัก	Tool Chest	BX230 or BX230SV or BX230BK

# TOOL BOX SET

## ชุดกล่องพร้อมเครื่องมือ 60 ชิ้น

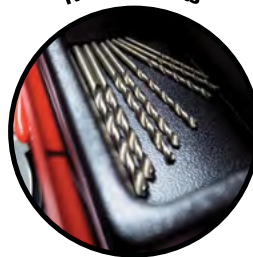

NGK Drill Bits

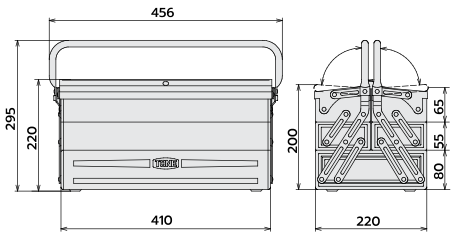

111-80-700SDG

Made in Japan

 Sq. Dr.  
**12.7**  
mm  
1/2"

**60**  
pieces set

TOOL SET

Product list		Detail
ลูกบ็อกซ์ 1/2" (6pt.)	Socket 1/2" (6pt.)	4S- 08, 10, 12, 13, 14
ลูกบ็อกซ์ 1/2" (12pt.)	Socket 1/2" (12pt.)	4D- 17, 19, 21, 22, 24, 26, 27, 30, 32
ด้ามขันพรี 1/2"	Ratchet Handle 1/2"	RH4H
ด้ามบ็อกซ์ (สั้น)	Shot Spinner Handle	NS4S
ข้อต่อ 1/2"	Extension Bar 1/2"	321 (150 mm.)
ชุดประแจปากตาย	Spanner Set	DS602P (DS- 5.507, 0810, 1113, 1214, 1719, 2224)
ประแจแวนคอยาว	Long Offset Wrench	M45- 1012, 1113, 1417, 1921, 2224
ประแจเลื่อน	Adjustable Wrench	MWR-300
คีมปากแหลม	Needle Nose Pliers	RP-150G
คีมปากขยาย	Combination Slim Pliers	CPS-200G
คีมปากจิ้งจก	Lineman's Pliers	CT-175G
คีมค้อน	Water Pump Pliers	KWP-250
คีมปากเฉียง	Diagonal Cutting Pliers	KN-150G
ไขควงด้ามพลาสติก	Screwdriver	KMD- 075, 100, 150 KPD- 001, 002, 003
ค้อน 1 ปอนด์	Combination Hammer	BHC-10 (1 lbs.)
เหล็กสกัด	Chisel	FC165 (19x165 mm.)
เหล็กตอก	Punch	CP125 (125 mm.)
ชุดประแจหกเหลี่ยมหัวบอล	Long Ball Point Hex. Key Wrench Set	BL900 (BL- 1.5, 02, 2.5, 03, 04, 05, 06, 08, 10)
ดอกสว่าน GEKKOU	NGK Drill Bits	NGK- 3.0, 3.2, 3.5, 4.0, 4.2, 4.5, 5.0
กล่องเครื่องมือ	Tool Case	BX430

# BALL POINT HEX KEY WRENCH (L-TYPE)

## ประแจหกเหลี่ยมหัวบอล



### BS SERIES ประแจหกเหลี่ยมหัวบอล (สั้น)

Long Hexagon Wrench

Item No.	S(mm.)	H	L
113-295-BS-1.5	1.5	14	51
113-295-BS-02	2	16	58
113-295-BS-2.5	2.5	18	65
113-295-BS-03	3	20	74
113-295-BS-04	4	25	78
113-295-BS-05	5	28	89
113-295-BS-06	6	32	101
113-295-BS-08	8	36	112
113-295-BS-10	10	40	128



### ชุดประแจหกเหลี่ยมหัวบอล (สั้น)

Short Ball Point Hexagon Wrench Set

Item No.	Contents (mm.)	Q'ty
113-295-BS900	1.5, 2, 2.5, 3, 4, 5, 6, 8, 10	9



### BS-S SERIES ประแจหกเหลี่ยมหัวบอล (ตัว, คอสั้น)

Short Ball Point Hexagon Wrench

Item No.	S(mm.)	H	L
113-295-BS-1.5S	1.5	4	51
113-295-BS-02S	2	5	58
113-295-BS-2.5S	2.5	6	65
113-295-BS-03S	3	8	74
113-295-BS-04S	4	9	78
113-295-BS-05S	5	11	89
113-295-BS-06S	6	13	101
113-295-BS-08S	8	16	112
113-295-BS-10S	10	18	128



### ชุดประแจหกเหลี่ยมหัวบอล (ตัว, คอสั้น)

Short Ball Point Hexagon Wrench Set

Item No.	Contents (mm.)	Q'ty
113-295-BS900S	1.5, 2, 2.5, 3, 4, 5, 6, 8, 10	9



### BSB-S SERIES ประแจหกเหลี่ยมหัวบอล (ตัว, คอสั้น)

Short Ball Point Hexagon Wrench

Item No.	(Inch)	H	L
113-296-BSB-02S	1/16"	4	50
113-296-BSB-2.5S	5/64"	5	56
113-296-BSB-03S	3/32"	6	63
113-296-BSB-04S	1/8"	8	71
113-296-BSB-05S	5/32"	9	80
113-296-BSB-06S	3/16"	11	90
113-296-BSB-07S	7/32"	12	94
113-296-BSB-08S	1/4"	13	100
113-296-BSB-10S	5/16"	16	112
113-296-BSB-12S	3/8"	18	125

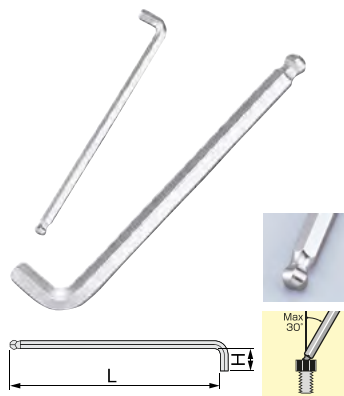

### ชุดประแจหกเหลี่ยมหัวบอล (ตัว, คอสั้น)

Short Ball Point Hexagon Wrench Set

Item No.	Contents (Inch)	Q'ty
113-296-BSB900S	1/16" 5/64" 3/32" 1/8" 5/32" 3/16" 1/4" 5/16" 3/8"	9



### BPL SERIES ประแจหกเหลี่ยมหัวบอล (ยาว)

Long Ball Point Hexagon Wrench

Item No.	S(mm.)	H	L
113-297-BPL-1.5	1.5	15	98
113-297-BPL-02	2	16	103
113-297-BPL-2.5	2.5	19	113
113-297-BPL-03	3	21	122
113-297-BPL-04	4	25	131
113-297-BPL-05	5	30	140
113-297-BPL-06	6	34	154
113-297-BPL-08	8	43	172
113-297-BPL-10	10	52	190



BPL700

BPL900



### ชุดประแจหกเหลี่ยมหัวบอล (ยาว)

Long Ball Point Hexagon Wrench Set

Item No.	Contents (mm.)	Q'ty
113-297-BPL700	2, 2.5, 3, 4, 5, 6, 8	7
113-297-BPL900	1.5, 2, 2.5, 3, 4, 5, 6, 8, 10	9



# LONG BALL POINT HEX KEY WRENCH (L-TYPE)

## ประแจหกเหลี่ยมหัวบอล

**MASTER  
TOOL**

**BL SERIES**  
ประแจหกเหลี่ยมหัวบอล  
(ยาว)  
Long Ball Point Hexagon Wrench

Item No.	S(mm.)	H	L
113-291-BL-1.5	1.5	14	81
113-291-BL-02	2	16	96
113-291-BL-2.5	2.5	18	111
113-291-BL-03	3	20	127
113-291-BL-04	4	25	142
113-291-BL-05	5	28	160
113-291-BL-06	6	32	180
113-291-BL-08	8	36	198
113-291-BL-10	10	40	225

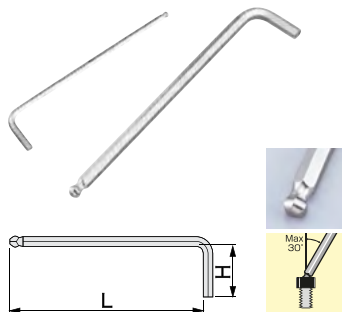
**BL700**

**MASTER  
TOOL**

ชุดประแจหกเหลี่ยมหัวบอล (ยาว)  
Long Ball Point Hexagon Wrench Set

Item No.	Contents (mm.)	Q'ty
113-291-BL700	1.5, 2, 2.5, 3, 4, 5, 6	7
113-291-BL900	1.5, 2, 2.5, 3, 4, 5, 6, 8, 10	9

**BL900**

Made in Japan

**TONE**

 HEX KEY  
WRENCH

**MASTER  
TOOL**

**BLB SERIES**  
ประแจหกเหลี่ยมหัวบอล  
(ยาว)  
Long Ball Point Hexagon Wrench

Item No.	(Inch)	H	L
113-292-BLB-02	1/16"	14	90
113-292-BLB-2.5	5/64"	16	100
113-292-BLB-03	3/32"	18	112
113-292-BLB-04	1/8"	20	126
113-292-BLB-05	5/32"	25	140
113-292-BLB-06	3/16"	28	160
113-292-BLB-07	7/32"	30	170
113-292-BLB-08	1/4"	32	180
113-292-BLB-10	5/16"	36	200
113-292-BLB-12	3/8"	40	224

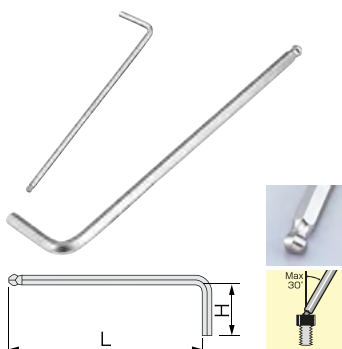
**MASTER  
TOOL**

ชุดประแจหกเหลี่ยมหัวบอล (ยาว)  
Long Ball Point Hexagon Wrench Set

Item No.	Contents (Inch)	Q'ty
113-292-BLB900	1/16" 5/64" 3/32" 1/8" 5/32" 3/16" 1/4" 5/16" 3/8"	9

**MASTER  
TOOL**

**BL-S SERIES**  
ประแจหกเหลี่ยมหัวบอล  
(คอสั้น)  
Short Neck Ball Point Hexagon Wrench

Item No.	S(mm.)	H	L
113-293-BL-1.5S	1.5	4	81
113-293-BL-02S	2	5	96
113-293-BL-2.5S	2.5	6	111
113-293-BL-03S	3	8	127
113-293-BL-04S	4	9	142
113-293-BL-05S	5	11	160
113-293-BL-06S	6	13	180
113-293-BL-08S	8	16	198
113-293-BL-10S	10	18	225

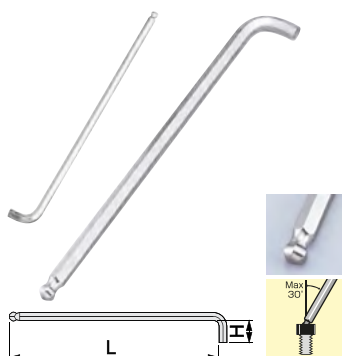
**BL700S**

**MASTER  
TOOL**

ชุดประแจหกเหลี่ยมหัวบอล (คอสั้น)  
Short Neck Ball Point Hexagon Wrench Set

Item No.	Contents (mm.)	Q'ty
113-293-BL700S	1.5, 2, 2.5, 3, 4, 5, 6	7
113-293-BL900S	1.5, 2, 2.5, 3, 4, 5, 6, 8, 10	9

**BL900S**

**MASTER  
TOOL**

**BLB-S SERIES**  
ประแจหกเหลี่ยมหัวบอล  
(คอสั้น)  
Short Neck Ball Point Hexagon Wrench

Item No.	(Inch)	H	L
113-294-BLB-02S	1/16"	4	90
113-294-BLB-2.5S	5/64"	5	100
113-294-BLB-03S	3/32"	6	112
113-294-BLB-04S	1/8"	8	126
113-294-BLB-05S	5/32"	9	140
113-294-BLB-06S	3/16"	11	160
113-294-BLB-07S	7/32"	12	170
113-294-BLB-08S	1/4"	13	180
113-294-BLB-10S	5/16"	16	200
113-294-BLB-12S	3/8"	18	224

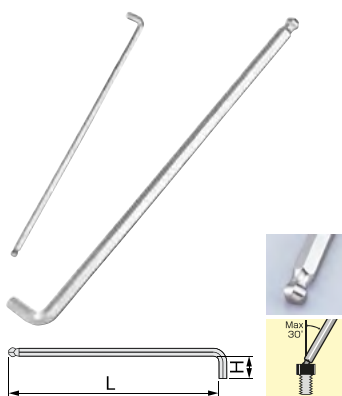
**MASTER  
TOOL**

ชุดประแจหกเหลี่ยมหัวบอล (คอสั้น)  
Short Neck Ball Point Hexagon Wrench Set

Item No.	Contents (Inch)	Q'ty
113-294-BLB900S	1/16" 5/64" 3/32" 1/8" 5/32" 3/16" 1/4" 5/16" 3/8"	9

# SPANNER OFFSET WRENCH

## ประเภทตาย

### DS SERIES ประเภทตาย Spanner



DS-0809

DS-1417

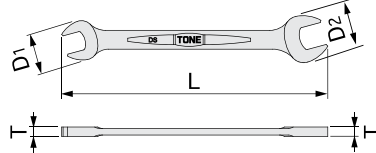

Item No.	Size(mm.)	D1	D2	L	T
115-328-DS-5.507	5.5×7	12	15	104	3.2
115-328-DS-0607	6×7	12	15	104	3.2
115-328-DS-0708	7×8	15	17	111	4
115-328-DS-0809	8×9	17	19	119	4.5
115-328-DS-0810	8×10	17	21	126	4.5
115-328-DS-1012	10×12	21	25	141	5
115-328-DS-1013	10×13	21	27	149	5
115-328-DS-1113	11×13	23	27	149	5.5
115-328-DS-1214	12×14	25	28.5	156	6
115-328-DS-1317	13×17	27	35	179	6.5
115-328-DS-1417	14×17	28.5	35	179	7
115-328-DS-1618	16×18	33	37	186	7.5
115-328-DS-1719	17×19	35	39	194	7.5
115-328-DS-1921	19×21	39	43	209	8
115-328-DS-1922	19×22	39	45	216	8
115-328-DS-2123	21×23	43	47	224	8
115-328-DS-2224	22×24	45	49	231	8.5
115-328-DS-2326	23×26	47	52	246	9
115-328-DS-2427	24×27	49	55.5	254	9.5
115-328-DS-2730	27×30	55.5	60	276	10

**TONE**  
Made in Japan



ชุดประเภทตาย (6 ชิ้น)  
Spanner Set

Item No.	Contents(mm.)	Pcs.
115-327-DS600P	DS- 5.5×07,08×09,10×12, 11×13,12×14,14×17	6



ชุดประเภทตาย (6 ชิ้น)  
Spanner Set

Item No.	Contents(mm.)	Pcs.
115-327-DS601P	DS- 08×09,10×12,12×14, 14×17,19×21,23×26	6

SPANNER OFFSET WRENCH



ชุดประเภทตาย (6 ชิ้น)  
Spanner Set

Item No.	Contents(mm.)	Pcs.
115-327-DS602P	DS- 5.5×07,08×10,11×13, 12×14,17×19,22×24	6



ชุดประเภทตาย (7 ชิ้น)  
Spanner Set

Item No.	Contents(mm.)	Pcs.
115-327-DS700P	DS- 5.5×07,08×10,10×12,11×13, 12×14,14×17,17×19	7

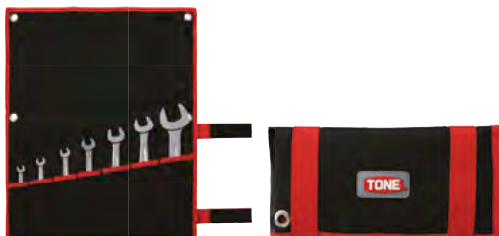

ชุดประเภทตาย (7 ชิ้น)  
Spanner Set

Item No.	Contents(mm.)	Pcs.
115-328-DS700	DS- 5.5×07,08×10,11×13,12×14, 17×19,22×24,27×30	7

# COMBINATION WRENCH

## ประแจแวนข้างปากตาย



### CS SERIES ประแจแวนข้างปากตาย Combination Wrench

Item No.	Size(mm.)	D1	D2	L	T1
115-332-CS-5.5	5.5×5.5	12	9	88	3.2
115-332-CS-06	6×6	12	9	101	3.2
115-332-CS-07	7×7	15	11	113	3.2
115-332-CS-08	8×8	17	12	126	4.5
115-332-CS-09	9×9	19	13.5	138	4.5
115-332-CS-10	10×10	21	14.5	151	5
115-332-CS-11	11×11	23	16.5	164	5.5
115-332-CS-12	12×12	25	17.5	176	6
115-332-CS-13	13×13	27	18.5	189	6.5
115-332-CS-14	14×14	28.5	20	201	7
115-332-CS-15	15×15	31	21.5	214	7
115-332-CS-16	16×16	33	23	227	7
115-332-CS-17	17×17	35	24.5	239	7
115-332-CS-18	18×18	37	26	252	7.5
115-332-CS-19	19×19	39	27	264	7.5
115-332-CS-20	20×20	41	28.5	277	8
115-332-CS-21	21×21	43	30	290	8
115-332-CS-22	22×22	45	31.5	302	8
115-332-CS-23	23×23	47	33	315	8
115-332-CS-24	24×24	49	34	327	8.5

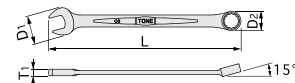
**CS-17**
**CS-19**

Item No.	Size(mm.)	D1	D2	L	T1
115-332-CS-25	25×25	52	36	340	9
115-332-CS-26	26×26	52	36.5	353	9
115-332-CS-27	27×27	55.5	37.5	365	9.5
115-332-CS-28	28×28	57.5	40.5	378	9.5
115-332-CS-29	29×29	60	42	390	10
115-332-CS-30	30×30	60	42	403	10
115-332-CS-32	32×32	65	46	428	11
115-332-CS-33	33×33	67.5	47.5	441	12
115-332-CS-34	34×34	69.5	50	453	12
115-332-CS-35	35×35	72	52	466	13
115-332-CS-36	36×36	73	52	479	13
115-332-CS-38	38×38	77	55	504	15
115-332-CS-41	41×41	84	59	542	15
115-332-CS-46	46×46	94	66	605	17
115-332-CS-50	50×50	98	69.5	655	18



Made in Japan



 COMBINATION  
WRENCH

**ชุดประแจแวนข้างปากตาย (6 ชิ้น)**  
Combination Wrench Set

Item No.	Contents(mm.)	Pcs.
115-331-CS600P	CS- 08, 10, 12, 13, 14, 17	6

**ชุดประแจแวนข้างปากตาย (7 ชิ้น)**  
Combination Wrench Set

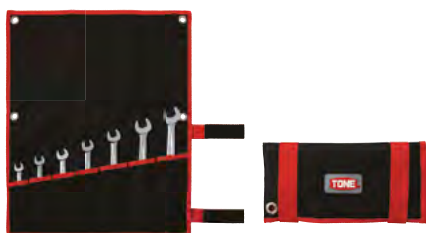
Item No.	Contents(mm.)	Pcs.
115-331-CS700P	CS- 08, 10, 12, 13, 14, 17, 19	7

**ชุดประแจแวนข้างปากตาย (7 ชิ้น)**  
Combination Wrench Set

Item No.	Contents(mm.)	Pcs.
115-331-CS700	CS- 08, 10, 12, 13, 14, 17, 19	7

**ชุดประแจแวนข้างปากตาย (10 ชิ้น)**  
Combination Wrench Set

Item No.	Contents(mm.)	Pcs.
115-330-CS100	CS- 08, 10, 11, 12, 13, 14, 17, 19, 21, 22	10

**ชุดประแจแวนข้างปากตาย**  
Combination Wrench Set

Item No.	Contents(mm.)	Pcs.
115-0-CS107	CS- 06, 08, 10, 12, 14, 15, 17	7
115-0-CS111	CS- 08, 10, 11, 12, 14, 15, 17, 19, 21, 22, 24	11
115-332-CS114	CS- 08, 10, 11, 12, 14, 15, 17, 19, 21, 22, 24, 27, 30, 32	14

# OFFSET WRENCH LONG TYPE (45°)

## ประเภทออฟเซตยาว



**M45 SERIES**
**ประเภทออฟเซตยาว**

## Offset Wrench Long Type

Item No.	Size(mm.)	D1	D2	L	T1
115-335-M45-5.507	5.5×7	10	11.5	151	5
115-335-M45-0809	8×9	13	14.5	182	6
115-335-M45-0810	8×10	13	15.5	184	6
115-335-M45-1012	10×12	15.5	18	194	6.5
115-335-M45-1013	10×13	15.5	19	196	6.5
115-335-M45-1113	11×13	16.5	19	198	7
115-335-M45-1214	12×14	18	21	220	7.5
115-335-M45-1317	13×17	19	25.5	247	8
115-335-M45-1415	14×15	21	23	247	8.5
115-335-M45-1417	14×17	21	25.5	248	8.5
115-335-M45-1618	16×18	24.5	27	270	9.5
115-335-M45-1719	17×19	25.5	28	280	9.5
115-335-M45-1721	17×21	25.5	30	298	9.5
115-335-M45-1921	19×21	28	30	307	10.5
115-335-M45-1922	19×22	28	32	307	10.5
115-335-M45-1924	19×24	28	35	324	10.5
115-335-M45-2123	21×23	30	33	320	11.5
115-335-M45-2126	21×26	30	36.5	340	11.5
115-335-M45-2224	22×24	32	35	324	12
115-335-M45-2326	23×26	33	36.5	348	13
115-335-M45-2427	24×27	35	37.5	350	13.5
115-335-M45-2430	24×30	35	43	389	13.5

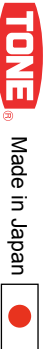

Item No.	Size(mm.)	D1	D2	L	T1
115-335-M45-2629	26×29	36.5	42	384	14
115-335-M45-2632	26×32	37.5	47	398	14
115-335-M45-2730	27×30	37.5	43	391	16.5
115-335-M45-2732	27×32	39	47	413	16.5
115-335-M45-2932	29×32	42	47	415	18.5
115-335-M45-3032	30×32	43	47	420	18.5
115-335-M45-3235	32×35	47	52	430	19
115-335-M45-3236	32×36	47	53	430	19
115-335-M45-3541	35×41	52	60	456	20

**ชุดประแจออฟเซตยาว (6 ชิ้น)**

## Offset Wrench Set, Long Type

Item No.	Contents(mm.)	Pcs.
115-334-2600M	M45- 1012,1214,1417,1719,1921,2326	6

**ชุดประแจออฟเซตยาว (6 ชิ้น)**

## Offset Wrench Set, Long Type

Item No.	Contents(mm.)	Pcs.
115-334-2700M	M45- 0810,1113,1214,1417,1922,2427	6

**ชุดประแจออฟเซตยาว (8 ชิ้น)**

## Offset Wrench Set, Long Type

Item No.	Contents(mm.)	Pcs.
115-334-2800M	M45-0809, 1012,1113,1417 1921, 2224,2326,2427	8



Item No.	Size(mm.)	D1	D2	L	T1
115-337-M46-5.507	5.5×7	10	11.5	104	5
115-337-M46-0809	8×9	13	14.5	105	5.5
115-337-M46-0810	8×10	13	15.5	108	5.5
115-337-M46-1012	10×12	15.5	18	115	6.5
115-337-M46-1113	11×13	16.5	19	115	7
115-337-M46-1214	12×14	18	21	130	7.5
115-337-M46-1417	14×17	21	25.5	147	8.5
115-337-M46-1921	19×21	28	30	175	10.5

**M46 SERIES**
**ประเภทออฟเซตสั้น**

## Offset Wrench, Short Type

**ชุดประแจออฟเซตสั้น (5 ชิ้น)**

## Offset Wrench Set, Short Type

Item No.	Contents(mm.)	Pcs.
115-337-M465	M46- 0809,1012,1113,1214,1417	5



# SOCKET WRENCH SET

## ชุดลูกบ็อกซ์พร้อมด้ามขันฟรี

Made in Japan



Sq. Dr. 12.7 mm 1/2" mm 17 pieces set

**112-179-760M**  
ชุดลูกบ็อกซ์พร้อมด้ามขันฟรี 4 ชุด  
Socket Wrench Set

อุปกรณ์ในชุด		Item No.
ลูกบ็อกซ์ 1/2"	Socket	4D-10,12,13,14,17,19,21,22,24,26,27,30,32
ด้ามขันฟรี 1/2"	Ratchet Handle	RH4H
ด้ามบ็อกซ์	Short Spinner Handle	NS4S
ข้อต่อ	Extension Bar	321 (150mm.)
ข้ออ่อน	Ball joint	BJ40
กล่องโลหะ	Metal Case	MCT2



Sq. Dr. 12.7 mm 1/2" mm 17 pieces set

**112-179-760MS**  
ชุดลูกบ็อกซ์พร้อมด้ามขันฟรี 4 ชุด  
Socket Wrench Set

อุปกรณ์ในชุด		Item No.
ลูกบ็อกซ์ 1/2"	Socket	4S-10,12,13,14,17,19,21,22,24,26,27,30,32
ด้ามขันฟรี 1/2"	Ratchet Handle	RH4H
ด้ามบ็อกซ์	Short Spinner Handle	NS4S
ข้อต่อ	Extension Bar	321 (150mm.)
ข้ออ่อน	Ball joint	BJ40
กล่องโลหะ	Metal Case	MCT2



Sq. Dr. 12.7 mm 1/2" mm 17 pieces set

**112-180-750MS**  
ชุดลูกบ็อกซ์พร้อมด้ามขันฟรี 4 ชุด  
Socket Wrench Set

อุปกรณ์ในชุด		Item No.
ลูกบ็อกซ์ 1/2"	Socket	4S-08,10,11,12,13,14,17,19,21,22,24,26,27
ด้ามขันฟรี 1/2"	Ratchet Handle	RH4H
ด้ามบ็อกซ์	Short Spinner Handle	NS4S
ข้อต่อ	Extension Bar	321 (150mm.)
ข้ออ่อน	Ball joint	BJ40
กล่องโลหะ	Metal Case	MCT2



Sq. Dr. 12.7 mm 1/2" mm 19 pieces set

**112-181-260M**  
ชุดลูกบ็อกซ์พร้อมด้ามขันฟรี 4 ชุด  
Socket Wrench Set

อุปกรณ์ในชุด		Item No.
ลูกบ็อกซ์ 1/2"	Socket	4D-09,10,12,13,14,15,16,17,18,19,21,23,26,29,32
ด้ามขันฟรี 1/2"	Ratchet Handle	RH4H
ด้ามบ็อกซ์	Spinner Handle	NS4
ด้ามเลื่อนตัวที	T-Type Slide Handle	SL40
ข้อต่อ	Extension Bar	321 (150mm.)
กล่องโลหะ	Metal Case	MCT3



Sq. Dr. 12.7 mm 1/2" mm 19 pieces set

**112-181-260M ISO**  
ชุดลูกบ็อกซ์พร้อมด้ามขันฟรี 4 ชุด  
Socket Wrench Set

อุปกรณ์ในชุด		Item No.
ลูกบ็อกซ์ 1/2"	Socket	4D-08,10,11,12,13,14,17,19,21,22,24,26,27,30,32
ด้ามขันฟรี 1/2"	Ratchet Handle	RH4H
ด้ามบ็อกซ์	Spinner Handle	NS4
ด้ามเลื่อนตัวที	T-Type Slide Handle	SL40
ข้อต่อ	Extension Bar	321 (150mm.)
กล่องโลหะ	Metal Case	MCT3



Sq. Dr. 12.7 mm 1/2" mm 25 pieces set

**112-182-160M**  
ชุดลูกบ็อกซ์พร้อมด้ามขันฟรี 4 ชุด  
Socket Wrench Set

อุปกรณ์ในชุด		Item No.
ลูกบ็อกซ์ 1/2"	Socket	4D-08,09,10,11,12,13,14,17,19,21,22,23,24,26,27,29,30,32
ด้ามขันฟรี 1/2"	Ratchet Handle	RH4H
ด้ามบ็อกซ์	Spinner Handle	NS4
ด้ามเลื่อนตัวที	T-Type Slide Handle	SL40
ข้อต่อ	Extension Bar	320 (75mm.), 321 (150mm.), 470 (250mm)
ข้ออ่อน	Universal Joint	UJ40
กล่องโลหะ	Metal Case	MCT3

# TORQUE WRENCH

## ประเภท

### TMN SERIES ประเภท

Torque Wrench, Preset Type (Digital Reading)

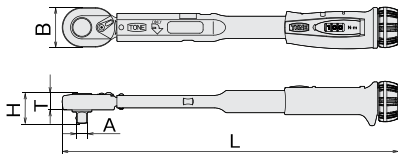

Item No.	A (mm.)	Range (Min~Max) [N.m]	B	H	T	L	Increments [N.m]
118-475-T2MN6	6.35	1~6	24	18.3	10.4	222	0.1
118-475-T2MN10	6.35	2~10	24	18.3	10.4	253	0.2
118-475-T2MN13	6.35	3~13	24	18.3	10.4	253	0.2
118-475-T2MN15	6.35	3~15	24	18.3	10.4	253	0.2
118-475-T3MN20	9.5	4~20	24	21.5	10.4	253	0.2
118-475-T3MN25	9.5	5~25	24	21.5	10.4	253	0.2
118-475-T3MN50	9.5	10~50	36	26.4	14	308	0.5
118-475-T4MN50	12.7	10~50	36	30.4	14	308	0.5
118-475-T3MN100	9.5	20~100	36	26.4	14	387	1
118-475-T4MN100	12.7	20~100	36	30.4	14	387	1
118-475-T4MN140	12.7	30~140	36	30.4	14	450	1
118-475-T4MN200	12.7	40~200	45.2	34	17.8	526	2
118-475-T4MN300	12.7	40~300	45.2	34	17.8	716	2
118-475-T6MN300	19.0	40~300	45.2	41.5	17.8	716	2



### TM SERIES ประเภท

Torque Wrench, Preset Type (Digital Reading)

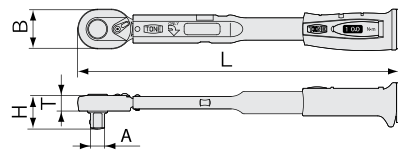

Item No.	A (mm.)	Range (Min~Max) [N.m]	B	H	T	L	Increments [N.m]
118-486-T2M6	6.35	1~6	24	18.3	10.4	211	0.1
118-486-T2M13	6.35	3~13	24	18.3	10.4	240	0.2
118-486-T3M20	9.5	4~20	24	21.6	10.4	240	0.2
118-486-T3M50	9.5	10~50	36	26.4	14	291	0.5
118-486-T4M50	12.7	10~50	36	30.4	14	291	0.5
118-486-T3M100	9.5	20~100	36	26.4	14	369	1
118-486-T4M100	12.7	20~100	36	30.4	14	369	1
118-486-T4M140	12.7	30~140	36	30.4	14	432	1
118-486-T4M200	12.7	40~200	45.2	34	17.8	505	2
118-486-T6M300	19	40~300	45.2	40.5	17.8	696	2

TORQUE WRENCH

### TLN SERIES ประเภท

Torque Wrench, Preset Type

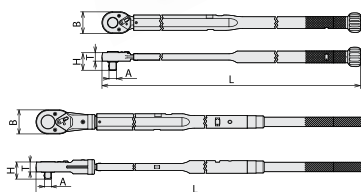

Item No.	A (mm.)	Range (Min~Max) [N.m]	B	H	T	L	Increments [N.m]
118-483-T6L420N	19.0	60~420	54	42.7	21	965	2
118-483-T6L700N	19.0	100~700	68	49.5	27.5	1314	5
118-483-T8L850N	25.4	100~850	76	58	29	1388	5
118-483-T8L1000N	25.4	100~1,000	76	58	29	1538	5
118-483-T8L1500N	25.4	200~1,500	87	61	32.5	1844	10
118-483-T8L2100N	25.4	700~2,100	87	61	34	1844	10

# TORQUE WRENCH (ADJUSTABLE WRENCH TYPE)

## ประแจปอนด์ปากเลื่อน

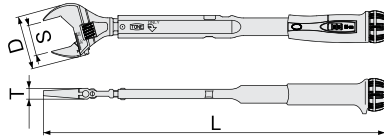

### TMWM SERIES ประแจปอนด์ปากเลื่อน

Torque Wrench, Adjustable Wrench Type (Digital Reading)

Item No.	Range (Min-Max) [N.m]	S (mm)	D	T	L	Increments [N.m]
118-492-TMWM15	3~15	10~27	49.3	9.9	289	0.2
118-492-TMWM25	5~25	10~27	49.3	9.9	330	0.2
118-492-TMWM25W	5~25	17~38	66.8	13.3	346	0.2
118-492-TMWM50	10~50	10~27	49.3	9.9	330	0.5
118-492-TMWM50W	10~50	17~38	66.8	13.3	346	0.5
118-492-TMWM60	15~60	10~27	49.3	9.9	330	0.5
118-492-TMWM100	20~100	17~38	66.8	13.3	420	1
118-492-TMWM100W	20~100	27~48	83.3	16	438	1
118-492-TMWM115	25~115	17~38	66.8	13.3	420	1
118-492-TMWM150	50~150	17~38	66.8	13.3	483	1
118-492-TMWM150W	50~150	27~48	83.3	16	500	1
118-492-TMWM200	40~200	27~48	83.3	16	570	2

Made in Japan

TORQUE WRENCH

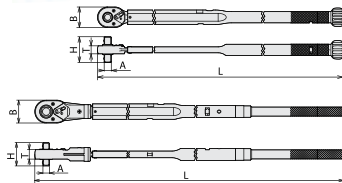
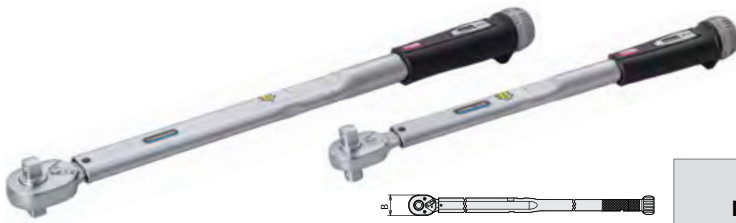

### TMNR SERIES ประแจปอนด์สองทาง

Torque Wrench, Preset Type for Both (Digital Reading)

Item No.	A (mm.)	Range (Min-Max) [N.m]	B	H	T	L	Increments [N.m]
118-484-T4MN100R	12.7	20~100	36	49.2	14	387	1
118-484-T4MN140R	12.7	30~140	36	49.2	14	450	1
118-484-T4MN200R	12.7	40~200	45.2	52.7	20.5	526	2
118-484-T6MN300R	19.0	40~300	45.2	65.2	20.5	716	2

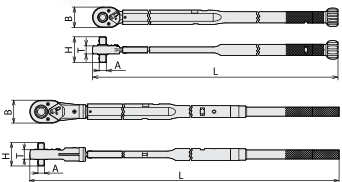

### TLNR SERIES ประแจปอนด์สองทาง

Torque Wrench, Preset Type for Both

Item No.	A (mm.)	Range (Min-Max) [N.m]	B	H	T	L	Increments [N.m]
118-485-T6L420NR	19.0	60~420	54	69.2	21	965	2
118-485-T6L700NR	19.0	100~700	68	69.5	27.5	1314	5
118-485-T6L850NR	19.0	100~850	76	75	29	1388	5
118-485-T8L850NR	25.4	100~850	76	85	29	1388	5

### TD SERIES ประแจปอนด์เปลี่ยนหัว

Torque Wrench, Interchangeable Head

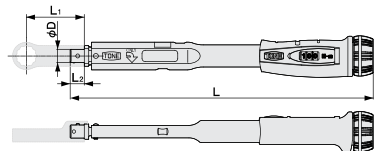

Item No.	ØD (mm.)	Range (Min-Max) [N.m]	L1	T	L	Increments [N.m]
118-481-T8D6	8	1~6	35	9	204	0.1
118-481-T8D13	8	3~13	35	9	233	0.2
118-481-T10D20	10	4~20	44	11	236	0.2
118-481-T12D50	12	10~50	53	13	277	0.5
118-481-T15D100	15	20~100	63	16	356	1
118-481-T15D140	15	30~140	63	16	419	1
118-481-T19D200	19	40~200	80	20	492	2
118-481-T22D300	22	40~300	100	23	684	2

# TORQUE WRENCH DIGITAL

## ชุดไขควงทอร์ก



**TDT SERIES**  
ประเภทปอนด์ดิจิทัล  
Torque Wrench Digital

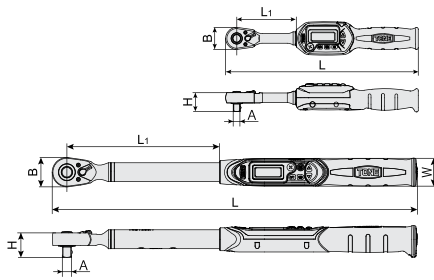

Item No.	A (mm.)	Range (Min-Max) [N.m]	B	H	L	L1	Increments [N.m]
118-469-T2DT30H	6.35	6~30	22.5	19.5	221	38	0.01
118-469-T3DT60H	9.5	12~60	31	26.5	229	42	0.01
118-469-T3DT85H	9.5	17~85	31	26.5	271	84	0.1
118-469-T3DT135H	9.5	27~135	31	26.5	380	193	0.1
118-469-T4DT135H	12.7	27~135	31	30.5	380	193	0.1
118-469-T4DT200H	12.7	40~200	41	34.5	520	216	0.1
118-469-T4DT340H	12.7	68~340	41	34.5	640	336	0.1
118-469-T6DT500H	19.0	100~500	60	55	945	634	0.1
118-469-T6DT850H	19.0	170~850	60	55	1220	910	0.1



**HDT SERIES**  
เครื่องวัดแรงบิดดิจิทัล  
(สำหรับด้านขั้ว)  
Digitortorqon

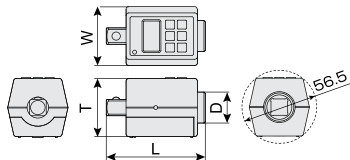

Item No.	dr. (mm.)	Range (Min-Max) [N.m]	W	T	D	L
118-470-H3DT135	9.5	10~135	45	45	24	75
118-470-H4DT200	12.7	200~200	45	45	24	75
118-470-H6DT600	19.0	120~600	90	90	50	99

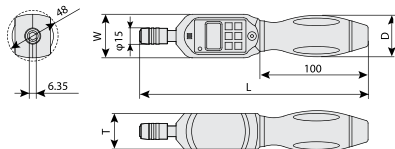

**DBDT SERIES**  
ชุดไขควงทอร์กดิจิทัล  
Screwdriver Digtortorque Set

Item No.	dr. (mm.)	Range (Min-Max) [N.m]	W	T	D	L
118-471-DBDT3S	6.35	30~300	40	32	38.5	212
118-471-DBDT6S	6.35	60~600	40	32	38.5	212

### แสดงพลบนหน้าจอ LED

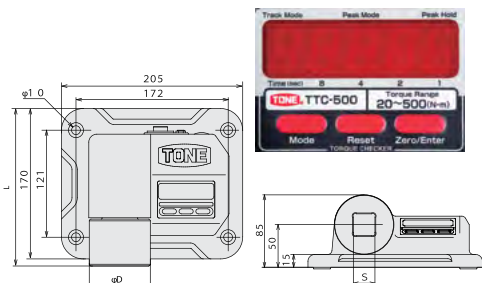

**TTC SERIES**  
เครื่องวัดทอร์กดิจิทัล  
Torque Wrench Testing Machine

Item No.	S (mm.)	Range (Min-Max) [N.m]	D	L	Accuracy
118-493-TTC-60	12.7	2~60	30	155	±1% + 1 increment
118-493-TTC-500	25.4	20~500	48	173	±1% + 1 increment
118-493-TTC-1000	25.4	50~1000	48	173	±1% + 1 increment

# SCREWDRIVER

## ไขควง



Made in Japan



SCREWDRIVER



PGMD-075, 100, 150

PGPD-001, 002, 003

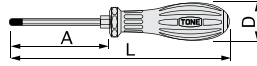
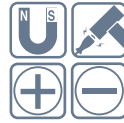

**PGMD, PGPD SERIES**  
ไขควงด้ามยาง (ตอกทะลุ)  
Power Grip Screwdriver (Through Type)

Item No.	Head Type	Size (mm)	A	D	L
117-357-PGMD-075	หัวแบน	-0.8 × 5.5	75	31	167
117-357-PGMD-100	หัวแบน	-1.0 × 6.0	100	34	198
117-357-PGMD-150	หัวแบน	-1.2 × 8.0	150	36	258
117-357-PGMD-001	หัวดอก	+No.1	75	31	167
117-357-PGMD-002	หัวดอก	+No.2	100	34	198
117-357-PGMD-003	หัวดอก	+No.3	150	36	258

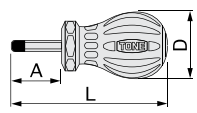

PGSD-M2

PGSD-P2



**PGSD SERIES**

 ไขควงด้ามยางสั้น  
Power Grip Stubby Screwdriver

Item No.	Head Type	Size (mm)	A	D	L
117-357-PGSD-M2	หัวแบน	-0.8 × 6.0	25	34	82
117-357-PGSD-P2	หัวดอก	+No.2	25	34	82

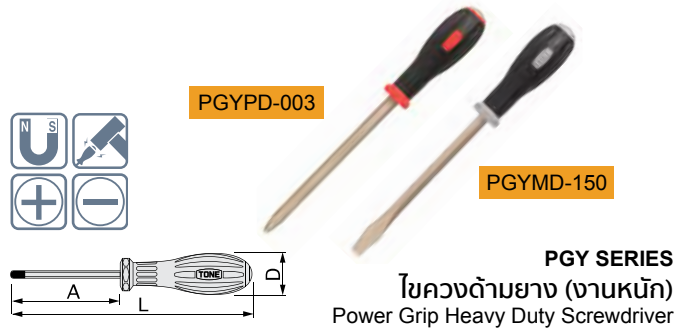

**ชุดไขควงด้ามยาง**  
Power Grip Screwdriver Set

Item No.	Head Type	Contents
117-356-PGD8	หัวแบน หัวดอก	PGMD-075, PGMD-100, PGMD-150, PGSD-M2 PGPD-001, PGPD-002, PGPD-003, PGSD-P2

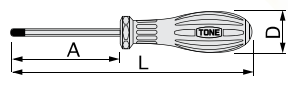

PGYPD-003

PGYMD-150

**PGY SERIES**

 ไขควงด้ามยาง (งานหนัก)  
Power Grip Heavy Duty Screwdriver

Item No.	Head Type	Size (mm)	A	D	L
117-358-PGYMD-150	หัวแบน	-1.2 × 10	167	36	275
117-358-PGYPD-003	หัวดอก	+No.3	167	36	275

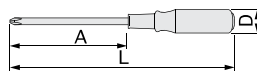
**MD, PD SERIES**  
ไขควงด้ามไม้ (แกนทะลุหัวตอก)  
Screwdriver (Through Type)

Item No.	Head Type	Size (mm)	A	D	L
117-365-MD-050	หัวแบน	-0.6 × 4.5	50	23.5	145
117-365-MD-075	หัวแบน	-0.7 × 5.5	75	23.5	170
117-365-MD-100	หัวแบน	-0.9 × 6.0	100	28.0	218
117-365-MD-125	หัวแบน	-0.9 × 7.0	125	32.5	257
117-365-MD-150	หัวแบน	-1.0 × 8.0	150	32.5	282
117-365-MD-200	หัวแบน	-1.1 × 9.0	200	34.0	348
117-365-PD-001	หัวดอก	+No.1	75	23.5	170
117-365-PD-002	หัวดอก	+No.2	100	28.0	218
117-365-PD-003	หัวดอก	+No.3	150	32.5	282



CDS2

CD-12



**ไขควงด้ามสลับ (สลับ/ยาว)**  
Screwdriver (Reversible Type)

Item No.	Contents
117-365-CDS2	-0.8 × 6.0 / +No.2
117-365-CD-12	-0.6 × 4.5 / +No.1, -0.8 × 6.0 / +No.2

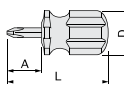

SD-M

SD-P

**SD SERIES**  
ไขควงด้ามสั้น  
Stubby Screwdriver

Item No.	Size (mm)	A	D	L
117-363-SD-M	-0.8 × 7.2	23	31	70
117-363-SD-P	+No.2	23	31	70

# OTHER อื่นๆ

### VP SERIES คีมลีดอก Grip Pliers



Item No.	Max Open (mm)	Cutting Dia (mm)	T	L
116-396-VP-125	25	1.2	40	143
116-396-VP-175	35	2.3	53	193
116-396-VP-250	40	2.3	67	227

### VPL SERIES คีมลีดอกปากยาว Grip Pliers (Long Nose Type)



Item No.	Max Open (mm)	Cutting Dia (mm)	T	L
116-396-VPL-150	50	1.2	42	167
116-396-VPL-250	70	2.3	55	220

### VPS SERIES คีมลีดอกปากตรง Grip Pliers



Item No.	Max Open (mm)	T	L
116-396-VPS-175	25	56	183
116-396-VPS-250	40	66	231

### MWR SERIES ประแจเลื่อน Adjustable Wrench

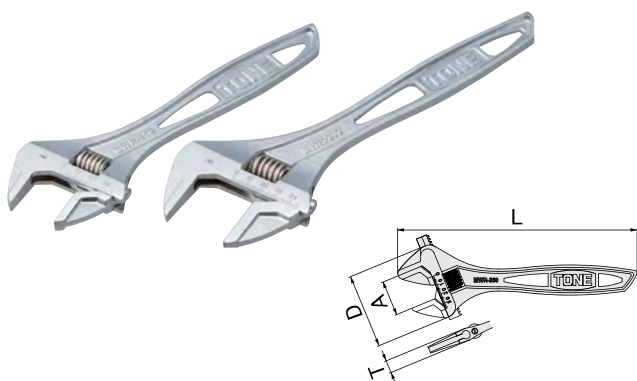

Item No.	Min-Max (mm)	D	A	T	L	Inch
116-390-MWR-100	0~14	32.5	14	8.5	100	4"
116-390-MWR-150	0~26	56	26	10.7	150	6"
116-390-MWR-200	0~30	62	30	13.2	200	8"
116-390-MWR-250	0~36	77	36	14.2	250	10"
116-390-MWR-300	0~46	98	46	16.5	300	12"
116-390-MWR-375	0~46	110	46	23	375	15"
116-390-MWR-450	0~55	129	55	24	450	18"

### MWRS SERIES ประแจเลื่อนด้ามสั้น Adjustable Wrench Short Type

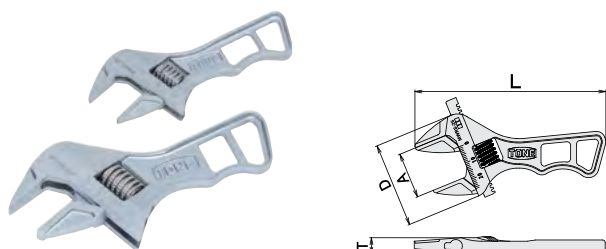

Item No.	Min-Max (mm)	D	A	T	L	Inch
116-391-MWRS-26	0~26	49	26	11.2	110	4"
116-391-MWRS-36	0~36	70	36	14.2	140	6"

TONE Made in Japan

OTHERS

# OTHER อื่นๆ



Made in Japan



OTHERS

## BH SERIES ค้อนหัวเหล็ก

Ball Peen Hammer / Nail Hammer



Item No.	Head Type	A	D	T
117-456-BH-05	0.5 lbs.	82	23	290
117-456-BH-10	1.0 lbs.	104	30	325
117-456-BH-15	1.5 lbs.	118	35	375
117-456-BH-20	2.0 lbs.	130	38	375
117-456-BH-05B	0.5 lbs.	103	22	300

## BHC SERIES

 ค้อนรวม (หัวเหล็ก+หัวยาง)  
Combination Hammer

Item No.	Standard	A	D	T
117-456-BHC-05	0.5 lbs.	72	26	290
117-456-BHC-10	1.0 lbs.	87	32	300
117-456-BHC-15	1.5 lbs.	100	38	330
117-456-BHC-05H	Head (Urethane) for BHC-05			
117-456-BHC-10H	Head (Urethane) for BHC-10			
117-456-BHC-15H	Head (Urethane) for BHC-15			

## ค้อนยาง (ต้านแรงสะท้อน)

Urethane Shockless Hammer

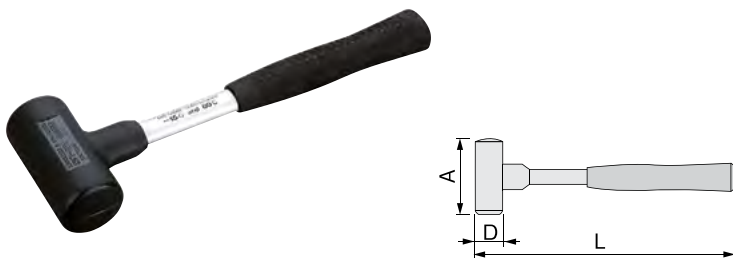

Item No.	Standard	A	D	T
117-456-UH-10	1.0 lbs.	100	49	330

# OTHER อื่นๆ



ตู้รถเข็น 7 ลิ้นชักแบบล้อเลื่อน  
Roller Cabinet

Item No.	Dimension (mm.)	Weight (kg.)
111-102-WS207R	676 x 459 x 995	63.5
111-102-WS207S	676 x 459 x 995	63.5
111-102-WS207B	676 x 459 x 995	63.5



แผงเครื่องมือ  
Service Board with Shutter

Item No.	Dimension (mm.)	Weight (kg.)
111-121-C60B	1,100 x 860 x 165	14.5



กล่องเครื่องมือแบบลิ้นชัก  
Tool Case (Chest)

Item No.	Dimension (mm.)	Weight (kg.)
111-112-BX-230	508 x 232 x 302	9.2
111-112-BX-230SV	508 x 232 x 302	9.2
111-112-BX-230BK	508 x 232 x 302	9.2



กล่องเครื่องมือโลหะ  
Tool Case (Metal)

Item No.	Dimension (mm.)	Weight (kg.)
111-113-BX-331	468 x 240 x 271	6.4
111-113-BX-322	480 x 245 x 225	4.9



กล่องเครื่องมือ  
Tool Case (Metal)

Item No.	Dimension (mm.)	Weight (kg.)
111-114-BX-420	460 x 240 x 230	4.0
111-114-BX-430	460 x 240 x 230	4.2



กล่องเครื่องมือ  
Tool Case (Metal)

Item No.	Dimension (mm.)	Weight (kg.)
111-115-BX-120	422 x 217 x 191	3.6
111-115-BX-510	370 x 190 x 155	1.1



**บริษัท นานตีอินเตอร์เทรด จำกัด**  
**NANDEE INTER-TRADE CO., LTD.**

314,316,318,320,322 ซอยจันทน์ 32 ถนนจันทน์ แขวงทุ่งวัดดอน เขตสาทร กทม. 10120

-  : 0-2675-8239
-  : @nandeeintertrade
-  : nandeeintertrade
-  : [www.nandee.co.th](http://www.nandee.co.th)
-  : [marketing@nandee.co.th](mailto:marketing@nandee.co.th)  
[sales@nandee.co.th](mailto:sales@nandee.co.th)