

delvo

General Catalog



delvo contributes to improvement of assembly quality.



"delvo", a screwdriver that realizes high precision torque management

Products with high reliability are born only with reliable tools.

High Precision

A high precision torque is a must to improve assembly quality. "delvo" has high repeatable torque accuracy, and it is possible to equalize the tightening torque.

Long Life

"delvo" with brush motor uses a long life motor that withstands a guaranteed fastening cycle of a million times. "delvo" with brushless motor are eco-friendly and maintenance free that realize high durability.

Shockless

Original clutch and motor stop mechanism minimizes the shock at the end of the screw fastening. It reduces the fatigue of screw fastening.



Green Procurement

Nitto Kohki has made every effort in environmental improvement schemes on a company-wide basis through the implementation of ISO14001 to execute environmentally conscious business activities. As a part of our ongoing commitment to improve the environment, we are also committed to exclude or reduce restricted chemical substances in our products, as designated by the RoHS directives and Laws and Regulations of Chemical Substances in Japan. For further details, please see the following:

Nitto Kohki group companies' Green Procurement Guidelines have been established by their environmental committee which consists of members from all the Nitto Kohki group of companies. Nitto Kohki group companies give preferential treatment to suppliers that work to an environmental policy framework. Nitto Kohki group companies periodically survey their suppliers to ensure their chemical management systems include the monitoring of environmental issues such as the RoHS directives, and Japanese laws and regulations of Chemical Substances to minimize packaging and waste. We are continuing our goal to ensure that our made-to-order items are also covered by our environmental policy.



Green Procurement Policy

Each of the Nitto Kohki group companies is clarifying the control categories of the environmental management substances included in the parts and auxiliary materials constituting Nitto Kohki products and those of the environmental management substances used in the manufacturing processes. We will promote prohibition and reduction of use of the environmental management substances according to such control categories.

Through these activities, we will comply with various laws and regulations related to the environmental management substances and reduce the impact to the global environmental conservation and to the ecological system.

Scope of Application

Our Green Procurement Guideline applies to all materials, parts, products, and auxiliary materials which Nitto Kohki Group companies purchase for production or sales.

Our Green Procurement Activities

Nitto Kohki group companies continually aim to comply with RoHS directives, and Japanese laws and regulations of Chemical Substances.

- Standard products have been RoHS compliant. Green procurement activities on made-to-order products are continuing.
- Nitto Kohki group companies are now working to the REACH Regulation.
- Nitto Kohki group companies are building a database of the chemical management substances regulated by the RoHS directives, the REACH Regulation and Japanese laws and regulations of Chemical Substances.

- Power type** — The type of power source is indicated.
- Brush motor** **Brushless motor** — The type of motor is indicated.
- Miniature screw** **Precision screw** **Machine screw** — The type of screw* is indicated.
- Screw Size** — The size range of screw is indicated.

* Miniature screw ... for 1.0 to 2.6 mm
 Precision screw ... for 1.0 to 3.5 mm
 Machine screw ... for 2.6 to 8.0 mm

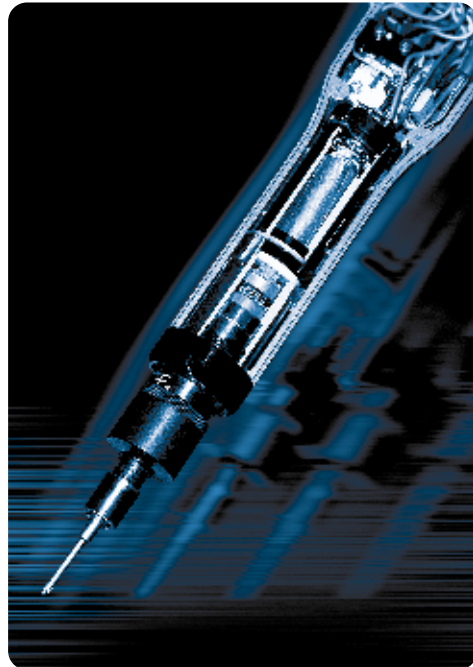

About Torque Management

The fastening torque generated on the screw varies depending on the screw size, material and the type of workpiece. Always check and manage the torque generated on the screw with a torque wrench, etc. The fastening torque varies depending on the fastening conditions.

Both For both hand-held / automated machines
Auto For automated machines

CONTENTS

List of Screwdrivers	3
Selection Chart	8
Both C Series (Current control type)	9
S Series (Variable speed type)	18
A Series (Low voltage, ESD type [DC])	22
A Series (Low voltage, Non-ESD type [DC])	23
A Series (Transformerless type [AC])	25
A Series (Transformerless, Signal output type [AC])	25
DLV02/DLV12/DLV16 Series	27
DLV7400A Series	28
DLV5700 Series Non-CE	29
DLV5800U Series / DLV5800 Series Non-CE	30
DLV7300 Series	31
DLV7300-BME/DLV7300-BKE Series	32
DLV7500/DLV8500 Series	33
DLV7000/DLV8000 Series Non-CE	34
DLV7104/DLV8104/DLV8204 Series Non-CE	35
Screw Fastening Counters Non-CE	37
Auto A Series (For automation) Non-CE	43
Auto DLV3100/DLV3300 Series (For automation) Non-CE	45
Accessories	46
External Dimensions	53
Safety guide	65
How to select a suitable model	66







Quick Reference Symbols

Current Control Type Since the torque is determined by the current value, multiple torque settings are possible.	Clutch Type The torque is determined mechanically.	LED Equipped Shows the channel in use and working status with seven color indication LED.
Lever Start Operates when the lever is pressed.	Push to Start Operates when the screwdriver is pressed.	Transformerless A dedicated controller is not required. Operates by commercial power supply.
Brushless Motor Maintenance free, no brush replacement required. Realizes high durability.	Grounded Bit Prevents electrostatic breakdown when the bit contacts the workpiece.	Low Voltage Connect to dedicated controller. Operates at electric voltage under 42 V.
Clean room adaption Adapts to assembly in class 5 clean rooms	Soft Stop Gradually reduces the rotation speed to improve the screw tightening quality.	ESD Protection Prevents electrostatic charging and saves the workpiece from electrostatic breakdown.
		Low Shock Softens the shock at the end of tightening and lowers the load to the workpiece.
		Soft Start Gradually increases the rotation speed to prevent damage to the screw head.

[Brushless Motor - DC Power Supply]

Page	Outer Appearance	Series	Model	Torque Range (Nm [lbf.in])	Screw Size (mm)		Mass (g [lbs])	Lever Start	Push to Start	ESD Protection	Soft Start	Soft Stop	Low Speed	Medium Speed	High Speed	Built-in Screw Counter	Controller					
					min.	max.											Model	Outer Appearance				
9		C Series (Current control type)	DLV45C12L-AY	0.6 to 4.5 [5.3 to 39.8]	3.0	6.0	630 [1.39]	•		•	•	•	•	•	•	•	•	DCC0241X-AZ				
			DLV45C12P-AY						•	•	•	•	•	•	•	•	•	•		•	•	•
15		C Series (Current control type)	DLV04C10L-AY	0.05 to 0.4 [0.4 to 3.5]	1.2	3.0	370 [0.82]	•		•	•	•	•	•	•	•	•	DCC0101X-AZ				
			DLV10C10L-AY	0.2 to 1.0 [1.8 to 8.9]	1.8	4.0		•		•	•	•	•	•	•	•	•	•		•	CE	
18		S Series (Variable speed type)	DLV30S06L-AY	0.4 to 3.0 [3.5 to 26.6]	2.6	5.0	710 [1.57]	•		•	•	•	•	•	•	•	•	DEA0151N-AZ or DEA0241N-AZ				
			DLV30S06P-AY						•	•	•	•	•	•	•	•	•			•	•	•
			DLV30S12L-AY						•	•	•	•	•	•	•	•	•			•	•	•
			DLV30S12P-AY						•	•	•	•	•	•	•	•	•			•	•	•
			DLV30S20L-AY	2.0 to 4.5 [17.7 to 39.8]	4.5	6.0	860 [1.90]	•		•	•	•	•	•	•	•	•	•		•	DEA0151N-AZ or DEA0241N-AZ	
			DLV30S20P-AY						•	•	•	•	•	•	•	•	•	•		•		
			DLV45S06L-AY						•	•	•	•	•	•	•	•	•	•		•		•
			DLV45S06P-AY						•	•	•	•	•	•	•	•	•	•		•		•
DLV45S12L-AY	3.8 to 7.0 [33.6 to 62.0]	5.0	8.0	860 [1.90]	•		•	•	•	•	•	•	•	•	•	•	DEA0151N-AZ or DEA0241N-AZ					
DLV45S12P-AY						•	•	•	•	•	•	•	•	•	•	•		•				
DLV70S06L-AY		•	•	•	•	•	•	•	•	•	•	•	•	•	•	•	DEA0241N-AZ					
DLV70S06P-AY		•	•	•	•	•	•	•	•	•	•	•	•	•	•	•						
22		A Series (Low voltage, ESD type)	DLV30A06L-AY	0.4 to 3.0 [3.5 to 26.6]	2.6	5.0	690 [1.52]	•		•	•	•	•	•	•	•	•	DEA0151N-AZ or DEA0241N-AZ				
			DLV30A06P-AY						•	•	•	•	•	•	•	•	•			•	•	
			DLV30A12L-AY						•	•	•	•	•	•	•	•	•			•	•	•
			DLV30A12P-AY						•	•	•	•	•	•	•	•	•			•	•	•
			DLV30A20L-AY	2.0 to 4.5 [17.7 to 39.8]	4.5	6.0	840 [1.85]	•		•	•	•	•	•	•	•	•	•		•	DEA0151N-AZ or DEA0241N-AZ	
			DLV30A20P-AY						•	•	•	•	•	•	•	•	•	•		•		
			DLV45A06L-AY						•	•	•	•	•	•	•	•	•	•		•		•
			DLV45A06P-AY						•	•	•	•	•	•	•	•	•	•		•		•
DLV45A12L-AY	3.8 to 7.0 [33.6 to 62.0]	5.0	8.0	840 [1.85]	•		•	•	•	•	•	•	•	•	•	•	DEA0151N-AZ or DEA0241N-AZ					
DLV45A12P-AY						•	•	•	•	•	•	•	•	•	•	•		•				
DLV70A06L-AY		•	•	•	•	•	•	•	•	•	•	•	•	•	•	•	DEA0241N-AZ					
DLV70A06P-AY		•	•	•	•	•	•	•	•	•	•	•	•	•	•	•						
23		A Series (Low voltage, Non-ESD type)	DLV30A06L-AS	0.4 to 3.0 [3.5 to 26.6]	2.6	5.0	690 [1.52]	•		•	•	•	•	•	•	•	•	DLC70S-WGB DLR70S-WGB				
			DLV30A06P-AS						•	•	•	•	•	•	•	•	•			•	•	
			DLV30A12L-AS						•	•	•	•	•	•	•	•	•			•	•	•
			DLV30A12P-AS						•	•	•	•	•	•	•	•	•			•	•	•
			DLV30A20L-AS	2.0 to 4.5 [17.7 to 39.8]	4.5	6.0	840 [1.85]	•		•	•	•	•	•	•	•	•	•		•	DLC70S-WGB DLR70S-WGB	
			DLV30A20P-AS						•	•	•	•	•	•	•	•	•	•		•		
			DLV45A06L-AS						•	•	•	•	•	•	•	•	•	•		•		•
			DLV45A06P-AS						•	•	•	•	•	•	•	•	•	•		•		•
DLV45A12L-AS	3.8 to 7.0 [33.6 to 62.0]	5.0	8.0	840 [1.85]	•		•	•	•	•	•	•	•	•	•	•	DLC70S-WGB DLR70S-WGB					
DLV45A12P-AS						•	•	•	•	•	•	•	•	•	•	•						
DLV70A06L-AS		•	•	•	•	•	•	•	•	•	•	•	•	•	•	•	DLR70S-WGB					
DLV70A06P-AS		•	•	•	•	•	•	•	•	•	•	•	•	•	•							
27		DLV02 DLV12 DLV16	DLV02SL-CKE	0.03 to 0.2 [0.3 to 1.8]	1.0	2.2	470 [1.04]	•										DLC16S				
			DLV12SL-CKE	0.1 to 1.2 [1.3 to 10.6]	1.4	3.0		•														
			DLV16SL-CKE	0.2 to 1.6 [1.8 to 14.2]	2.2	4.0		•														
			DLV02SL-BKE	0.03 to 0.2 [0.3 to 1.8]	1.0	2.2		•														
			DLV12SL-BKE	0.1 to 1.2 [1.3 to 10.6]	1.4	3.0		•														
			DLV16SL-BKE	0.2 to 1.6 [1.8 to 14.2]	2.2	4.0		•														

[Brushless Motor - AC Power Supply]





Page	Outer Appearance	Series	Model	Torque Range (Nm [lbf·in])	Screw Size (mm)		Mass (g [lbs])	Lever Start	Push to Start	ESD Protection	Soft Stop	Low Speed	Medium Speed	High Speed	Built-in Screw Counter	SP Type (Torque-up signal output)		
					min.	max.												
25		A Series (Transformerless type) 	DLV30A06L-AB	0.4 to 3.0 [3.5 to 26.6]	2.6	5.0	700 [1.54]	•				•						
			DLV30A06P-AB					•	•									
			DLV30A12L-AB					•				•						
			DLV30A12P-AB					•	•			•						
			DLV30A20L-AB					•								•		
	DLV30A20P-AB		•	•							•							
			DLV45A06L-AB	2.0 to 4.5 [17.7 to 39.8]	4.5	6.0	870 [1.92]	•						•				
			DLV45A06P-AB					•	•									
			DLV45A12L-AB					•				•						
			DLV45A12P-AB					•	•			•						
DLV70A06L-AB		•												•				
DLV70A06P-AB	•	•							•									
25		A Series (Transformerless, Signal output type)  	DLV30A06L-SP(AB)	0.4 to 3.0 [3.5 to 26.6]	2.6	5.0	700 [1.54]	•				•				•		
			DLV30A06P-SP(AB)					•	•									
			DLV30A12L-SP(AB)					•				•						
			DLV30A12P-SP(AB)					•	•			•						
			DLV30A20L-SP(AB)					•								•		
	DLV30A20P-SP(AB)		•	•							•							
			DLV45A06L-SP(AB)	2.0 to 4.5 [17.7 to 39.8]	4.5	6.0	870 [1.92]	•						•				•
			DLV45A06P-SP(AB)					•	•									
			DLV45A12L-SP(AB)					•				•						
			DLV45A12P-SP(AB)					•	•			•						
DLV70A06L-SP(AB)		•												•				
DLV70A06P-SP(AB)	•	•							•									

List of Screwdrivers

[Brush Motor - DC Power Supply]

Page	Outer Appearance	Series	Model	Torque Range (Nm [lbf.in])	Screw Size (mm)		Mass (g [lbs])	Lever Start	Push to Start	ESD Protection	For Clean Room Use	High Speed	Low Shock	SPC Type available (for screw counter)	Controller			
					min.	max.									Model	Adjustable speed	Outer Appearance	
28		DLV7400A	DLV7410A	0.02 to 0.2 [0.2 to 1.8]	1.0	2.3	230 [0.51]	•		•			•	•	DLC1110-GG DLC1110-HE DLC1110-EN DLC1110-FE DLC1110-GE Non-CE	•		
			DLV7410HA															
	DLV7420A		0.15 to 0.4 [1.3 to 3.5]	1.6	2.6	275 [0.61]	•		•				•	•				
	DLV7419A		0.02 to 0.2 [0.2 to 1.8]	1.0	2.3		•		•	•		•						
	DLV7419HA																	
DLV7429A	0.15 to 0.4 [1.3 to 3.5]	1.6	2.6	•		•	•		•									
29		DLV5700 Non-CE	DLV5720	0.02 to 0.2 [0.2 to 1.8]	1.0	2.3	230 [0.51]	•		•			•	•	DLC0350 DLC0950 DLC0350-GG DLC0350-E DLC0350-F DLC0350-G Non-CE	•		
			DLV5720H															
			DLV5740	0.15 to 0.4 [1.3 to 3.5]	1.6	2.6	•		•			•						
			DLV5740H															
			DLV5750	0.1 to 0.55 [0.9 to 4.9]	1.0	3.0	300 [0.66]	•		•		•						
30		DLV5800U	DLV5820U	0.02 to 0.2 [0.2 to 1.8]	1.0	2.3	230 [0.51]	•		•					DLC0350-GG DLC0350-E DLC0350-F DLC0350-G Non-CE	•		
			DLV5820HU															
			DLV5840U	0.15 to 0.4 [1.3 to 3.5]	1.6	2.6		•		•								
	DLV5800 Non-CE	DLV5820	0.02 to 0.2 [0.2 to 1.8]	1.0	2.3	230 [0.51]	•		•						DLC0250E Non-CE	•		
		DLV5820H																
		DLV5840	0.15 to 0.4 [1.3 to 3.5]	1.6	2.6		•		•									
31		DLV7300	DLV7313	0.03 to 0.15 [0.3 to 1.3]	Up to 2.0		350 [0.77]	•							DLC1213A-GG DLC1213A-GGU DLC1213A-EN DLC1213A-FE DLC1213A-GE DLC1213A-HE Non-CE	•		
			DLV7323	0.05 to 0.5 [0.4 to 4.4]	1.0	3.0		•										
			DLV7333	0.3 to 1.2 [2.7 to 10.6]	2.0	3.5	400 [0.88]	•										
			DLV7325	0.05 to 0.5 [0.4 to 4.4]	1.0	3.0		•			•							
			DLV7335	0.3 to 1.2 [2.7 to 10.6]	2.0	3.5		•			•							
32		DLV7300-BME DLV7300-BKE	DLV7321	0.05 to 0.5 [0.4 to 4.4]	1.0	3.0	350 [0.77]	•		•					DLC1213A-GGB DLC1213A-ENB DLC1213A-FEB DLC1213A-HEB Non-CE	•		
			DLV7331	0.3 to 1.2 [2.7 to 10.6]		3.5		•										
			DLV7319	0.2 to 0.4 [1.8 to 3.5]	2.0	3.0	•			•								
			DLV7329	0.25 to 0.55 [2.2 to 4.9]			400 [0.88]	•			•							
			DLV7339	0.45 to 0.95 [4.0 to 8.4]				•			•							
			DLV7349	0.55 to 1.2 [4.9 to 10.6]	3.0	3.5		•			•							
33		DLV7500	DLV7530-MKE	0.5 to 1.7 [4.4 to 15.1]	2.6	4.0	650 [1.43]	•							DLC4511	•		
			DLV7530-BKE															
			DLV7540-MKE	1.2 to 2.7 [10.6 to 23.9]	3.5	5.0	•											
			DLV7540-BKE				•											
			DLV7550-MKE	2.0 to 4.5 [17.7 to 39.8]	4.5	6.0	750 [1.65]	•			•							
	DLV8500	DLV8530-MKE	0.5 to 1.7 [4.4 to 15.1]	2.6	4.0	650 [1.43]	•			•								
		DLV8530-BKE																
		DLV8540-MKE	1.2 to 2.7 [10.6 to 23.9]	3.5	5.0	•												
		DLV8540-BKE				•												
		DLV8550-MKE	2.0 to 4.5 [17.7 to 39.8]	4.5	6.0	750 [1.65]	•			•								

[Brush Motor - AC Power Supply]

Page	Outer Appearance	Series	Model	Torque Flange (Nm [lbf.in])	Screw Size (mm)		Mass (g [lbs])	Lever Start	Push to Start	ESD Protection	High Speed	SPC Type available (for screw counter)	
					min.	max.							
34		DLV7000 Non-CE	DLV7020	0.05 to 0.55 [0.4 to 4.9]	1.0	3.0	400 [0.88]	●				●	
			DLV7030	0.3 to 1.1 [2.7 to 9.7]	2.0	3.5		●				●	
			DLV7031	0.3 to 1.0 [2.7 to 8.9]		3.0		●		●	●		
		DLV8000 Non-CE	DLV8020	0.1 to 0.55 [0.9 to 4.9]	1.0	3.0	410 [0.90]		●				●
			DLV8030	0.3 to 1.1 [2.7 to 9.7]	2.0	3.5		●				●	
			DLV8031	0.3 to 1.0 [2.7 to 0.9]		3.0		●		●	●		
35		DLV7104 Non-CE	DLV7124	0.25 to 0.75 [2.2 to 6.6]	2.6	3.0	720 [1.59]	●					
			DLV7134	0.5 to 1.7 [4.4 to 15.1]		4.0		●					
			DLV7144	1.2 to 3.0 [10.6 to 26.6]	3.5	5.0		●					
		DLV8104 DLV8204 Non-CE	DLV8124	0.25 to 0.75 [2.2 to 6.6]	2.6	3.0	710 [1.57]		●				
			DLV8134	0.5 to 1.7 [4.4 to 15.1]		4.0		●					
			DLV8144	1.2 to 3.0 [10.6 to 26.6]	3.5	5.0		●					
			DLV8154	2.0 to 4.5 [17.7 to 39.8]	4.5	6.0	●						
			DLV8224	0.35 to 0.7 [3.1 to 6.2]	2.6	3.0		●		●			
			DLV8234	0.5 to 1.7 [4.4 to 15.1]		4.0	710 [1.57]	●		●			
			DLV8244	1.2 to 3.0 [10.6 to 26.6]	3.5	5.0	●						



List of Screwdrivers (For automated machines)

[Brushless Motor]

Page	Outer Appearance	Series	Model	Torque Range (Nm [lbf·in])	Screw Size (mm)		Mass (g [lbs])	Low Speed	Medium Speed	High Speed	Coupling			
					min.	max.					Standard	Flange	M41 Screw	
					Type of couplings									
43	 (The Vacuum Pickup is optional)	A Series (For automation)	DLV30A06A-N	0.4 to 3.0 [3.5 to 26.6]	2.6	5.0	700 [1.54]	●			●			
			DLV30A06A-F				760 [1.68]	●			●			
			DLV30A06A-M				740 [1.63]	●				●		
			DLV30A12A-N				700 [1.54]		●		●			
			DLV30A12A-F				760 [1.68]		●		●			
			DLV30A12A-M				740 [1.63]		●			●		
			DLV30A20A-N				700 [1.54]			●	●			
			DLV30A20A-F				760 [1.68]			●		●		
			DLV30A20A-M	740 [1.63]			●		●					
			DLV45A06A-N	2.0 to 4.5 [17.7 to 39.8]	4.5	6.0	780 [1.72]	●			●			
			DLV45A06A-F				840 [1.85]	●				●		
			DLV45A06A-M				820 [1.81]	●				●		
			DLV45A12A-N				780 [1.72]		●		●			
			DLV45A12A-F				840 [1.85]		●			●		
			DLV45A12A-M				820 [1.81]		●			●		
			DLV70A06A-N	3.8 to 7.0 [33.6 to 62.0]	5.0	8.0	780 [1.72]	●			●			
DLV70A06A-F	840 [1.85]	●							●					
DLV70A06A-M	820 [1.81]	●							●					
	820 [1.81]	●							●					



Standard coupling



Flange coupling



M41 screw coupling

[Brush Motor]

Page	Outer Appearance	Series	Model	Torque Range (Nm [lbf·in])	Screw Size (mm)		Mass (g [lbs])	Controller	
					min.	max.		Model	
45		DLV3100 (For automation)	DLV3121	0.25 to 0.7 [2.2 to 6.2]	2.3	2.6	900 [1.98]	Transformerless (controller not required)	
			DLV3131	0.5 to 1.5 [4.4 to 13.3]	2.6	3.5			
			DLV3141	1.2 to 3.0 [10.6 to 26.6]	3.5	5.0			
			DLV3151	2.0 to 4.5 [17.7 to 39.8]	4.5	6.0			
			DLV3300 (For automation)	DLV3321	0.05 to 0.5 [0.4 to 4.4]	1.0	3.0	400 [0.88]	DLC3310
DLV3331	0.3 to 1.2 [2.7 to 10.6]	2.0	3.5						

Selection Chart

This chart is for reference only.

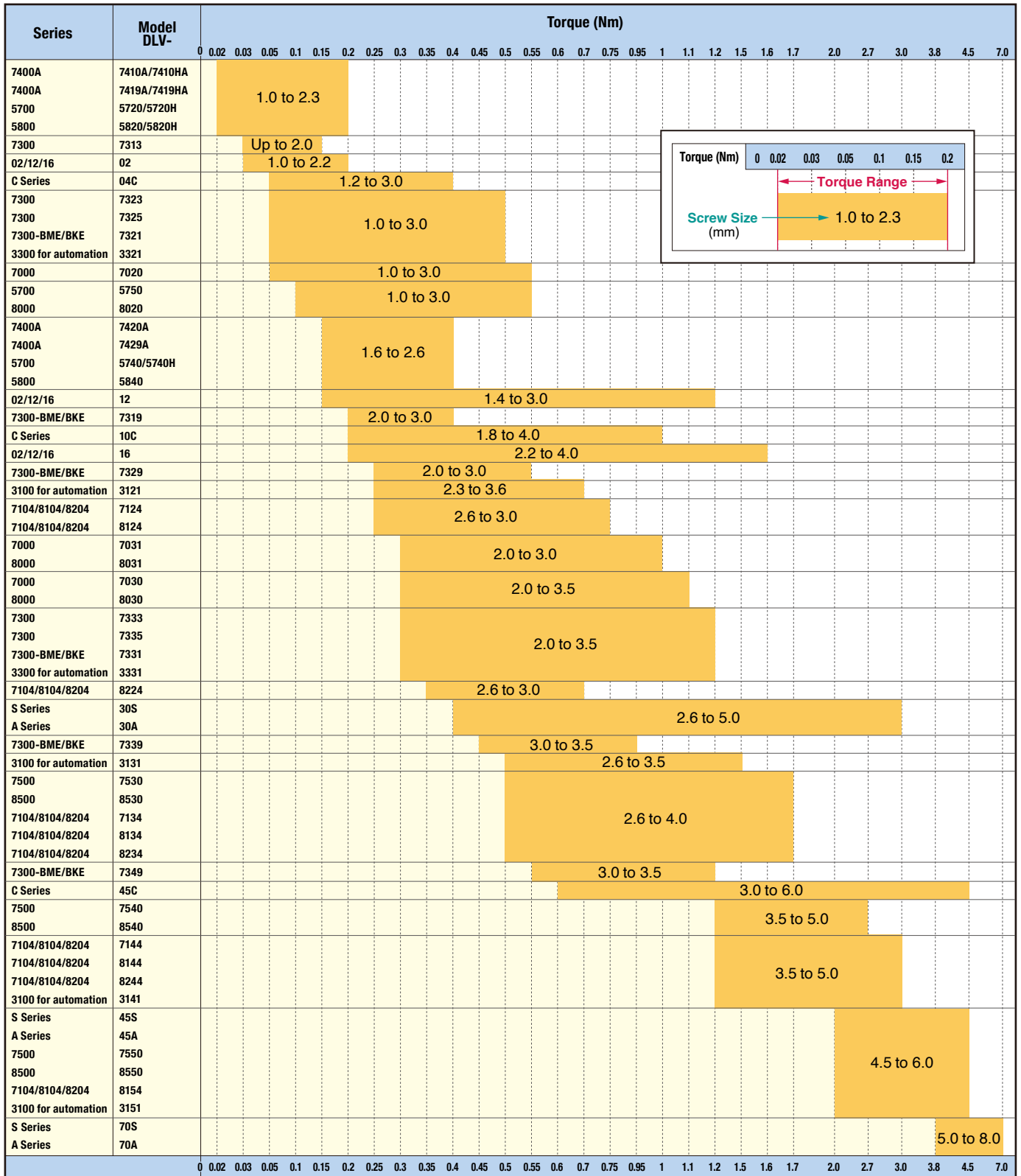

Low Voltage (DC)
 Brush motor **Brushless motor**
 Miniature screw **Precision screw** **Machine screw**
3.0 to 6.0 mm

See page 53 for External Dimensions

Delvo Brushless Type



C Series (Current control type)

Model **DLV45C**



DCC0241X-AZ



DLV45C12L



DLV45C12P

Features

- Current Controlled Torque System suitable for screw fastening work
- Low-voltage brushless motor
- ESD (Electrostatic Discharge) protection structure
- For both hand-held / automatic machines
- Controller has built in counting function. Prevents human errors
- Nine speed settings available
- Automatic three step speed control function
- Two types of measuring methods (Time/Motor rotation signal)
- Seven color indication LED (At the tip of the screwdriver)
- Two external I/O signal connection ports (NPN ⇄ PNP switchable, RS-232C)
- Various settings can be configured via a PC (Free setting software available on Nitto Kohki website)

Thirty different torque settings can be set on a single screwdriver !

Torque and fastening setting of thirty screwdrivers can be consolidated into one.

1st unit	2nd unit	3rd unit	...	30th unit
1.2 Nm 1000 min ⁻¹	1.8 Nm 500 min ⁻¹	3.0 Nm 800 min ⁻¹		3.0 Nm 400 min ⁻¹



Torque **0.6 to 4.5 Nm** range [5.3 to 39.8 lbf·in]
 Lever Start / Push to Start

- Two types of fastening mode available subject to the workpiece and fastening conditions.
- Coordinate the actual workpieces, screws and operating conditions and determine the fastening mode, torque range and rotation speed.

Specifications

Model		Bit	DLV45C12L-AY : K	DLV45C12P-AY : K
Starting Method			Lever Start	Push to Start
Power Source			From dedicated controller	
Torque Adjustment			From 1 to 100% in 1% increments	
Torque		(Nm [lbf·in])	0.6 to 4.5 [5.3 to 39.8]	
Free speed	SOFT fastening setting	(min ⁻¹)	400 to 1200	
		Speed Level	Level 1 to 9	
	HARD fastening setting	(min ⁻¹)	100 to 700	
		Speed Level	Automatically set by torque setting	
Power Consumption		(W)	44	
Screw Size	Machine Screw	(mm)	3.0 to 6.0	
	Tapping Screw	(mm)	2.5 to 5.0	
Bit Type		(mm)		
Mass		(kg [lbs])	0.63 [1.39]	
Rated Operation			ON: 0.5 seconds / OFF: 3.5 seconds	
Bit Grounding			Equipped as standard	
Standard Accessories			Bit NK35 (No.2x7x75): 1 pc. Connection Cord 2 m (DLW9078): 1 pc. Suspension Bail: 1 pc.	

Model	DCC0241X-AZ
Power Source	100 - 240 V AC, 50/60 Hz
Output Voltage	40 V DC
Input Signal Method	Photocoupler input (24 V DC drive (5 mA/1 input), NPN/PNP switchable)
Output Signal Method	Photocoupler output (30 V DC or less, 80 mA/1 output or less, NPN/PNP switchable)
Service Power Source	24 V DC (Maximum capacity 200 mA)
Serial Signal Method	RS-232C
ESD (Electrostatic Discharge) Protection	Adopted (IEC61340-5-1 compliant)
Mass	(kg [lbs]) 1.8 [3.97]
Power Cord 2 m (Optional)*	DLW9220 / DLW9240 / DLW9250

Caution

- *Speed and torque differs depending on the temperature. (Use within the range of +10 to +40°C)
- *Do not retighten screws that are already tightened. The torque will become larger than the set torque.

About optional accessories (See page 14)

- *The power cord for the controller (DCC0241X-AZ) is sold separately. Ask us for the required power cord when ordering.
- *For torque measurements, please use Nitto Kohki's Torque Checker and Soft Joint / Hard Joint (sold separately).



SOFT / HARD fastening Settings

SOFT fastening setting

Suitable for workpieces with high fastening load such as tapping screws or fastening soft objects such as rubber.

Timing chart

The image of the control action, seating the screw at the set rotation speed.

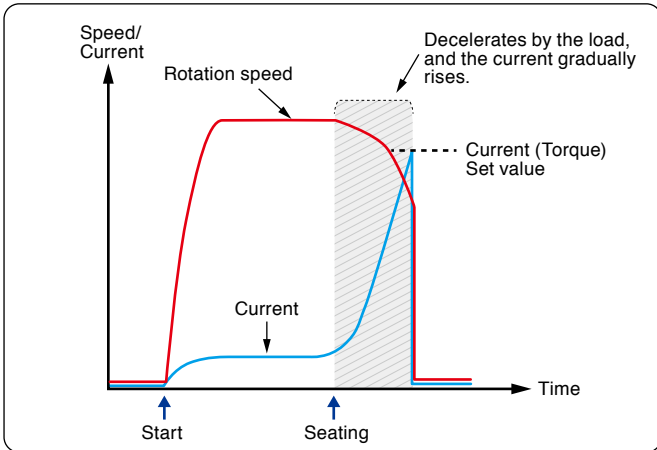

HARD fastening setting

Suitable for workpieces with small fastening load such as threaded holes or rigid bodies such as metal.

Timing chart

A control that seats the screw at the seating rotation speed according to the torque setting value, when the initial speed time / midterm speed time is elapsed.

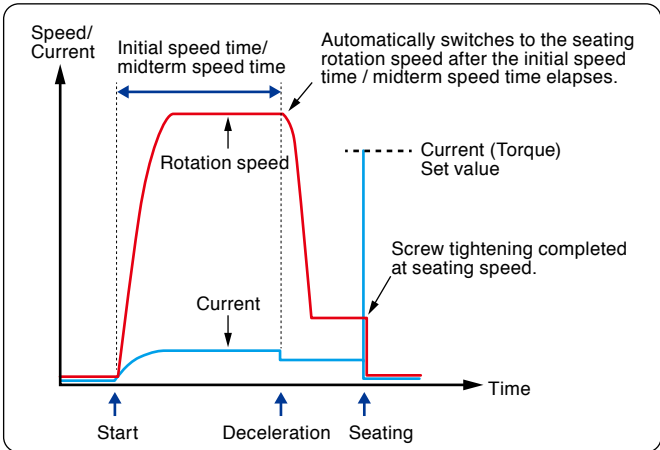

Torque range: Output Torque and Rotation Speed

There are nine levels for rotation speed setting. (400 to 1200 min⁻¹)
Corresponds to high torque fastening, even at SOFT fastening setting or slow rotation speed.

Torque Range of SOFT fastening setting

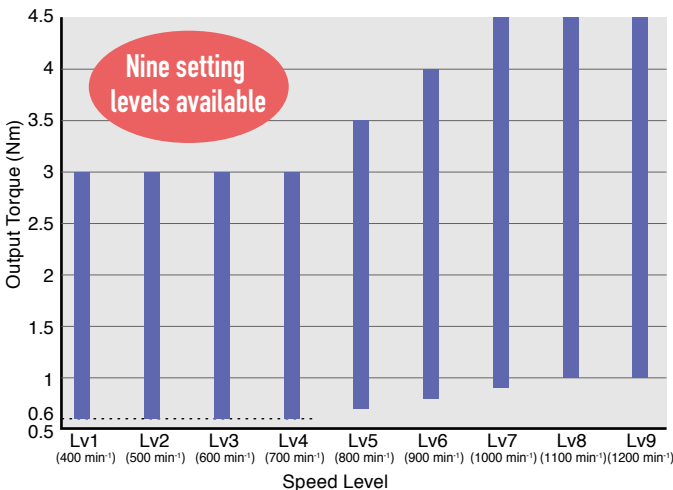

Torque Range of HARD fastening setting

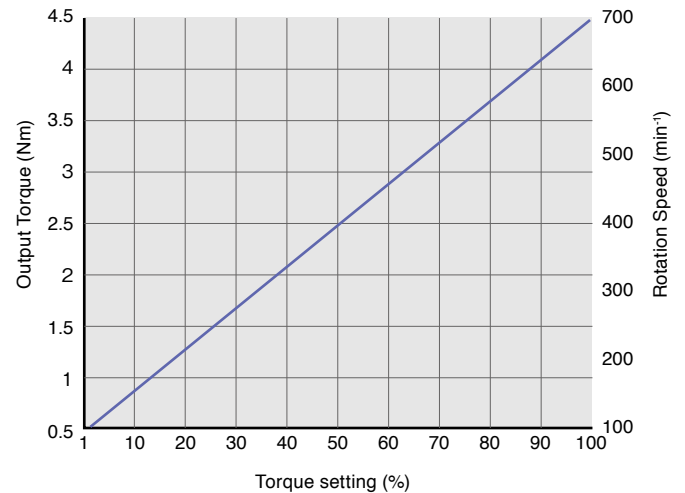

*When measuring the torque with Torque Checker, use Soft Joint (DLW4050) for SOFT fastening setting, use Hard Joint (DLW4040) for HARD fastening setting. (See page 14)

Two safety functions

1. Caution mode

A torque value that alerts the operator can be set. After the channel is switched, if the torque exceeds the preset value, a warning is displayed on the counter and the electric screwdriver will not start.

****CAUTION****
HIGH TORQUE



Flashes in yellow

2. Refastening prohibited time setting

To prevent additional fastening (second tightening, confirmation tightening, etc.), it can be set so that it does not restart after torque-up (for 0.0 to 9.9 seconds).

Adjust the set value according to the skill level of the operator and the interval between screw fastening operations.



Controller



Flashes in red

Rotation speed: Built-in automatic speed control function

Built-in automatic three step variable speed control function. Enables compatibility of "quality of slow speed" and "efficiency of high speed".



◇ Timing chart (Below rotation speeds and times are examples)

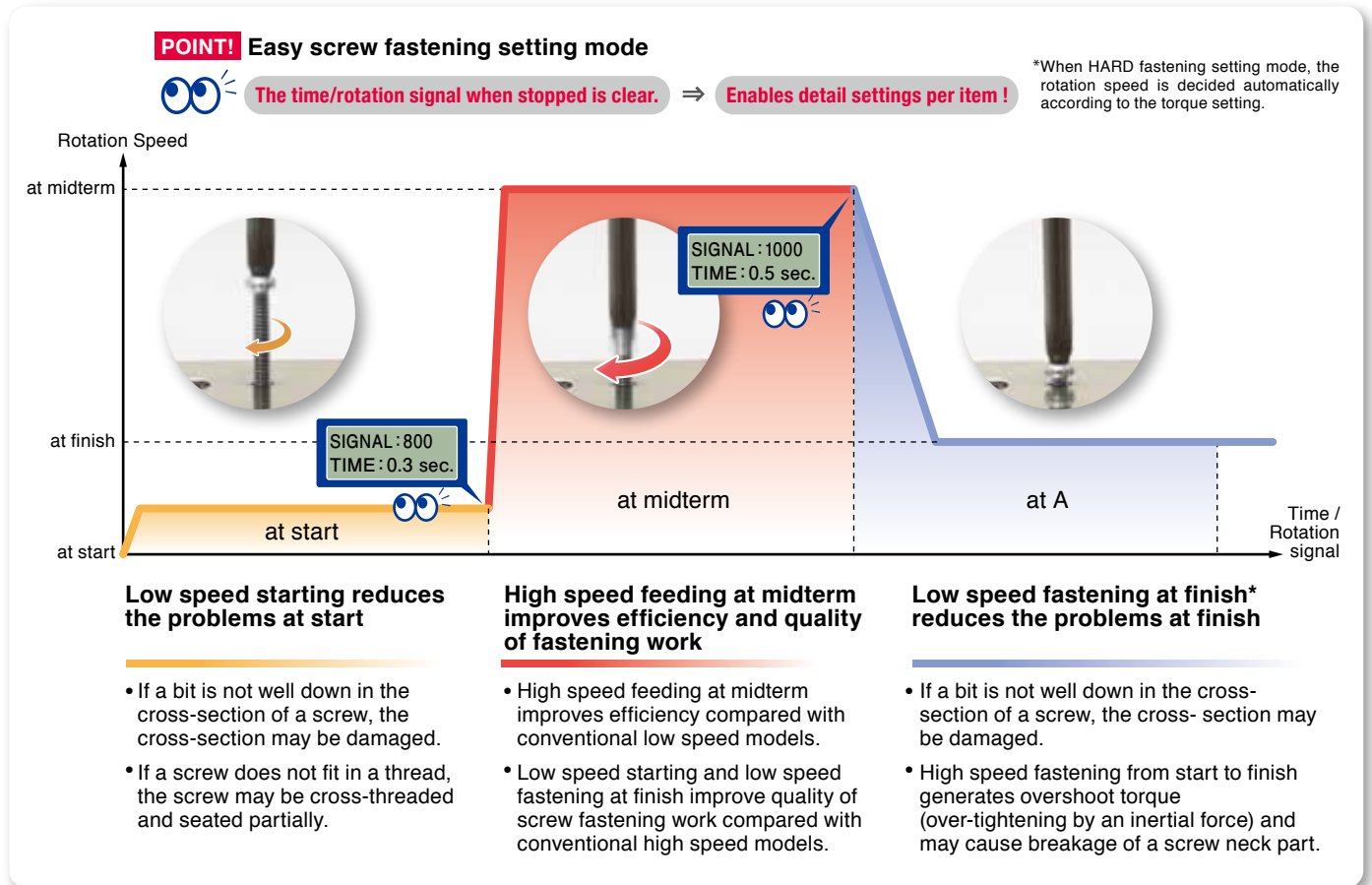

Screw fastening time measuring (Upper / Lower limit)

The upper / lower limit of screw fastening time (correct timer) can be set. It will be judged as "correct fastening" only when the measured time is between the upper limit and lower limit. Either limit can be switched off. (Below times are examples)

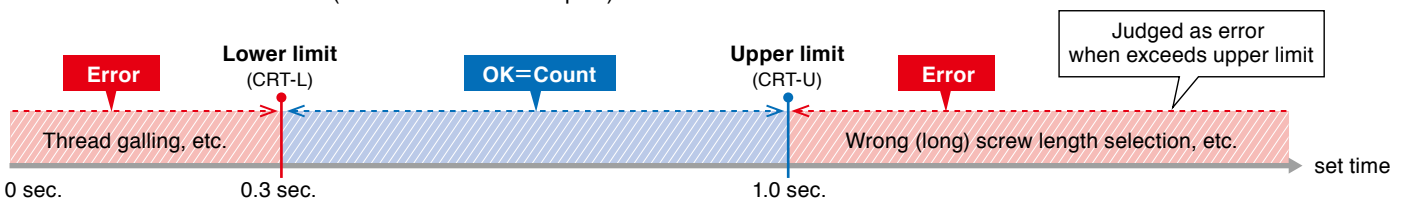

Two types of measuring methods

There are two methods to measure the setting time of start and midterm.

TIME
Measure by time. You can decide the setting value intuitively.

MOTOR SIGNAL
Measure by the motor rotation signal. Even if you change the rotation speed, you do not need to set the measurement time or rotation time.

Rotation direction setting

Specify the rotation direction of forward rotation. "RIGHT" for clockwise, "LEFT" for counterclockwise.

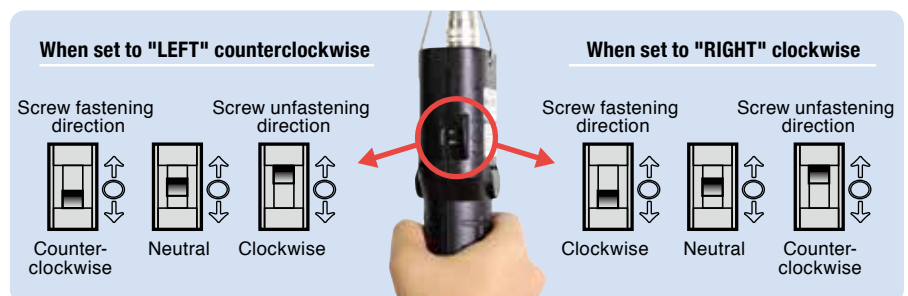



Channel setting

The unit of fastening work performed continuously under the same conditions is called a "channel". Up to thirty channels can be registered in the memory.

Register up to 30 channels //



◇ Example of motion setting

Channel	CH1	CH2	CH3	CH4	CH30
1: Screw fastening mode	SOFT	SOFT	HARD	SOFT	HARD
2: Number of screw fastening	2 pcs.	13 pcs.	5 pcs.	3 pcs.	20 pcs.
3: Speed level at finish	Lv5	Lv9	AUTO	Lv1	AUTO
4: Torque	10%	80%	30%	45%	20%
5: Speed level at start	Lv1	OFF	Lv9	Lv3	Lv1
6: Rotation time at start	0.1 sec.	—	0.3 sec.	0.8 sec.	1.0 sec.
7: Speed level at midterm	Lv9	OFF	OFF	Lv8	Lv7
8: Rotation time at midterm	0.5 sec.	—	—	1.2 sec.	0.5 sec.
9: Speed level at reverse rotation	Lv9	Lv9	Lv7	Lv5	Lv5
⋮	⋮	⋮	⋮	⋮	⋮
26: Rotation direction	RIGHT	RIGHT	RIGHT	LEFT	RIGHT

Channel pattern setting

A series of operations combining each channel is called a "channel pattern". Up to eight channels can be registered per channel pattern. Up to thirty channel patterns can be set. When combining nine or more channels, use multiple channel patterns.

Combination up to eight channels //

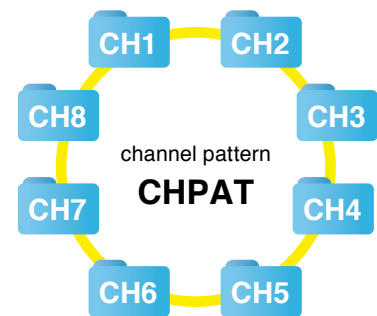

◇ Example of channel pattern

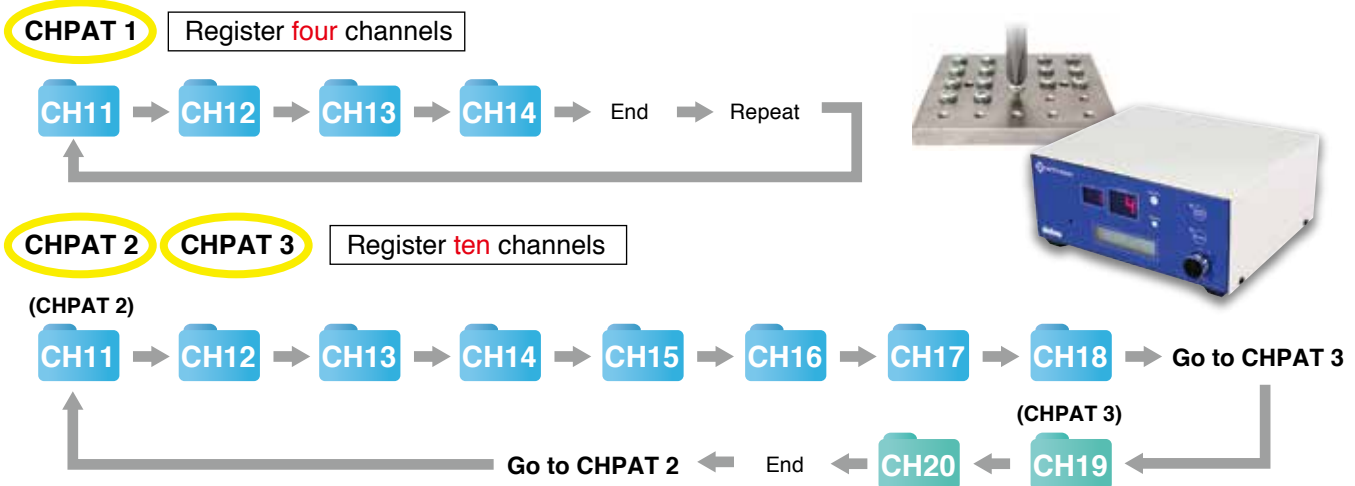

Easy setting with dedicated software

Channels and Channel patterns can be easily set with dedicated software. Download free from our website.



www.nitto-kohki.co.jp/e/prd/delvo/software/

Auto reverse function

The screwdriver automatically reverses after torque-up or reaching the preset time. Auto reverse mode can be used for temporarily fastening screws or verifying tapped holes.

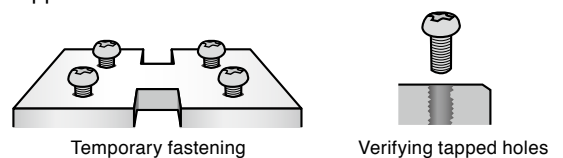

External I/O signal

When connecting to an external device, it can be connected in two ways.

1. External I/O Cable

Use External I/O Cable DLW9091. Compatible with both NPN/PNP. It can be wired according to the externally connected equipment.

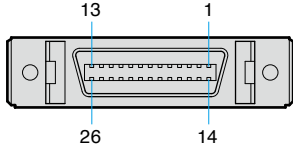

Connector: IEEE1284 half pitch connector (26-pin)

Terminal No.	Function	Details	I/O
1	+24 V DC	Built-in service power supply (Capacity: Maximum 200 mA)	Service power supply
2	0 V DC		
3	Input signal common terminal	Input signal common terminal (See page 49 of instruction manual)	Input
4	Output signal common terminal	Output signal common terminal (See page 50 of instruction manual)	Output
5	Switching signal A	Specify channel or channel pattern using a 5-bit input signal.	Input
6	Switching signal B		
7	Switching signal C		
8	Switching signal D		
9	Switching signal E		
10	Forward rotation start	Startup with external input signal.	Input
11	Reverse rotation start	The electric screwdriver operates while the input signal is ON.	
12	Workpiece	Input workpiece signal (workpiece detection signal output). Workpiece signal is ON while input signal is ON.	Output
13	External reset	Input external reset signal	
14	Forced stop	Input the forced stop signal	
15	Channel A	The channel being operated or being set is ON	
16	Channel B		
17	Channel C		
18	Channel D		
19	Channel E		
20	Forward rotation signal	Output signal is ON during forward rotation	
21	Reverse rotation signal	Output signal is ON during reverse rotation	
22	Operation OK	Output signal is ON when the screw fastening of the set count is complete and judged as operation OK (PASS).	
23	Count up	Output signal ON for 0.3 seconds when screw fastening is normal (at torque-up).	
24	Operation NG	Output signal ON when workpiece signal is OFF during operation and judged as operation NG (FAIL).	
25	Screw fastening NG	Output signal ON for 0.3 seconds when screw fastening is NG (FAIL).	
26	N/A	No connection	—

2. RS-232C

Use Communication Cable (Straight-through) DLW9092 to connect with PCs or sequencers (PLC).

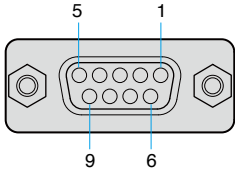

Connector pin layout (D-SUB 9-pin (female))

◆ Specifications (RS-232C)

Transmission method	Asynchronous (asynchronous communication)
Communication line	Full duplex
Transmission speed	38400 bps
Number of data	8
Parity	None
Stop bit	1
Handshake	None
Delimiter (communication separator)	Receive: CR+LF (\r\n) Send: CR+LF (\r\n)

Pin No.	Signal name	I/O
2	TxD	OUT (This tool→PC)
3	RxD	IN (PC→This tool)
5	GND	GND

*Other pins are not used

◆ Send / receive commands

Operation	Send command	Response from controller
Forward rotation drive	FWD\r\n	FWD\r\n
Reverse rotation drive	RVS\r\n	RVS\r\n
Drive stop	STP\r\n	STP\r\n
Switching channel / channel pattern *1	MOV:p\r\n (p=1 to 30)	At channel switching CH :p\r\n At channel pattern switching CHP:p\r\n
Screw count reset	CRT\r\n	CRT\r\n
Workpiece reset	WRT\r\n	WRT\r\n
Workpiece signal ON	WIN\r\n	WIN\r\n
Workpiece signal OFF	WOT\r\n	WOT\r\n
Resend request *2	RSD:p\r\n (p=1 to 10)	Command sent nth time before, specified by the parameter value
Forced stop	FSP\r\n	FSP\r\n
Canceling a forced stop	FSC\r\n	FSC\r\n

*1 The switching target differs depending on the setting of the common setting "Channel change type" (CH CHANGE). When the channel pattern is switched, the channel is also switched, so the responses are sent continuously.

*2 Up to the latest ten commands sent from the controller to the PC or sequencer are stored.

When signals could not be received correctly due to noise or some other reason, the command of nth time before, specified by the parameter will be sent from the PC or sequencer.

[Example] Send command "RSD:3\r\n" Returns the command sent by the controller three times before.

Since control is performed even when communication between the controller and PC or sequencer fails, use this function when you wish to maintain the reliability of transmission and reception. This command transmission is not included in the ten commands that are stored.



















◆ Notification command

Operation	Notification from controller
At forward rotation drive start	FWD\r\n
At reverse rotation drive start	RVS\r\n
At drive stop completion	STP\r\n
Operation OK (PASS) notification	OK\r\n
Workpiece signal ON	WIN\r\n
Workpiece signal OFF	WOT\r\n
Count up (screw fastening completes normally) notification p = Measured fastening time or signal is output	CUP:p\r\n (p=1 to 60000)
Operation NG (workpiece out while fastening count remaining) notification	WNG\r\n
Screw fastening NG (FAIL) notification p1=Screw fastening NG (FAIL) No. p2=Measured fastening time or signal is output	FNG:p1:p2\r\n
At channel switching	CH :p\r\n (p=1 to 30)
At channel pattern switching	CHP:p\r\n (p=1 to 30)
When a non-supported command or parameter is input	CER\r\n
Forced stop	FSP\r\n
Canceling a forced stop	FSC\r\n

In addition to RS-232C signals, commands are sent from the controller to the PC or sequencer (PLC) when processing is performed manually or by contact signals.

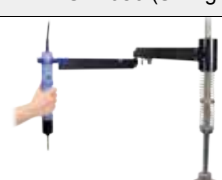

Optional Accessories

<p>Grounded 3-Prong Power Cord 2 m</p> <p>DLW9220 North America DLW9240 Europe DLW9250 UK</p> 	<p>Diamond Shape Flange Coupling DLW9017</p> <p>See page 54</p>  <p>For mounting on automated screw fastening machines</p>	<p>Flange Coupling DLW9019</p> <p>See page 54</p>  <p>For mounting on automated screw fastening machines</p>	<p>Screw Vacuum Pump DLP2530 (100 V AC) / DLP2570 (230 V AC)</p> <p>See page 51</p>  <p>Connect the tube to the vacuum pickup port. The vacuum will pick up the screw.</p>
<p>Vacuum Sleeve DLS4000 series</p> <p>See page 49</p>  <p>Select according to the screw shape</p>	<p>Vacuum Pickup DLP7401-K</p> <p>See page 49</p>  <p>For screw vacuum pickup *DLS4220/DLS4221 included</p>	<p>Torque Checker DLT1673A</p> <p>See page 46</p>  <p>For torque control of screwdrivers</p>	<p>Rubber Grip DRG1000 (Non-ESD)</p>  <p>For anti-slip when fastening</p>
<p>Pistol Grip DLW2300ESD</p> <p>See page 51</p>  <p>ESD Protection</p> <p>For operator fatigue reduction, suitable for horizontal fastening</p>	<p>Soft Joint DLW4050</p> <p>See page 46</p>  <p>Bit is included</p> <p>The bit for measuring is included. (NK35BN 13×19×10×75)</p> <p>For SOFT fastening torque measurement</p>	<p>Hard Joint DLW4040</p> <p>See page 46</p>  <p>Bit is optional</p> <p>The bit for measuring is not included. (NK35BN 13×19×10×75)</p> <p>For HARD fastening torque measurement</p>	<p>Connection Cord 2 m DLW9078</p> <p>Standard accessory of screwdrivers</p>  <p>Connects controller and screwdriver</p>
<p>Extension Cord 3 m DLW9310</p>  <p>Extends cord length between controller and screwdriver</p>	<p>External I/O Cable 3 m DLW9091</p>  <p>Connect when using external signals</p>	<p>Communication Cable 3 m (Straight-through) DLW9092</p>  <p>Connect to PCs and PLCs (sequencers) when using external signals</p>	<p>Communication Cable 3 m (Crossover) DLW9093</p>  <p>Connect controllers to transmit settings</p>
<p>Torque Reaction Arm DRA-SW-650 (Swing type)</p> <p>See page 50</p> 	<p>Torque Reaction Arm DRA-SL-650 (Slide type)</p> <p>See page 50</p> 	<p>Torque Reaction Arm DRA-TS-1000 (Telescope type)</p> <p>See page 50</p>  <p>For reducing reaction force to an operator Vertical tightening to the workpiece improves quality of the work</p>	
<p>Screw Fastening Monitor DTM45</p> <p>See page 50</p>  <p>For traceability management! Outputs torque value from a screwdriver (converted value)</p>	<p>Floating Unit DLW9510</p>  <p>For mounting on automated screw fastening machines</p>	<p>L Type Flange Attachment DLW9520</p>  <p>For mounting on automated screw fastening machines</p>	

Low Voltage (DC)
 Brush motor **Brushless motor**
 Miniature screw Precision screw Machine screw
1.2 to 4.0 mm

See page 53 for External Dimensions

Delvo Brushless Type



C Series (Current control type)

Model DLV04C/DLV10C

Features

- Easy fastening setting by controller
- Current Controlled Torque System suitable for screw fastening work
- Low-voltage brushless motor
- ESD (electrostatic discharge) protection structure
- For both hand-held / automatic machines
- Controller has built in counting function. Prevents human errors

Four screwdrivers can be consolidated into one

*The range varies depending on SOFT fastening or HARD fastening.
 *When the same bit is used.



DCC0101X-AA

Controller can be set to any torque and speed within range.

Torque:

DLV04C 0.05 to 0.4 Nm [0.44 to 3.54 lbf · in]

DLV10C 0.2 to 1.0 Nm [1.77 to 8.85 lbf · in]

Speed: 100 to 1000 min⁻¹

All in one!

0.25 Nm	450 min ⁻¹		1st unit
0.15 Nm	600 min ⁻¹		2nd unit
0.35 Nm	1000 min ⁻¹		3rd unit
0.30 Nm	450 min ⁻¹		4th unit

Torque 0.05 to 1.0 Nm range
 [0.4 to 8.9 lbf·in]

Easily adapts for use in automatic machines

The sequencing of the screwdrivers can be controlled by a PLC.



DLP6650

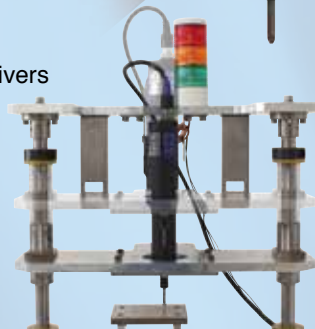

For installation on automatic assembly machines, attach optional flange coupling (DLW9015) or vacuum pickup (DLP6650).

Built-in Screw Fastening Counter Function

Controller has built in counting function. Prevents human errors.



Specifications

Model	Bit	DLV04C10L-AY	K	DLV10C10L-AY	K
		Lever start			
From dedicated controller					
Adjustment from 1 to 100% in 1% increments					
Torque (Nm [lbf·in])	SOFT fastening setting (1000 min ⁻¹ setting)	0.05 to 0.4	[0.4 to 3.5]	0.2 to 1.0	[1.8 to 8.9]
	SOFT fastening setting (600 min ⁻¹ setting)	0.05 to 0.35	[0.4 to 3.1]	0.2 to 0.45	[1.8 to 4.0]
	HARD fastening setting	0.05 to 0.4	[0.4 to 3.5]	0.2 to 1.0	[1.8 to 8.9]
Free Speed (min ⁻¹)	SOFT fastening setting	600 to 1000			
	HARD fastening setting	100 to 1000			
Power Consumption (W)		30			
Screw Size (mm)	Machine screw	1.2 to 3.0		1.8 to 4.0	
	Tapping screw	1.1 to 2.5		1.6 to 3.5	
Bit Type		NK35 (OD6.35 mm [1/4"]) Hex. Shank			
Mass		370 g [0.82 lbs]			
Rated Operation		ON: 0.5 seconds / OFF: 3.5 seconds			
Bit Grounding		Equipped as standard			
Standard Accessories		• Bit NK35(No.0 x 4 x 75): 1 pc. • Bit NK35(No.1 x 4 x 75): 1 pc. • Bit NK35(No.1 x 4 x 75): 1 pc. • Bit NK35(No.2 x 4 x 75): 1 pc. • Bit NK35(No.2 x 4 x 75): 1 pc. • Connection Cord 2 m (DLW9075): 1 pc. • Connection Cord 2 m (DLW9075): 1 pc. • Suspension Bail: 1 pc. • Suspension Bail: 1 pc.			

Please contact us for 4 mm bit type ("M" Bit).

Model	DCC0101X-AZ	P*1
Power Source	100 - 240 V AC, 50/60Hz	
Operation Channel Function	Torque and speed setting in 4-channel memory Can switch to any operation channel	
Count Function	Tracks screws fastened Workpiece detector can be incorporated	
External Start up Control Function	Start up control can be enabled by external input signal	
Output Voltage	24 V DC	
Input Signal Method	Photocoupler input (24 V DC drive (5 mA/1 input), respond to PNP output)	
Output Signal Method	Photocoupler output (30 V DC or less, 30 mA/1 output or less, PNP output method)	
Service Power Source	24 V DC (Maximum capacity 200 mA)	
Power Consumption	When on standby: 20 W During electric screwdriver rotation (rated): 30 W	
Mass	1100 g [2.4 lbs]	
ESD (Electrostatic Discharge) Protection	Adopted (IEC61340-5-1 compliant)	
Power Cord 2 m (Optional)*2	DLW9220 / DLW9240 / DLW9250	





*1) DCC0101X-AZ N with NPN output also available

*2) The power cord is sold separately.

Ask us for the required power cord when ordering. (see page 17 "Optional Accessories")



Comparison of Adjustment Method with Conventional Model

<p>Torque adjustment</p>  <p>Torque is adjusted by turning the adjustment ring at the end of the screwdriver.</p>	 <p>Can be set with the external controller. No need to adjust the screwdriver body.</p>
<p>Conventional</p>	<p>C Series</p>
<p>Speed setting</p>  <p>The speed of transformerless type screwdrivers is fixed for each series.</p>	 <p>Can be set with the external controller. Adjustable between 100 to 1000 min⁻¹.</p>



SOFT / HARD Fastening Settings

Two types of fastening mode available subject to the workpiece. Coordinate the actual workpieces, screws and operating conditions and determine the fastening mode.

SOFT fastening setting

Suitable for workpieces with high fastening load such as tapping screws or fastening soft objects such as rubber.

HARD fastening setting

Suitable for workpieces with small fastening load such as threaded holes or rigid bodies such as metal.

FSTN-T (Fastening Timer)

Can be set when "HARD" fastening setting is selected. By increasing the rotation speed during no-load fastening time prior to seating, the overall fastening time is reduced.

- ① Example with Fastening Timer**
 Speed: 800 min⁻¹
 Torque: 15%
 Fastening Timer: **0.5 sec**
- ② Example without Fastening Timer**
 Torque: 15%
 Fastening Timer: **0 sec**

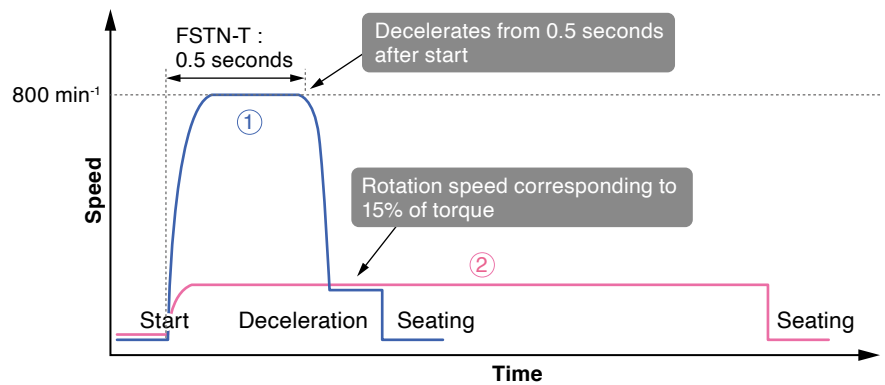

Output Torque and Rotation Speed

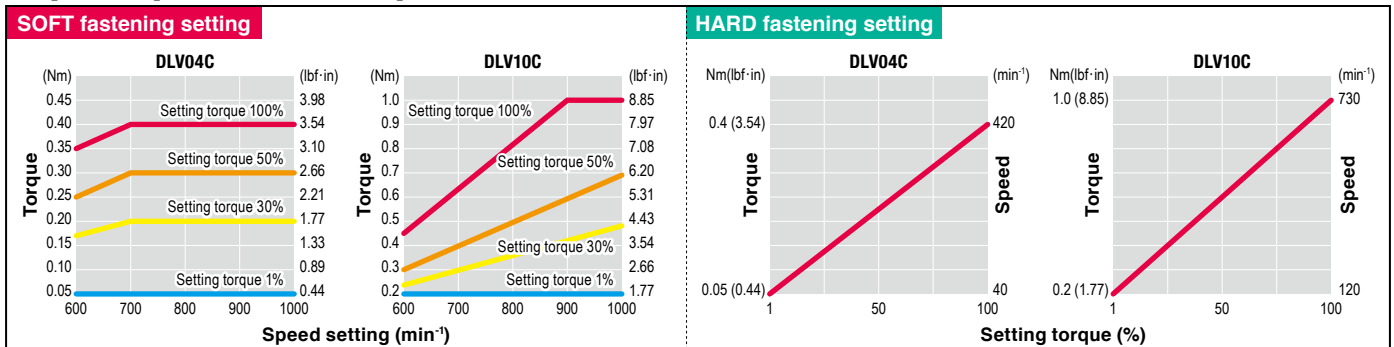

*The graph is for guidance only. The output torque range is not guaranteed.

External Signals

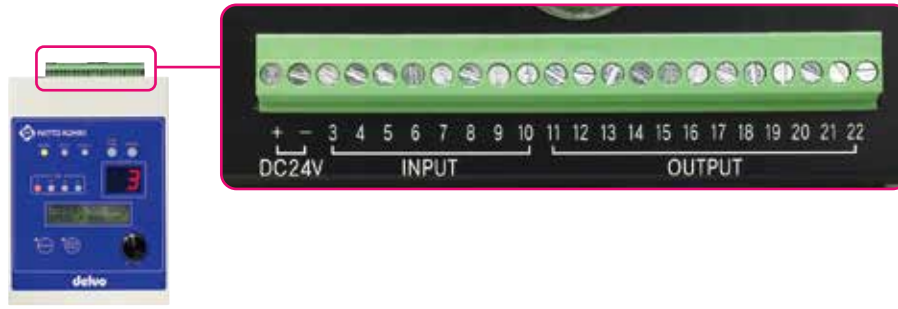















You can input or output external signals via a signal terminal block.

Terminal No.	Function	Details	I/O
1 (+)	+24 V DC	Built-in service power source (Capacity: Maximum 200 mA)	Service power source
2 (-)	0 V DC	• Use in power source for input/output signal common wire, or for the workpiece detection sensor, etc.	
3	Channel A	In the 2-bit input signal, specify the operation channel (CH1 to CH4) • Valid only when "operation channel switching method" (No.1 CH-CHG) is set to "INPUT"	Input
4	Channel B		
5	Forward rotation startup	Startup with external input signal	
6	Reverse rotation startup		
7	WORK	Input the workpiece signal (workpiece detection sensor output) • With "count function" (No.11 COUNT-FNC) and "workpiece signal" (No.12 WORK-SNSR) set to ON, the workpiece signal input is valid	
8	WORK RESET	Reset operation (same as controller [WORK RESET] button)	
9	Keylock	Lock the controller button operation • Disable the controller button operation, and prevent setting changes by the operator	
10	Input signal negative common wire	Connect 0 V DC* • Service power source (terminal No.2) or external 0 V DC power source can be connected	Output
11	Forward rotation signal	Set output signal during forward rotation to ON	
12	Reverse rotation signal	Set output signal during reverse rotation to ON	
13	Count-up (C-UP)	Performance of normal screw tightening (torque-up) sets output signal to 0.3 seconds ON	
14	Screw fastening NG (F-NG)	If screw fastening NG, sets output signal to 0.3 seconds ON	
15	Operation channel 1 (CH1)	Set the channel output signal to ON during operation or settings	
16	Operation channel 2 (CH2)		
17	Operation channel 3 (CH3)		
18	Operation channel 4 (CH4)		
19	Operation OK	If the set count screw tightening is judged to be completed and operation OK, the output signal is set to ON	
20	Operation NG	When the WORK input signal is OFF during an operation, and the operation is judged to be NG, the output signal is ON	
21	Space	Connection impossible	
22	Output signal positive common wire	Connect +24 V DC* • Service power source (terminal No.1) or external +24 V DC can be connected	

*When PNP output

Optional Accessories

Grounded 3-Prong Power Cord 2 m DLW9220 North America DLW9240 Europe DLW9250 UK	Screw Fastening Monitor DTM10  See page 50 For traceability management! Outputs torque value from a screwdriver (converted value)	Vacuum Sleeve DLS4000 series  See page 49 Select according to the screw shape	Vacuum pickup DLP6640  See page 49 For screw vacuum pickup *DLS4225/DLS4227 included	Vacuum pickup for automatic machine DLP6650 with flange coupling  See page 49
Torque Checker DLT1173A  For torque control of screwdrivers See page 46	Screw joint (with white rubber) DLW4540  For DLV04C SOFT fastening torque measurement See page 46	Screw joint (with black rubber) DLW4550  For DLV10C SOFT fastening torque measurement See page 46	Screw joint (with metal washer) DLW4560  For HARD fastening torque measurement of both DLV04C/DLV10C See page 46	Screw Vacuum Pump DLP2530 (100 V AC) DLP2570 (230 V AC)  See page 51 Connect the tube to the vacuum pickup port. The vacuum will pick up the screw.
Flange coupling (for automatic machine) DLW9015  For mounting on automated screw fastening machines See page 53	Connection Cord 2 m DLW9075  Standard accessory of screwdrivers Connects controller and screwdriver	Extension Cord 3 m DLW9300  Extends cord length between controller and screwdriver	Floating Unit DLW9510  For mounting on automated screw fastening machines	L Type Flange Attachment DLW9520  For mounting on automated screw fastening machines



S Series (Variable speed type)

Model **DLV30S/DLV45S/DLV70S**

Features

- Built-in brushless motor
- Automatic speed control function
- Built-in screw counting function
- ESD (electrostatic discharge) protection structure
- Settings can be configured with the optional Remote Controller

This screwdriver can deal with various fastening conditions.

Built-in screw counting function saves space!
 9 speed setting available.
 Wide range of specifications meet various screw fastening conditions.

Torque range 0.4 to 7.0 Nm
 [3.5 to 62.0 lbf-in]

Lever Start / Push to Start



Built-in Automatic Speed Control Function

Low speed starting reduces the problems at start.

<Step 1>

High speed feeding at middle improves efficiency and quality of screw fastening work.

<Step 2>

Low speed fastening at finish reduces the problems at finish.

<Step 3>

Built-in the Functions of Screw Fastening Counter

- Screw count setting
- Fastening time setting, and fastening time measurement



Main LED mounted on the screwdriver

LEDs and Setting Buttons on the Screwdriver



Specifications

		Low Speed	Standard	High Speed	Low Speed	Standard	Low Speed
Model	Bit	DLV30S06L-AY K	DLV30S12L-AY K	DLV30S20L-AY K	DLV45S06L-AY K	DLV45S12L-AY K	DLV70S06L-AY K
	Lever Start	DLV30S06P-AY K	DLV30S12P-AY K	DLV30S20P-AY K	DLV45S06P-AY K	DLV45S12P-AY K	DLV70S06P-AY K
Power Source		DEA0151N-AZ or DEA0241N-AZ		DEA0241N-AZ	DEA0151N-AZ or DEA0241N-AZ		DEA0241N-AZ
Torque Adjustment		Stepless					
Torque (Nm [lbf-in])	Low Torque Spring*1	0.4 to 1.6 [3.5 to 14.2]		2.0 to 4.5 [17.7 to 39.8]		3.8 to 7.0 [33.6 to 62.0]	
	High Torque Spring*2	1.2 to 3.0 [10.6 to 26.6]					
Free Speed (min ⁻¹)	For the details, see separate setting range of speed and torque.						
Speed Level	Lv1(Min. Speed) to Lv9(Max. Speed)						
Power Consumption (W)	44						
Screw Size (mm)	Machine Screw	2.6 to 5.0		4.5 to 6.0		5.0 to 8.0	
	Tapping Screw	2.5 to 4.0		4.0 to 5.0		4.5 to 6.0	
Mass (g [lbs])	710 [1.57]		860 [1.90] (with pistol grip)				
Rated Operation	ON: 0.5 seconds / OFF: 3.5 seconds						
Bit Grounding	Equipped as standard						
Standard Accessories	<ul style="list-style-type: none"> • Bit NK35(No.2 × 7 × 75): 1 pc. • Suspension Bail: 1 pc. • Low Torque Spring: 1 pc. • Connection Cord 1.5 m (DLW9073): 1 pc. • Torque Adjustment Ring Cover (DLW5203) 				<ul style="list-style-type: none"> • Bit NK35(No.2 × 7 × 75): 1 pc. • Suspension Bail: 1 pc. • Connection Cord 1.5 m (DLW9073): 1 pc. • Pistol Grip (DLW2300ESD): 1 pc. • Torque Adjustment Ring Cover (DLW5202) 		
Input/Output Signal Type	PNP						

Power Supply	Model	DEA0151N-AZ	DEA0241N-AZ
Power Source	100 - 240 V AC, 50/60 Hz, 60 W		
Output Voltage	40 V DC		
Maximum Rated Power (W)	150	240	
Mass (kg)	0.56	0.9	
Power Cord 2m (Optional)*3	DLW9220 / DLW9240 / DLW9250		

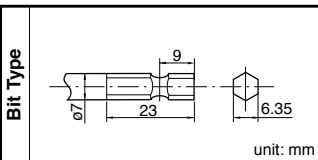

*1: Standard Accessory
 *2: Installed
 *3: The power cord is sold separately. Ask us for the required power cord when ordering.

Please contact us for 5 mm bit type

Torque Diagrams
(for reference)

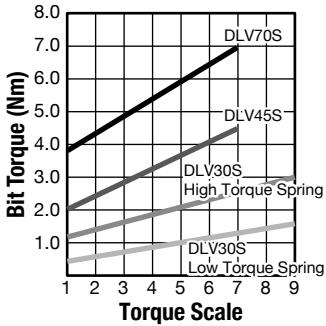

Setting with the Remote Controller

Infrared data transmission and the LCD display shorten the setting time. Simultaneous setting of multiple screwdrivers with the Remote Controller. *The Remote Controller is available as an option.

Key Lock Command

The Remote Controller can transmit the key lock command to a screwdriver. The key lock command prevents accidental button operation on the screwdriver.



Setting Range of Speed and Torque (for reference only)

		DLV30S06	DLV45S06	DLV70S06			DLV30S12	DLV45S12			DLV30S20
Speed Level	Speed (min ⁻¹)	Torque (Nm [lbf-in])			Speed Level	Speed (min ⁻¹)	Torque (Nm [lbf-in])		Speed Level	Speed (min ⁻¹)	Torque (Nm [lbf-in])
Lv1	160	0.4 to 1.3 [3.5 to 11.5]	Do not use	Do not use	Lv1	300	0.4 to 0.6 [3.5 to 5.3]	Do not use	Lv1	500	0.4 [3.5]
Lv2	220	0.4 to 2.0 [3.5 to 17.7]	2.0 to 2.4 [17.7 to 21.2]	Do not use	Lv2	420	0.4 to 1.2 [3.5 to 10.6]	Do not use	Lv2	690	0.4 to 0.8 [3.5 to 7.0]
Lv3	280	0.4 to 2.7 [3.5 to 23.9]	2.0 to 3.5 [17.7 to 30.9]	3.8 [33.6]	Lv3	530	0.4 to 1.8 [3.5 to 15.9]	2.0 [17.7]	Lv3	880	0.4 to 1.2 [3.5 to 10.6]
Lv4	340	0.4 to 3.0 [3.5 to 26.6]	2.0 to 4.5 [17.7 to 39.8]	3.8 to 4.6 [33.6 to 40.7]	Lv4	640	0.4 to 2.4 [3.5 to 21.2]	2.0 to 2.6 [17.7 to 23.0]	Lv4	1,060	0.4 to 1.6 [3.5 to 14.1]
Lv5	410	0.4 to 3.0 [3.5 to 26.6]	2.0 to 4.5 [17.7 to 39.8]	3.8 to 5.4 [33.6 to 47.8]	Lv5	750	0.4 to 3.0 [3.5 to 26.6]	2.0 to 3.2 [17.7 to 28.3]	Lv5	1,250	0.4 to 2.0 [3.5 to 17.7]
Lv6	470	0.4 to 3.0 [3.5 to 26.6]	2.0 to 4.5 [17.7 to 39.8]	3.8 to 6.2 [33.6 to 54.9]	Lv6	860	0.4 to 3.0 [3.5 to 26.6]	2.0 to 3.8 [17.7 to 33.6]	Lv6	1,440	0.4 to 2.4 [3.5 to 21.2]
Lv7	530	0.4 to 3.0 [3.5 to 26.6]	2.0 to 4.5 [17.7 to 39.8]	3.8 to 7.0 [33.6 to 62.0]	Lv7	980	0.4 to 3.0 [3.5 to 26.6]	2.0 to 4.4 [17.7 to 38.9]	Lv7	1,630	0.4 to 2.8 [3.5 to 24.7]
Lv8	590	0.4 to 3.0 [3.5 to 26.6]	2.0 to 4.5 [17.7 to 39.8]	3.8 to 7.0 [33.6 to 62.0]	Lv8	1,090	0.4 to 3.0 [3.5 to 26.6]	2.0 to 4.5 [17.7 to 39.8]	Lv8	1,810	0.4 to 3.0 [3.5 to 26.6]
Lv9	650	0.4 to 3.0 [3.5 to 26.6]	2.0 to 4.5 [17.7 to 39.8]	3.8 to 7.0 [33.6 to 62.0]	Lv9	1,200	0.4 to 3.0 [3.5 to 26.6]	2.0 to 4.5 [17.7 to 39.8]	Lv9	2,000	0.4 to 3.0 [3.5 to 26.6]

*Speed and torque are for reference only. The actual values depend on the materials to be fastened and size of screws. The values are not guaranteed.

Up to eight types of motion setting or up to 8 channels can be saved in the screwdriver

Eleven functions in motion setting can be saved in each channel.

Example of motion setting

		Channel				
		C1	C2	C3	...	C8
Motion setting	1 : Number of screw fastening	2 pieces	3 pieces	1 piece		4 pieces
	2 : Speed level at start	Level 2	Level 1	Level 1		Level 2
	3 : Rotation time at start	0.20 sec.	0.30 sec.	0.30 sec.		0.20 sec.
	4 : Speed level at middle	Level 7	Level 9	Level 9		Level 9
	5 : Rotation time at middle	0.30 sec.	0.50 sec.	3.0 sec.		7.5 sec.
	6 : Speed level at finish	Level 2	Level 1	Level 1		Level 2
	7 : Min. screw fastening time	0.60 sec.	0.80 sec.	3.5 sec.		8.0 sec.
	8 : Max. screw fastening time	1.0 sec.	1.2 sec.	4.0 sec.		9.0 sec.
	9 : Auto reverse mode setting	OFF	OFF	Reverse after torque-up		Reverse after reaching the min. screw fastening time
	10 : Reverse rotation speed level	—	—	Level 2		Level 1
	11 : Reverse rotation time	—	—	0.20 sec.		0.30 sec.

Automatic Channel Switching

Channel can be switched automatically if channel switching order is preset.

*Setting with the Remote Controller is required.

Example : Channel switching is set to C3 » C1 » C2

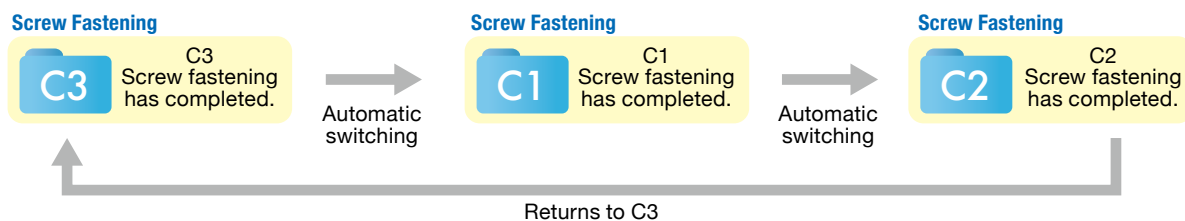



Setting of automatic channel switching pattern

Up to four automatic channel switching patterns can be set with an external signal.

*Setting with the Remote Controller is required.

Example of setting : Installation of the workpiece detection sensors A and B connected to the external signal connector.

Automatic channel switching is set to C2 » C1 on the side of the workpiece detection sensor A.
Automatic channel switching is set to C3 » C1 » C2 on the side of the workpiece detection sensor B.

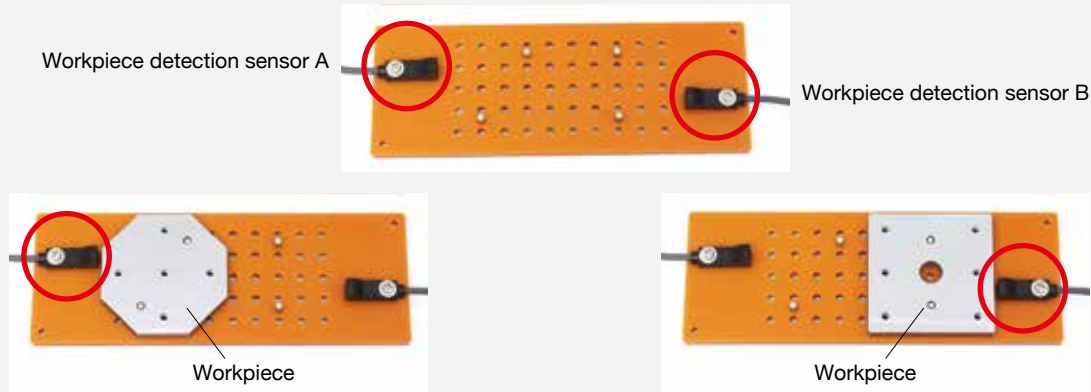

When the workpiece detection sensor A detects a workpiece, the preset automatic channel will be invoked.



When the workpiece detection sensor B detects a workpiece, the preset automatic channel will be invoked.



Built-in Auto Reverse Mode

The screwdriver automatically reverses after torque-up or reaching the preset time.
Auto reverse mode can be used for temporarily fastening screws or verifying tapped holes.

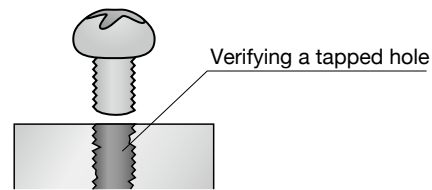
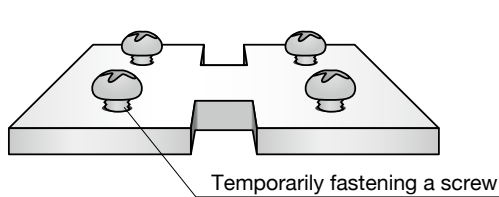

Equipped with the External Signal Connector

The screwdriver can input/output external signals through the external signal connector.







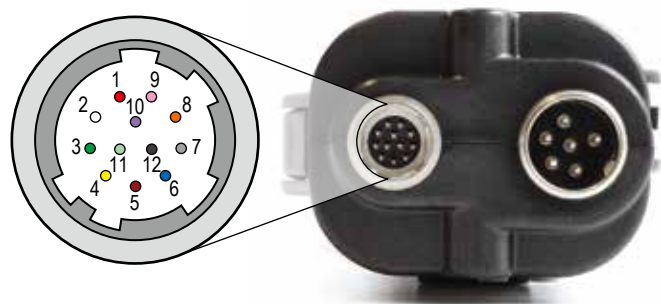











Pin No.	Lead wire color	Signal	Input / output
1	Red	+24 V DC power (supplied from outside)	
2	White	Workpiece Signal	Input
3	Green	Reset signal	Input
4	Yellow	LINK-IN	Input
		Forced stop signal	
5	Brown	OK Signal	Output
6	Blue	NG Signal	Output
7	Gray	LINK-OUT	Output
		Channel switching signal	
8	Orange	Torque-up (count) signal	Output
9	Peach	Channel A	Input
10	Purple	Channel B	Input
11	Yellow Green	Channel C	Input
12	Black	0 V DC	

Lead wire colors are the ones used in the optional signal cable ass'y DLW9090.

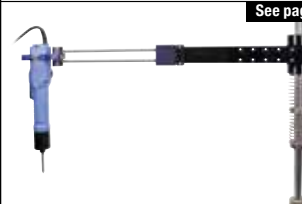
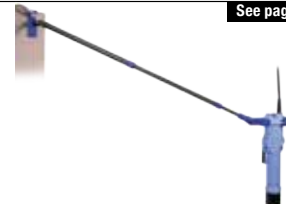
*Either Pin No.4 or 7 must be selected, but not both.
*Input / Output signal type is PNP.



Optional Accessories

Grounded 3-Prong Power Cord 2 m	Power Supply DEA0151N-AZ / DEA0241N-AZ	Remote Controller RC1000	Signal Cable Ass'y 3 m DLW9090
DLW9220 North America DLW9240 Europe DLW9250 UK	 *Power cord is not included	 For simultaneous setting of multiple screwdrivers	 For signal input/output
Connection Cord 1.5 m DLW9073	Relay Cord 0.1 m (To connect DLW9073 and DLW9073) DLW9074	Rubber Grip DRG1000 (Non-ESD)	Pistol Grip DLW2300ESD
Standard accessory of screwdrivers  Connects Power Supply and screwdriver	 To connect DLW9073 and DLW9073	 For anti-slip when fastening	See page 51 ESD Protection  Standard accessory of DLV45S/DLV70S For operator fatigue reduction, suitable for horizontal fastening
Torque Adjustment Ring Cover DLW5203	Torque Adjustment Ring Cover DLW5202	Sleeve for Vacuum Pickup DLS4000 Series	Vacuum Pickup DLP7401-K
 Standard accessory of DLV30S	 Standard accessory of DLV45S/DLV70S	See page 49  Select according to the screw shape	See page 49  For screw vacuum pickup *DLS4220/DLS4221 included
Torque Reaction Arm (TD06180)	Torque Reaction Arm DRA-SW-650 (Swing type)	Torque Reaction Arm DRA-SL-650 (Slide type)	Torque Reaction Arm DRA-TS-1000 (Telescope type)
See page 52  For reducing reaction force to an operator	See page 50  For reducing reaction force to an operator Vertical tightening to the workpiece improves quality of the work	See page 50  For reducing reaction force to an operator	See page 50  For reducing reaction force to an operator
Angle Attachment (For use with lever start type only) DLW9021	Diamond Shape Flange Coupling DLW9016	Flange Coupling DLW9018	Diamond Shape Flange Coupling DLW9017
See page 52  For fastening work at right angles *Use with an output torque of 2.0 Nm or less and a torque scale of 2 or more.	See page 54  For DLV30S For mounting on equipment or jigs	See page 54  For DLV45S/DLV70S For mounting on equipment or jigs	See page 54  For DLV45S/DLV70S For mounting on equipment or jigs
			See page 54  For DLV45S/DLV70S For mounting on equipment or jigs

Low Voltage (DC)

Brush motor **Brushless motor**

Miniature screw Precision screw **Machine screw**

2.6 to 8.0 mm

See page 55 for External Dimensions

Delvo Brushless Type



A Series (Low voltage, ESD type)

Model **DLV30A-AY/DLV45A-AY/DLV70A-AY**

Features

Eco-friendly electric screwdrivers with built-in brushless motors in a low voltage (DC) profile

- Torque range from 0.4 to 7.0 Nm
- Maximum free speeds of 650, 1200 or 2000 min⁻¹
- Both the Lever Start and Push to Start type models are available
- Equipped with a torque adjustment ring cover
- Design conforms to the RoHS Directive and thus appeals to the environmentally conscious user
- Easily detachable Pistol Grip DLW2300 ESD (TD01965) comes with the unit as a standard accessory (DLV45A/DLV70A)
- ESD (electrostatic discharge) protection structure



DLV30A06L DLV30A12L DLV70A06L

DEA0151N-AZ DEA0241N-AZ

Specifications

		Low Speed	Standard	High Speed	Low Speed	Standard	Low Speed	
Electric Screwdriver	Model	DLV30A06L-AY : K	DLV30A12L-AY : K	DLV30A20L-AY : K	DLV45A06L-AY : K	DLV45A12L-AY : K	DLV70A06L-AY : K	
	Bit	Lever Start	DLV30A12L-AY : K	DLV30A20P-AY : K	DLV45A06P-AY : K	DLV45A12P-AY : K	DLV70A06P-AY : K	
	Power Source	DEA0151N-AZ or DEA0241N-AZ		DEA0241N-AZ	DEA0151N-AZ or DEA0241N-AZ		DEA0241N-AZ	
	Torque Adjustment	Stepless						
	Torque (Nm [lbf-in])	Low Torque Spring*1	0.4 to 1.6 [3.5 to 14.2]			2.0 to 4.5 [17.7 to 39.8]		3.8 to 7.0 [33.6 to 62.0]
		High Torque Spring*2	1.2 to 3.0 [10.6 to 26.6]					
	Free Speed (min ⁻¹)	650	1200	2000	650	1200	650	
	Power Consumption (W)	44						
	Screw Size (mm)	Machine Screw	2.6 to 5.0			4.5 to 6.0		5.0 to 8.0
		Tapping Screw	2.5 to 4.0			4.0 to 5.0		4.5 to 6.0
Mass (g [lbs])	690 [1.52]			840 [1.85] (with Pistol Grip)				
Rated Operation	ON: 0.5 seconds / OFF: 3.5 seconds							
Bit Grounding	Equipped as standard							
Standard Accessories	• Bit NK35(No.2 × 7 × 75): 1 pc. • Low Torque Spring: 1 pc. • Bit NK35(No.2 × 7 × 75): 1 pc. • Connection Cord 1.5 m (DLW9073): 1 pc. • Suspension Bail: 1 pc. • Connection Cord 1.5 m (DLW9073): 1 pc. • Suspension Bail: 1 pc. • Pistol Grip (DLW2300ESD): 1 pc. • Torque Adjustment Ring Cover (DLW5203) • Torque Adjustment Ring Cover (DLW5202)							
Power Supply	Model	DEA0151N-AZ	DEA0241N-AZ					
	Power Source	100 - 240 V AC, 50/60 Hz						
	Output Voltage	40 V DC						
	Maximum Rated Power (W)	150	240					
	Mass (kg)	0.56	0.9					
Power Cord 2 m (Optional)*3	DLW9220 / DLW9240 / DLW9250							
			Bit Type			*1: Standard Accessory *2: Installed *3: The power cord is sold separately. Ask us for the required power cord when ordering.		

Please contact us for 5 mm bit type.

Torque Diagrams (for reference)

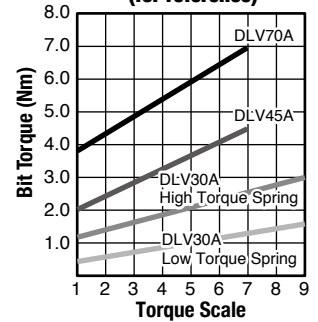

Optional Accessories

Grounded 3-Prong Power Cord 2 m DLW9220 North America DLW9240 Europe DLW9250 UK	Rubber Grip DRG1000 (Non-ESD) For anti-slip when fastening	Pistol Grip DLW2300 ESD ESD Protection Standard accessory of DLV45A/DLV70A For operator fatigue reduction, suitable for horizontal fastening	Torque Adjustment Ring Cover DLW5203 / DLW5202 Standard accessory of DLV30A Standard accessory of DLV45A/DLV70A
Angle Attachment (For use with lever start type only) DLW9021 For fastening work at right angles *Use with an output torque of 2.0 Nm or less and a torque scale of 2 or more	Torque Reaction Arm (TD06180) For reducing reaction force to an operator	Torque Reaction Arm DRA-SW-650 (Swing type) For reducing reaction force to an operator Vertical tightening to the workpiece improves quality of the work	Torque Reaction Arm DRA-SL-650 (Slide type) For reducing reaction force to an operator
Connection Cord 1.5 m DLW9073 Standard accessory of screwdrivers Connects Power Supply and screwdriver	Vacuum Sleeve DLS4000 series Select according to the screw shape	Vacuum Pickup DLP7401-K For screw vacuum pickup *DLS4220/DLS4221 included	Diamond Shape Flange Coupling DLW9016 For DLV30A For mounting on equipment or jigs
			Flange Coupling DLW9018 For mounting on equipment or jigs
			Diamond Shape Flange Coupling DLW9017 For mounting on equipment or jigs
			Flange Coupling DLW9019 For mounting on equipment or jigs

Low Voltage (DC)

Brush motor **Brushless motor**

Miniature screw Precision screw **Machine screw**

2.6 to 8.0 mm

See page 55 for External Dimensions

Delvo Brushless Type



DLV30A06P DLV30A12L DLV30A20P DLV45A06L DLV45A12L DLV45A12P DLV70A06L DLV70A06P

A Series (Low voltage, Non-ESD type)

Model **DLV30A-AS/DLV45A-AS/DLV70A-AS**

Features

- Incorporates long-life 40 V DC Brushless Motors
- Three series of screwdrivers: DLV30A-AS/DLV45A-AS/DLV70A-AS can be operated by one standard controller or counter. The dedicated controller or counter can be selected according to the application
- Wide torque range from 0.4 to 7.0 Nm
- Maximum free speeds of 650, 1200 or 2000 min⁻¹
- Robust and high durability realized by new body design using high strength plastic
- Good for left-handed operators who find built-in counter models difficult to use

Specifications

		Low Speed	Medium Speed	High Speed	Low Speed	Medium Speed	Low Speed	
Electric Screwdriver	Model	Lever Start DLV30A06L-AS : K DLV30A12L-AS : K DLV30A20L-AS : K	Push to Start DLV30A12P-AS : K DLV30A20P-AS : K	DLV45A06L-AS : K DLV45A12L-AS : K DLV45A12P-AS : K	DLV70A06L-AS : K DLV70A06P-AS : K	DLC70S-WGB or DLR70S-WGB		
	Power Source							
	Torque Adjustment	Stepless						
	Torque(Nm [lbf-in])	Low Torque Spring (Standard Accessory)	0.4 to 1.6 [3.5 to 14.2]			2.0 to 4.5 [17.7 to 39.8]		3.8 to 7.0 [33.6 to 62.0]
		High Torque Spring (Built-in)	1.2 to 3.0 [10.6 to 26.6]					
	Adjustable Speed Range* (min ⁻¹)	390 to 650	720 to 1200	1200 to 2000	390 to 650	720 to 1200	390 to 650	
	Adjustable Soft Start Time* (sec)	0 to 2						
	Free Speed at Soft Start* (min ⁻¹)	260	480	800	260	480	260	
	Power Consumption (W)	44						
	Screw Size (mm)	Machine Screw	2.6 to 5.0			4.5 to 6.0		5.0 to 8.0
Tapping Screw (g [lbs])		2.5 to 4.0			4.0 to 5.0		4.5 to 6.0	
Mass	720 [1.59]			870 [1.92] (with Pistol Grip)				
Bit Type								
Cord Length (m)	3 (with connector)							
Rated Operation	ON: 0.5 seconds / OFF: 3.5 seconds							
Bit Grounding	Equipped as standard							
Standard Accessories	<ul style="list-style-type: none"> • Bit No.2 x 7 x 75 • Suspension Bail 		<ul style="list-style-type: none"> • Low Torque Spring • Torque Adjustment Ring Cover DLW5201 		<ul style="list-style-type: none"> • Bit No.2 x 7 x 75 • Suspension Bail 		<ul style="list-style-type: none"> • Pistol Grip(DLV2300) • Torque Adjustment Ring Cover DLW5202 	

*Values are obtainable in combination with control unit DLR70S-WGB or DLC70S-WGB.

Torque Diagrams (for reference)

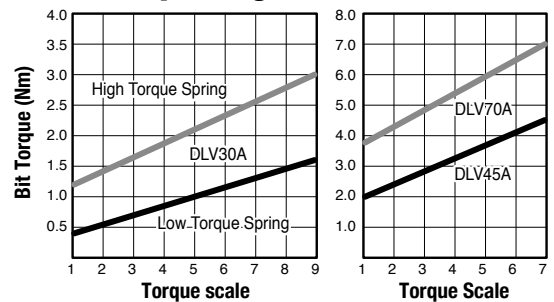

Optional Accessories

Torque Adjustment Ring Cover DLW5201 (Non-ESD) Standard accessory of DLV30A	DLW5202 Standard accessory of DLV45A/DLV70A	Rubber Grip DRG1000 (Non-ESD) For anti-slip when fastening	Pistol Grip DLW2300 Standard accessory of DLV45A/DLV70A For operator fatigue reduction, suitable for horizontal fastening
Torque Reaction Arm (TD06180) For reducing reaction force to an operator	Torque Reaction Arm DRA-SW-650 (Swing type) For reducing reaction force to an operator. Vertical tightening to the workpiece improves quality of the work	Torque Reaction Arm DRA-SL-650 (Slide type) For reducing reaction force to an operator	Torque Reaction Arm DRA-TS-1000 (Telescope type) For reducing reaction force to an operator
Angle Attachment (for use with lever start type only) DLW9021 For fastening work at right angles *Use with an output torque of 2.0 Nm or less and a torque scale of 2 or more	Sleeve for Vacuum Pickup DLS4000 Series Select according to the screw shape	Vacuum Pickup DLP7401-K For screw vacuum pickup *DLS4220/DLS4221 included	Diamond Shape Flange Coupling DLW9016 For DLV30A For mounting on equipment or jigs
			Flange Coupling DLW9018 For mounting on equipment or jigs
			Diamond Shape Flange Coupling DLW9017 For mounting on equipment or jigs
			Flange Coupling DLW9019 For mounting on equipment or jigs

See page 56 for External Dimensions

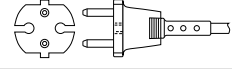

Specifications

Model	DLC70S-WGB
Features	With speed control and soft start function
Power Source	100 - 240 V AC, 50/60 Hz
Output Voltage	40 V DC
Signal Output(Relay contact)	Start, Torque up, Reverse (Dry contact)
Signal Input	Drive Stop Function (24 V DC Input Voltage needed)
Mass (g [lbs])	1800 [3.97]
Size W × L × H (mm [inch])	132 × 297 × 67 [5.20" × 11.70" × 2.64"]
Bit Grounding	Ready (With a 1M Ω resistor)
Plug shape	Europe 
Standard Accessories	Power cord (2 m): 1 pc. Rubber feet: 4 pcs. Fuse (5 A): 1 pc.

Controller

for DLV30A-AS/DLV45A-AS/DLV70A-AS

Model **DLC70S-WGB** 

Features

- "Soft Start" function: The slow startup prevents screw heads from possible damage caused by the disengaged bit
- "Stepless Speed Adjustment" function widens the speed range from 390 to 2000 min⁻¹ for various applications
- The controller outputs: Start, torque-up and reverse signal via a dry contact method. These signals can be used for counting up fastened screws and preventing screw fastening errors
- "Driver Lock" function: Applying 24 V DC to the designated terminals on the controller brings the screwdriver to an immediate stop in emergency cases

Installation

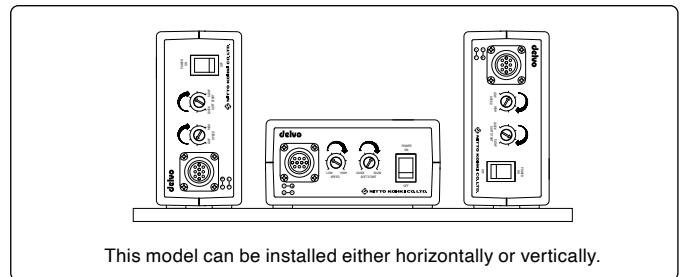

See page 56 for External Dimensions

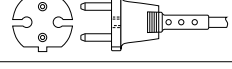

Specifications

Model	DLR70S-WGB
Power Source	100 - 240 V AC, 50/60Hz
Output Voltage	40 V DC
Speed Control Function	60 to 100%
Soft Start Function	0 to 2 sec.
Count	0 to 99
Allowable Number of Screw Fastening Programs	4
Counting Method	Count-up / Count-down
Count Correction Function	Count normal fastening only
Self Adjustable Timer Setting	0.01 to 0.99 sec.
OK Output Timer Setting	0 to 9.5 sec.
Count Back Function	ON / OFF
OK / NG Buzzer	ON / OFF
Input Signal(PNP)	WORK / RESET / LINK-IN / CH1 / CH2 / TORQUE CHECK
Output Signal(Relay contact)	OK / NG / LINK-OUT / TORQUE UP
Mass (g [lbs])	2100 [4.63]
Size W × L × H (mm [inch])	117 × 325 × 76 [4.61" × 12.80" × 2.99"]
Bit Grounding	Ready (With a 1 MΩ resistor)
Plug shape	Europe 
Standard Accessories	Power cord (2 m): 1 pc. Fuse (5 A): 1pc.

Screw Fastening Counter

for DLV30A-AS/DLV45A-AS/DLV70A-AS

Model **DLR70S-WGB** 

Features

- Equipped with "Stepless Speed Adjustment" function and "Soft Start" function
- "Count Correction" function does not count fastening errors such as elevated screws or double fastening
- "Count Back (Count Return)" function: When a screw is loosened, a reverse signal output from the electric screwdriver reverses the count by one
- Up to four different screw fastening settings can be saved in the internal memory for a wide variety of assembly work
- "Link Connection" function: Up to 10 screwdriver/controller sets can be connected in series
- Good for left-handed operators who find built-in counter models difficult to use



Transformerless (AC)
 Brush motor **Brushless motor**
 Miniature screw Precision screw **Machine screw**
2.6 to 8.0 mm

See page 56 for External Dimensions

Delvo Brushless Type



DLV30A06P-AB DLV30A12L-AB DLV30A20P-AB DLV45A12L-AB



DLV30A06P-SP DLV30A12L-SP DLV30A20P-SP DLV45A06L-SP/DLV45A12L-SP/DLV70A06L-SP

A Series (Transformerless type)

Model **DLV30A-AB/DLV45A-AB** **DLV70A-AB**

Features

Eco-friendly electric screwdrivers with built-in brushless motors in a transformerless profile

- Torque range from 0.4 to 7.0 Nm
- Maximum free speeds of 650, 1200 or 2000 min⁻¹
- Both the Lever Start and Push to Start type models are available
- Equipped with a torque adjustment ring cover
- Design conforms to the RoHS Directive and thus appeals to the environmentally conscious user
- Easily detachable Pistol Grip DLW2300 (TD00335) comes with the unit as a standard accessory (DLV45A/DLV70A)

A Series (Transformerless, Signal output type)

Model **DLV30A-SP(AB)/DLV45A-SP(AB)** **DLV70A-SP(AB)**

- In addition to the above features of A series (Transformerless-type), SP Type (made-to-order) can output torque-up signal.

Specifications

		Low Speed	Standard	High Speed	Low Speed	Standard	Low Speed
Model (Standard)	Bit	DLV30A06L-AB : K	DLV30A12L-AB : K	DLV30A20L-AB : K	DLV45A06L-AB : K	DLV45A12L-AB : K	DLV70A06L-AB : K
	Bit	DLV30A06P-AB : K	DLV30A12P-AB : K	DLV30A20P-AB : K	DLV45A06P-AB : K	DLV45A12P-AB : K	DLV70A06P-AB : K
Model (Made-to-order)*1	Bit	DLV30A06L-SP(AB) : K	DLV30A12L-SP(AB) : K	DLV30A20L-SP(AB) : K	DLV45A06L-SP(AB) : K	DLV45A12L-SP(AB) : K	DLV70A06L-SP(AB) : K
	Bit	DLV30A06P-SP(AB) : K	DLV30A12P-SP(AB) : K	DLV30A20P-SP(AB) : K	DLV45A06P-SP(AB) : K	DLV45A12P-SP(AB) : K	DLV70A06P-SP(AB) : K
Power Source		230 V AC, 50/60 Hz					
Torque Adjustment		Stepless					
Torque (Nm [lbf-in])	Low Torque Spring ^{*2}	0.4 to 1.6 [3.5 to 14.2]			2.0 to 4.5 [17.7 to 39.8]		3.8 to 7.0 [33.6 to 62.0]
	High Torque Spring ^{*3}	1.2 to 3.0 [10.6 to 26.6]					
Free Speed (min ⁻¹)		650	1200	2000	650	1200	650
Power Consumption (W)		Approx. 45					
Screw Size (mm)	Machine Screw	2.6 to 5.0			4.5 to 6.0		5.0 to 8.0
	Tapping Screw	2.5 to 4.0			4.0 to 5.0		4.5 to 6.0
Mass (g [lbs])		700 [1.54]			870 [1.92] (with Pistol Grip)		
Cord length (m)		3					
Rated Operation		ON: 0.5 seconds / OFF: 3.5 seconds					
Bit Grounding		Equipped as standard					
Standard Accessories		• Bit NK35(No.2 × 7 × 75): 1 pc. • Suspension Bail: 1 pc. • Low Torque Spring: 1 pc. • Torque Adjustment Ring Cover DLW5201			• Bit NK35(No.2 × 7 × 75): 1 pc. • Suspension Bail: 1 pc. • Pistol Grip (DLW2300) • Torque Adjustment Ring Cover DLW5202		

Bit Type		Europe
	unit: mm	

Please contact us for 5 mm bit type.

*1: SP Type (made-to-order) can output torque-up signal
 *2: Standard Accessory
 *3: Installed

Torque Diagrams (for reference)

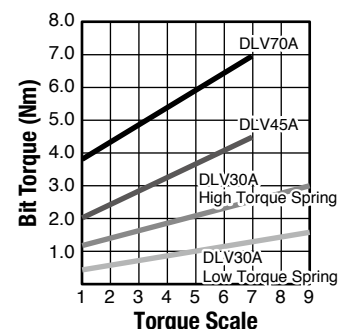

Signal specifications (SP type)

Example wiring of output signals

Output signal	Signal cable wiring color
Start	Green
Torque-up	White
Reverse	Yellow
80 V DC or less	Black

Output signal specification

Signal output	Open collector
Rated voltage	80 V DC or less
Rated current	Maximum 20 mA per output

Output signal timing chart

	Signal cable wiring color	Signal timing
Start switch	—	Forward Reverse
Start	Green	
Torque-up	White	Torque-up
Reverse	Yellow	

Internal circuit

Optional Accessories

Torque Adjustment Ring Cover		Sleeve for Vacuum Pickup DLS4000 Series	Vacuum Pickup DLP7401-K	Angle Attachment (For use with lever start type only) DLW9021	
DLW5201(Non-ESD)	DLW5202	See page 49	See page 49	See page 52	
Standard accessory of DLV30A	Standard accessory of DLV45A/DLV70A	Select according to the screw shape	For screw vacuum pickup *DLS4220/DLS4221 included	For fastening work at right angles *Use with an output torque of 2.0 Nm or less and a torque scale of 2 or more.	
Torque Reaction Arm (TD06180)	Torque Reaction Arm DRA-SW-650 (Swing type)	Torque Reaction Arm DRA-SL-650 (Slide type)	Torque Reaction Arm DRA-TS-1000 (Telescope type)		
See page 52	See page 50	See page 50	See page 50		
For reducing reaction force to an operator	For reducing reaction force to an operator Vertical tightening to the workpiece improves quality of the work		For reducing reaction force to an operator		
Rubber Grip DRG1000 (Non-ESD)	Pistol Grip DLW2300	Diamond Shape Flange Coupling	Flange Coupling	Diamond Shape Flange Coupling	Flange Coupling
DRG1000 (Non-ESD)	DLW2300	DLW9016	DLW9018	DLW9017	DLW9019
See page 51	See page 51	See page 54	See page 54	See page 54	See page 54
For anti-slip when fastening	Standard accessory of DLV45A/DLV70A For operator fatigue reduction, suitable for horizontal fastening	For DLV30A For mounting on equipment or jigs		For DLV45A/DLV70A For mounting on equipment or jigs	

Low Voltage (DC)

Brush motor **Brushless motor**

Miniature screw Precision screw Machine screw

1.0 to 4.0 mm

See page 57 for External Dimensions

Delvo Brushless Type

Lever Start Low Voltage Brushless Motor Grounded Bit Variable Speed Clutch Type ESD Protection BKE Models



DLV02SL-CKE DLV02SL-BKE
DLV12SL-CKE DLV12SL-BKE
DLV16SL-CKE DLV16SL-BKE

DLC16S

DLV02/DLV12/DLV16 Series

Features

Brushless motors are incorporated for maximum tool life

- Ergonomic grip offers greater operator comfort and increased maneuverability
- Grounded bit system standard
- Clear plastic torque adjustment cover provided as standard accessory (DLV02/DLV12/DLV16SL-CKE)
- ESD (electrostatic discharge) protection structure (DLV02/DLV12/DLV16SL-BKE)
- Compliant with CE standards
- Controllers feature an overload detection function. When an overload is detected, the controller stops the screwdriver. Operation can be resumed after the screwdriver is unloaded, and the lever released (DLC16S)
- Universal input voltage from 100 to 240 V AC for easy installation (DLC16S)
- Variable speed adjustment enables you to select optimum screw tightening speed (DLC16S)

Specifications

Model	Standard Type	DLV02SL-CKE	DLV12SL-CKE	DLV16SL-CKE
	ESD Protection Type	DLV02SL-BKE	DLV12SL-BKE	DLV16SL-BKE
Starting Method		Lever Start		
Power Source		From dedicated controller DLC16S-WGB		
Torque Adjustment		Stepless		
Torque	(Nm [lbf-in])	0.03 to 0.2 [0.3 to 1.8]	0.15 to 1.2 [1.3 to 10.6]	0.2 to 1.6 [1.8 to 14.2]
Free Speed	(min ⁻¹)	700 to 1000		
Power Consumption		48		
Screw Size	Machine Screw	1.0 to 2.2	1.4 to 3.0	2.2 to 4.0
	Tapping Screw	1.0 to 2.0	1.4 to 2.6	2.0 to 3.0
Mass		470 [1.04]		
Rated Operation		ON: 0.5 seconds / OFF: 3.5 seconds		
Bit Grounding		Equipped as standard		

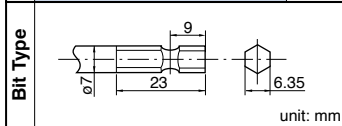

Model	DLC16S-WGB
Power Source	100 - 240 V AC, 50/60 Hz
Output Voltage	20 - 30 V DC
Function	Speed Control
Mass	(g [lbs]) 380 [0.84]
Power Cord Length	(m) 1.6

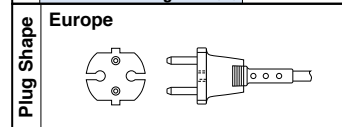

Standard Accessories

Model		DLV02	DLV12	DLV16
Bit NK36	No.0 × 3.8 × 50	1	-	-
	No.1 × 3.8 × 50	-	1	-
	No.2 × 4.5 × 50	-	1	1
Connection Cord 2.4 m		1		
Suspension Bail		1		

Optional Accessory

Connection Cord 2.4 m (TD07568)

Standard accessory of screwdrivers

Connects controller and screwdriver

*There are no vacuum pickup options available for this model.

Torque Diagrams (for reference)

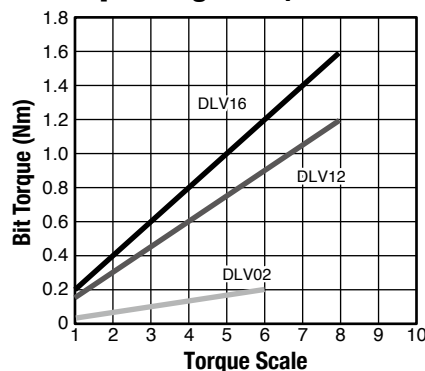

Low Voltage (DC)

Brush motor | Brushless motor

Miniature screw | Precision screw | Machine screw

1.0 to 2.6 mm

See page 57 for External Dimensions



DLV7419A
DLV7419HA
DLV7429A

DLV7400A Series

Features

The light and compact body reduces operator fatigue

- Reduces shock applied to workpieces when fastening screws
- ESD (electrostatic discharge) protection structure
- Lightweight (Standard type 230 g, Clean room type 275 g)
- The Clean Room Type complies with Class 3 Clean Room Rating
- The controller can adjust speed (Screw-fastening speed can be set to suit specific fastening conditions)
- The controller provides a soft start function
- The initial speed at screwdriver startup can therefore be slowed down, effectively preventing screw heads from being scratched
- The built-in coreless motor achieves reduced inertia
- Torque accuracy is within a top-ranked worldwide level (Based on measurements at our laboratory)
- Compliant with CE standards
- Use of the Screw Fastening Counter prevents human fastening errors and enhances accurate fastening control (No CE marking applied)
- Screw Fastening Counter Model DLR5640-WN works in conjunction with any dedicated SPC-type electric screwdrivers



DLV7410A DLC1110-GG/HE

DLV7419A
DLV7419HA
DLV7429A
DLV7410HA DLV7420A

Specifications

Model	Standard Type	DLV7410A-BME	DLV7410HA-BME	DLV7420A-BME	
	For Clean Room Use (with built-in vacuum pickup)	DLV7419A-BME	DLV7419HA-BME	DLV7429A-BME	
Electric Screwdriver	Starting Method	Lever Start			
	Power Source	From dedicated controller			
	Torque Adjustment	Stepless			
	Torque (Nm [lbf * in])	0.02 to 0.2 [0.2 to 1.8]		0.15 to 0.4 [1.3 to 3.5]	
	Free Speed (min ⁻¹)	500 to 750		700 to 1000	
	Power Consumption (W)	Approx. 10			
	Screw Size (mm)	Machine Screw	1.0 to 2.3		1.6 to 2.6
		Tapping Screw	1.0 to 2.0		1.4 to 2.3
	Mass (g [lbs])	Standard Type 230 [0.51] / Clean Room Type 275 [0.61]			
	Rated Operation	ON: 0.5 seconds / OFF: 3.5 seconds			
Bit Grounding	Equipped as standard				

unit: mm

Model	DLC1110-EN	DLC1110-FE	DLC1110-GE	DLC1110-GG	DLC1110-HE	DLC1213A-GGB*1	DLC1213A-HEB*1
Features	Non-CE	Non-CE	Non-CE	CE	CE	CE	Non-CE
Power Source	100 V AC, 50/60 Hz	115 V AC, 50/60 Hz	220 V AC, 50/60 Hz	230 V AC, 50/60 Hz	240 V AC, 50/60 Hz	230 V AC, 50/60 Hz	240 V AC, 50/60 Hz
Control Function	Soft Start, Speed Control, ESD Protected						
Output Voltage	40 V DC						
Mass (g [lbs])	900 [1.98]						2300 [5.07]
Plug Shape	USA	USA	UK	Europe	UK	Europe	UK
Power Cord Length (m)	2						

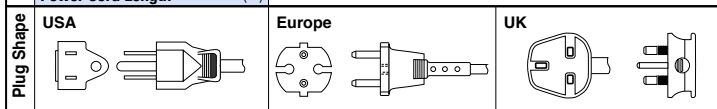

*1: An optional cord DLW9072 is required to connect DLC1213A-GGB or DLC1213A-HEB to the DLV7400A series.
Neither DLC1213A-GG nor DLC1213A-HE can be used with the DLV7400A series.

Model DLC1213A-GGB or DLC1213A-HEB + Cord DLW9072

Standard Accessories

Model		DLV7410A/DLV7410HA	DLV7420A	DLV7419A/DLV7419HA	DLV7429A
Bit NK4D	No.0 × 1.8 × 44	1	-	1	-
	No.0 × 2.5 × 44	1	1	1	1
	No.1 × 4 × 44	-	1	-	1
Connection Cord DLW9070 (1.5 m)		1	1	1	1
Low Torque Spring		1	-	1	-
Suspension Bail		1	1	1	1
Vacuum Sleeve	DLS2120	-	-	1	1
	DLS2124	-	-	1	1

Optional Accessories

<p>Sleeve for Vacuum Pickup DLS2000 Series</p> <p>Select according to the screw shape</p> <p>See page 49</p>	<p>Vacuum Pickup DLP5300</p> <p>For screw vacuum pickup *DLS2120/DLS2124 included</p> <p>See page 49</p>
--	--

Torque Diagrams (for reference)

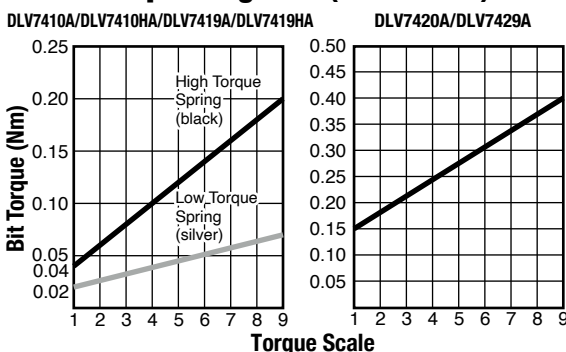

Shock Waveform Comparison between the 7400A series and our conventional models

Value of shock applied to the workpiece as measured using acceleration pickup.

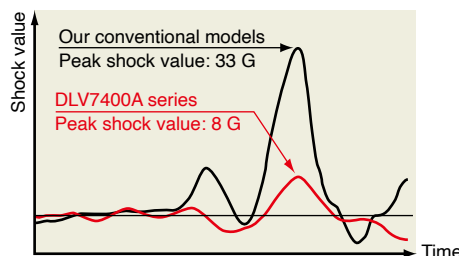

Torque Adjustment Ring Cover DLW5700

This minimizes tampering or accidental turning of the torque adjustment ring once the torque is set.

Low Voltage (DC)
 Brush motor | Brushless motor
 Miniature screw | Precision screw | Machine screw
 1.0 to 3.0 mm

See page 57 for External Dimensions

Delvo



DLV5700 Series Non-CE

Features

For quality improvement and productivity enhancement

- Grounded bit installation mechanism
- ESD (electrostatic discharge) protection structure
- Low-shock for tightening (30% less of standard models)
- Low swing bit mechanism
- Ergonomic design
- High-performance DC motor
- New clutch mechanism
- The rotation speed is variable according to the screw size and work environment.
- Soft start function prevents thread galling.
- By using a commercial counter or PLC with DLC0350, it is possible to control the numbers of screws tightened. (Torque-up signal output, start signal output)

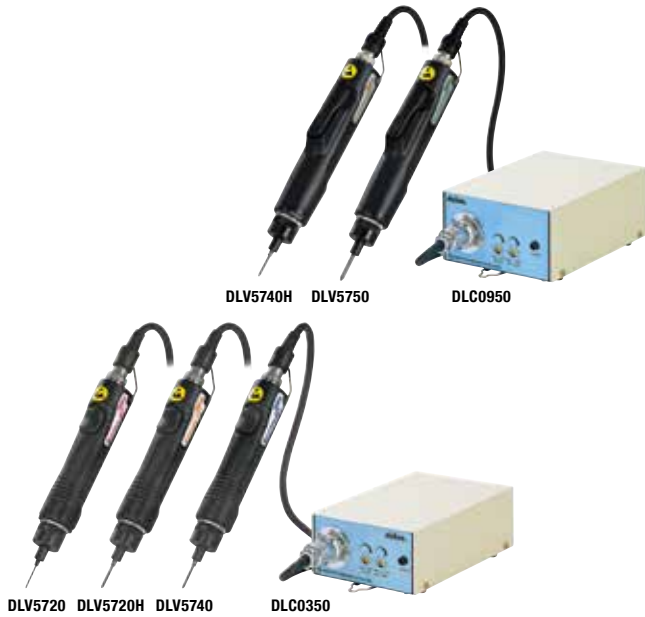

Specifications

Model	DLV5720	DLV5720H	DLV5740	DLV5740H	DLV5750
Starting Method	Lever Start				
Power Source	DLC0350			DLC0950	
Torque Adjustment	Stepless				
Torque (Nm [lbf·in])	0.02 to 0.2 [0.2 to 1.8]		0.15 to 0.4 [1.3 to 3.5]		0.1 to 0.55 [0.9 to 4.9]
Free Speed (min ⁻¹)	500 to 750	700 to 1000	450 to 600	1200 to 1800	670 to 1000
Power Consumption (W)	Approx. 10			Approx. 35	
Screw Size (mm)	Machine Screw	1.0 to 2.3		1.6 to 2.6	
	Tapping Screw	1.0 to 2.0		1.4 to 2.3	
Mass (g [lbs])	230 [0.51]			[0.66]	
Rated Operation	ON: 0.5 seconds / OFF: 3.5 seconds				
Bit Grounding	Equipped as standard				
Standard Accessories	<ul style="list-style-type: none"> • Bit NK4D(No.0 × 1.8 × 44): 1 pc. • Bit NK4D(No.0 × 2.5 × 44): 1 pc. • Connection Cord (1.5 m) DLW9081: 1 pc. • Suspension Bail: 1 pc. • Low Torque Spring: 1 pc. 		<ul style="list-style-type: none"> • Bit NK4D(No.0 × 2.5 × 44): 1 pc. • Bit NK4D(No.1 × 4 × 44): 1 pc. • Connection Cord (1.5 m) DLW9081: 1 pc. • Suspension Bail: 1 pc. 		

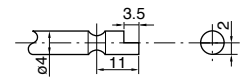

Model	DLC0350E	DLC0350F	DLC0350G	DLC0950E	DLC0950G
Power Source	100 V AC, 50/60 Hz	115 V AC, 50/60 Hz	230 V AC, 50/60 Hz	100 V AC, 50/60 Hz	230 V AC, 50/60 Hz
Plug Shape	USA 		UK 	USA 	
Mass (g [lbs])	900 [1.98]		2	1800 [3.97]	
Power Cord Length (m)	2				

Optional Accessories

Sleeve for Vacuum Pickup DLS2000 Series See page 49 Select according to the screw shape	Vacuum Pickup DLP5300 See page 49 For screw vacuum pickup *DLS2120/DLS2124 included
Torque Adjustment Ring Cover DLW5700 This minimizes tampering or accidental turning of the torque adjustment ring once the torque is set.	

Torque Diagrams (for reference)

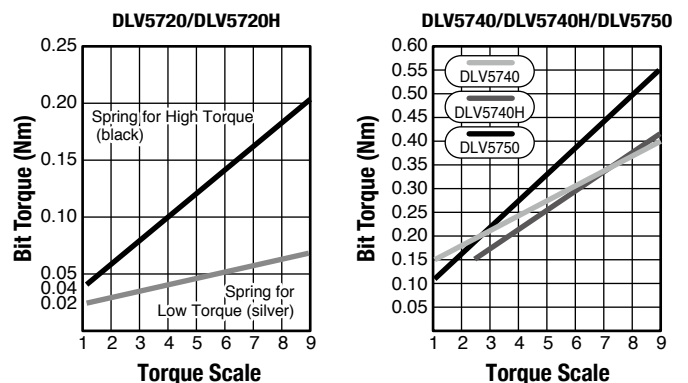

Low Voltage (DC)

Brush motor Brushless motor

Miniature screw Precision screw Machine screw

1.0 to 2.6 mm

See page 58 for External Dimensions

Lever Start Low Voltage Grounded Bit ESD Protection Variable Speed Soft Start Clutch Type

(When using DLV0350)

DLV5800U Series

DLV5800 Series Non-CE

Features

In response to the needs of cell production system, space-saving “delvo” screwdrivers are released. Controller is designed for emphasis on space-saving size and lightness.

- Clear disengagement of clutch (low-shock mechanism unavailable)
- Grounded bit installation mechanism
- ESD (electrostatic discharge) protection structure
- New lever is adopted
- Low swing bit mechanism
- Low voltage transformerless controller

[When using DLC0350]

- The rotation speed is variable according to the screw size and work environment.
- Soft start function prevents thread galling.
- By using a commercial counter or PLC with DLC0350, it is possible to control the numbers of screws tightened. (Torque-up signal output, start signal output)

*Please see page 58 for the internal circuit.



Specifications

Model	CE	DLV5820U	DLV5820HU	DLV5840U	Bit Type
	Non-CE	DLV5820	DLV5820H	DLV5840	
Starting Method	Lever Start				
Power Source	From dedicated controller				
Torque Adjustment	Stepless				
Torque (Nm [lbf.in])	0.02 to 0.2 [0.2 to 1.8]			0.15 to 0.4 [1.3 to 3.5]	
Free Speed (min ⁻¹)	750		1000		600
Power Consumption (W)	Approx. 10				
Screw Size (mm)	Machine Screw	1.0 to 2.3		1.6 to 2.6	
	Tapping Screw	1.0 to 2.0		1.4 to 2.3	
Mass (g [lbs])	230 [0.51]				
Cord Length (m)	1.5 (with connector)				
Rated Operation	ON: 0.5 seconds / OFF: 3.5 seconds				
Bit Grounding	Equipped as standard				
Standard Accessories	<ul style="list-style-type: none"> • Bit NK4D(No.0 × 1.8 × 44): 1 pc. • Bit NK4D(No.0 × 2.5 × 44): 1 pc. • Suspension Bail: 1 pc. • Connection Cord (1.5 m) DLW9081: 1 pc. • Low Torque Spring (Silver): 1 pc. 		<ul style="list-style-type: none"> • Bit NK4D(No.0 × 2.5 × 44): 1 pc. • Bit NK4D(No.1 × 4 × 44): 1 pc. • Suspension Bail: 1 pc. • Connection Cord (1.5 m) DLW9081: 1 pc. 		

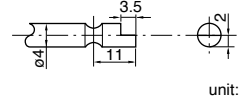

Model	DLC0250E	DLC0350E	DLC0350F	DLC0350G	DLC0350GG
Features	Non-CE				
Power Source	100 V AC, 50/60 Hz	100 V AC, 50/60 Hz	115 V AC, 50/60 Hz	230 V AC, 50/60 Hz	230 V AC, 50/60 Hz
Mass (g [lbs])	300 [0.66]		900 [1.98]		
Function	Soft Start	×		○	
	Variable Speed	×		○	
Output signal (NPN)	×		Start/Torque-up		
Plug Shape	USA		UK	Europe	
Power Cord Length (m)	2				

Optional Accessories

Sleeve for Vacuum Pickup DLS2000 Series	Vacuum Pickup DLP5300	Torque Adjustment Ring Cover DLW5700
See page 49	See page 49	
Select according to the screw shape	For screw vacuum pickup *DLS2120/DLS2124 included	This minimizes tampering or accidental turning of the torque adjustment ring once the torque is set.

Torque Diagrams (for reference)

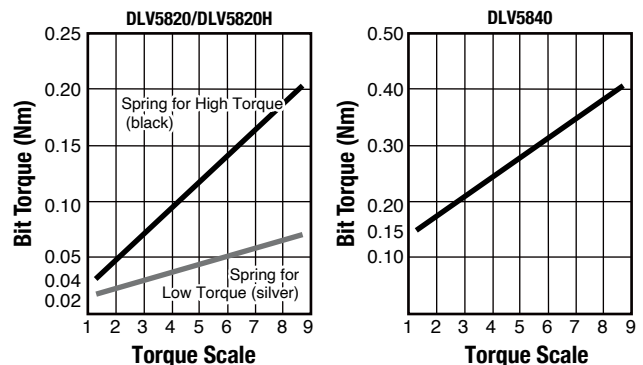

Low Voltage (DC)
 Brush motor | Brushless motor
 Miniature screw | Precision screw | Machine screw
 1.0 to 3.5 mm

See page 58 for External Dimensions

DLV7325
DLV7335

Lever Start | Low Voltage | Variable Speed | Soft Start | Clutch Type | Clean room adaption

Delvo



DLV7300 Series

Features

- The dedicated controller realizes high-accuracy screw tightening
- High repeatable torque accuracy
- The controller provides a soft start function. The initial speed at screwdriver startup can therefore be slowed down, effectively preventing screw heads from being scratched
- Variable speed adjustment enables to select optimum screw tightening speed
- DLV7325, DLV7335 meet Class 5* Clean Room standards

*Based on Nitto Kohki's standard of measurement

Specifications

Model	Bit Shank: \varnothing 4 mm Bit Shank: Hex. 6.35 mm	Standard			For Clean Room Use (with built-in vacuum pickup)	
		DLV7313-CME	DLV7323-CME	DLV7333-CME	DLV7325-CME*	DLV7335-CME*
Starting Method		Lever Start				
Power Source		From dedicated controller				
Torque Adjustment		Stepless				
Torque (Nm [lbf-in])		0.03 to 0.15 [0.3 to 1.3]	0.05 to 0.5 [0.4 to 4.4]	0.3 to 1.2 [2.7 to 10.6]	0.05 to 0.5 [0.4 to 4.4]	0.3 to 1.2 [2.7 to 10.6]
Free Speed (min ⁻¹)		700 to 1000		500 to 700	700 to 1000	500 to 700
Power Consumption (W)		Approx. 35				
Screw Size (mm)	Machine Screw	Up to 2.0	1.0 to 3.0	2.0 to 3.5	1.0 to 3.0	2.0 to 3.5
	Tapping Screw	Up to 1.7	1.2 to 2.6	2.0 to 3.0	1.2 to 2.6	2.0 to 3.0
Mass (g [lbs])		350 [0.77]			400 [0.88]	
Cord Length (m)		1.5 (with connector)				
Rated Operation		ON: 0.5 seconds / OFF: 3.5 seconds				

* Vacuum pump for suction of screw is available as option. See page 51 for details of the vacuum pump.

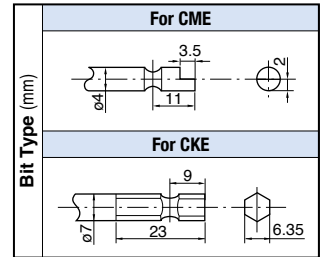

Model	DLC1213A-EN	DLC1213A-FE*	DLC1213A-GE	DLC1213A-GG	DLC1213A-GGU	DLC1213A-HE
Features	Non-CE	Non-CE	Non-CE	CE	CE	Non-CE
Power Source	100 V AC, 50/60 Hz	115 V AC, 50/60 Hz	220 V AC, 50/60 Hz	230 V AC, 50/60 Hz	230 V AC, 50/60 Hz	240 V AC, 50/60 Hz
Control Function	Soft start, Speed control					
Plug Shape	Asia	Asia	UK	Europe	UK	Without Plug
Mass (g [lbs])	2300 [5.07]					
Power Cord Length (m)	2					

* This model is made-to-order.

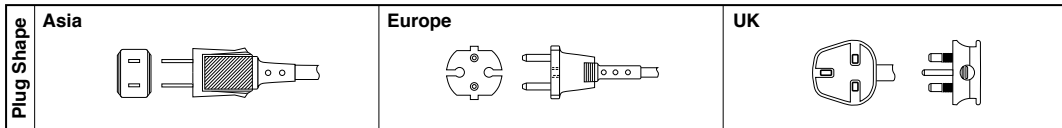

Torque Diagrams (for reference)

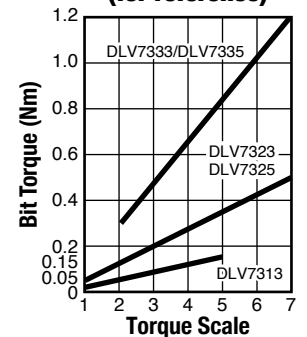

Standard Accessories

Model	DLV7313-CME	DLV7323-CME	DLV7333-CME	DLV7323/DLV7331/DLV7333-CKE	DLV7325-CME	DLV7335-CME	DLV7325/DLV7335-CKE
Bit	NK4D No.0 x 1.8 x 44	1	-	-	-	-	-
	NK4D No.0 x 2.5 x 44	1	1	-	1	-	-
	NK4D No.1 x 3 x 44	-	-	1	-	1	-
	NK4D No.1 x 4 x 44	-	1	-	-	1	-
	NK35 No.1 x 7 x 50	-	-	-	1	-	-
	NK4D No.2 x 4 x 44	-	-	1	-	-	1
	NK36 No.2 x 4.5 x 50	-	-	-	-	-	1
Vacuum Sleeve	DLS2124	-	-	-	1	-	-
	DLS2127	-	-	-	1	1	-
	DLS2130	-	-	-	1	1	-
	DLS2134	-	-	-	-	1	-
	DLS2135	-	-	-	-	-	1
Suspension Bail	1						

Optional Accessories

Torque Adjustment Ring Cover DLW5500	Extension Cord 3 m DLW9320	Vacuum Pickup DLP7100	Vacuum Pickup DLP7200	Vacuum Pickup DLP7300
For DLV7303 This minimizes tampering or accidental turning of the torque adjustment ring once the torque is set.	For 5P Extends cord length between controller and screwdriver	For DLV7313 *DLS2122/DLS2124/DLS2127 included	For DLV7323-CME/DLV7333-CME *DLS2122/DLS2124/DLS2127 included	For DLV7323-CKE/DLV7333-CKE *DLS2135 included

Low Voltage (DC)
 Brush motor / Brushless motor
 Miniature screw / Precision screw / Machine screw
 1.0 to 3.5 mm

See page 58 for External Dimensions



DLV7309



DLC1213A

Lever Start
 Low Voltage
 Grounded Bit
 ESD Protection
 Variable Speed
 Soft Start
 Clutch Type
 Low Shock
 Clean room adaption

DLV7319-BME
 DLV7329-BME
 DLV7339-BME
 DLV7349-BME

DLV7300-BME DLV7300-BKE Series

Features

Workpiece-conscious electric screwdrivers

- Statistic electricity build-up is prevented to protect workpieces from electrostatic discharge
- Minimal impact in screw tightening protects workpieces from damaging and enables stable screw tightening
- ESD (electrostatic discharge) protection structure
- DLV7319, DLV7329, DLV7339 and DLV7349 meet Class 5* or more Clean Room standards

*Based on Nitto Kohki's standard of measurement

Specifications

Model	Bit Shank: ϕ 4 mm Bit Shank: Hex. 6.35 mm	ESD		ESD / Low Shock / For Clean Room Use (with built-in vacuum pickup)			
		DLV7321-BME*1	DLV7331-BME*1	DLV7319-BME*1	DLV7329-BME*1	DLV7339-BME	DLV7349-BME*1
Starting Method		Lever Start					
Power Source		From dedicated controller					
Torque Adjustment		Stepless					
Torque (Nm [lbf-in])		0.05 to 0.50 [0.4 to 4.4]	0.30 to 1.20 [2.7 to 10.6]	0.20 to 0.40 [1.8 to 3.5]	0.25 to 0.55 [2.2 to 4.9]	0.45 to 0.95 [4.0 to 8.4]	0.55 to 1.20 [4.9 to 10.6]
Free Speed (min ⁻¹)		700 to 1000	500 to 700	700 to 1000		500 to 700	
Power Consumption (W)		Approx. 35					
Screw Size (mm)		Machine Screw 1.0 to 3.0	2.0 to 3.5	2.0 to 3.0		3.0 to 3.5	
		Tapping Screw 1.2 to 2.6	2.0 to 3.0	2.0 to 2.6		2.6 to 3.0	
Mass (g [lbs])		350 [0.77]			400 [0.88]		
Cord Length (m)		2 (with connector)					
Rated Operation		ON: 0.5 seconds / OFF: 3.5 seconds					
Bit Grounding		Equipped as standard					

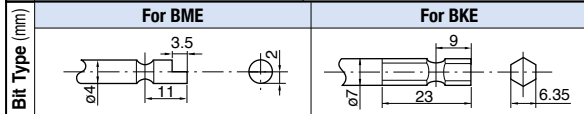

*1: These models are made-to-order.

Model	DLC1213A-ENB	DLC1213A-FEB*2	DLC1213A-GGB	DLC1213A-HEB
Features	Non-CE	Non-CE	CE	Non-CE
Power Source	100 V AC, 50/60 Hz	115 V AC, 50/60 Hz	230 V AC, 50/60 Hz	240 V AC, 50/60 Hz
Control Function	Grounding, Soft Start, Speed Control			
Plug Shape	USA	USA	Europe	UK
Mass (g [lbs])	2300 [5.07]			
Power Cord Length (m)	2			

*2: This model is made-to-order.

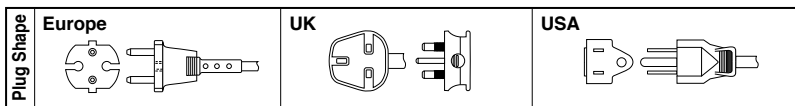

ESD protection measure

Measurement Point	Conventional Product	DLV7300-B□E	
		B	E
Handle	Static Electricity (V)	350	5
	Surface Resistance (Ω)	more than 10^{13}	10^4
Lever Switch	Static Electricity (V)	350	2
	Surface Resistance (Ω)	more than 10^{13}	10^4
Forward/Reverse Switch	Static Electricity (V)	25	2
	Surface Resistance (Ω)	more than 10^{13}	10^{10}
Power Cable	Static Electricity (V)	110	5
	Surface Resistance (Ω)	more than 10^{13}	10^{10}

Part	Material
Handle Lever Switch	Synthetic resin with carbon fiber
Power Cable	Anti-static material

*Measurement conditions (Temperature: 22°C Humidity: 66%)

(1) Static electricity

- Earth the measurement equipment and measuring person.
- Grip the screwdriver five times using Ansel Edmont electronic control glove.
- Turn on the switch of the screwdriver.
- Measure each part of the screwdriver using electronic measurement equipment manufactured by Shishido electrostatic Ltd.

(2) Surface resistance

- Measure using Simco Japan surface resistivity measurement equipment.

Standard Accessories

Model	DLV7319-BME DLV7329-BME	DLV7339-BME DLV7349-BME	DLV7321-BME	DLV7331-BME	DLV7321-BKE DLV7331-BKE	
Bit	NK4D No.0 \times 2.5 \times 44	-	1	-	-	
	NK4D No.1 \times 3 \times 44	1	-	1	-	
	NK4D No.1 \times 4 \times 44	1	-	1	-	
	NK35 No.1 \times 7 \times 50	-	-	-	-	1
	NK4D No.2 \times 4 \times 44	-	1	-	1	-
	NK35 No.2 \times 7 \times 50	-	-	-	-	1
Vacuum Sleeve	DLS2124	1	-	-	-	
	DLS2127	1	1	-	-	
	DLS2130	1	1	-	-	
	DLS2134	-	1	-	-	
Suspension Bail	1					

Optional Accessories

Extension Cord 2m DLW9330	Torque Adjustment Ring Cover DLW5300	Torque Adjustment Ring Cover DLW5400
For 6P Extends cord length between controller and screwdriver	For DLV7321-BME/DLV7331-BME	For DLV7321-BKE/DLV7331-BKE

Torque Diagrams (for reference)

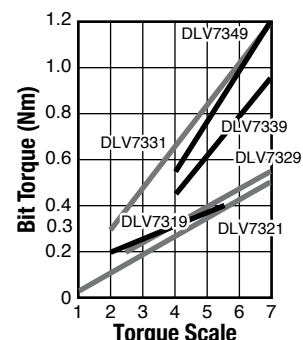

Low Voltage (DC)
 Brush motor | Brushless motor
 Miniature screw | Precision screw | Machine screw
 2.6 to 6.0 mm

See page 59 for External Dimensions

Lever Start | Push to Start | Low Voltage | Clutch Type | ESD Protection | BKE Models

DLV7500 DLV8500 Series

Features

Low vibration, low noise, and easy gripping in a compact design

- The easily visible torque reach light goes on when the set torque is reached
- The combination of an advanced clutch design and the auto-stop circuit assures torque accuracy
- The long life motor with a yoke made of advanced materials further assures a long service life
- Compliant with CE standard
- ESD (electrostatic discharge) protection structure (DLV7500-BKE/DLV8500-BKE)



Specifications

		Standard		High Torque	Standard		High Torque		
Electric Screwdriver	Model	Standard Type	DLV7530-MKE	DLV7540-MKE	DLV7550-MKE	DLV8530-MKE	DLV8540-MKE	DLV8550-MKE	
		ESD Protection Type	DLV7530-BKE	DLV7540-BKE	DLV7550-BKE	DLV8530-BKE	DLV8540-BKE	DLV8550-BKE	
	Starting Method	Lever Start				Push to Start			
	Power Source	From dedicated controller							
	Torque Adjustment	Stepless							
	Torque	(Nm [lbf-in])	0.5 to 1.7 [4.4 to 15.1]	3.5	1.2 to 2.7 [10.6 to 23.9]	2.0 to 4.5 [17.7 to 39.8]	0.5 to 1.7 [4.4 to 15.1]	1.2 to 2.7 [10.6 to 23.9]	2.0 to 4.5 [17.7 to 39.8]
	Free Speed	(min ⁻¹)	1100	700	500	1100	700	500	
	Screw Size	Machine Screw	2.6 to 4.0	3.5 to 5.0	4.5 to 6.0	2.6 to 4.0	3.5 to 5.0	4.5 to 6.0	
		Tapping Screw	2.3 to 3.5	3.0 to 4.0	4.0 to 5.0	2.3 to 3.5	3.0 to 4.0	4.0 to 5.0	
	Mass	(g [lbs])	650 [1.43]		750 [1.65]	650 [1.43]		750 [1.65]	
Cord Length	(m)	3							
Rated Operation	ON: 0.5 seconds / OFF: 3.5 seconds								

Model	DLC4511-GGB	DLR1510-JE	
Function	Stepless speed adjustment 80 to 100% Soft start: adjustable time setting of slow speed (max. 3 sec.) External output signals: start and torque up Electro-static discharge(ESD) control	Screw counting: OK lamp and buzzer for notification Variable non-operation time Setting protection by key lock switch Setting by touch switch for easy operation External output signals: Start, Torque up, Count up & Cycle OK	
Power Source	230 V AC, 50/60 Hz		
Mass	(g [lbs])	3500 [7.72]	5100 [11.24]
Power Cord Length	(m)	2	
Plug Shape	Europe		

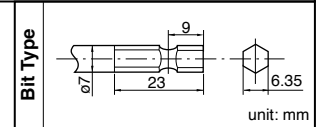

ESD protection measure

Measurement Point		Conventional Product	DLV7500 DLV8500-BKE
Handle	Static Electricity (V)	350	5
	Surface Resistance (Ω)	more than 10 ¹³	10 ⁴
Lever Switch	Static Electricity (V)	350	2
	Surface Resistance (Ω)	more than 10 ¹³	10 ⁴
Forward / Reverse Switch	Static Electricity (V)	25	2
Connection Cord	Static Electricity (V)	110	5
	Surface Resistance (Ω)	more than 10 ¹³	10 ¹⁰

Part	Material
Handle Lever Switch	Synthetic resin with carbon fiber
Power Cable	Anti-static material

*Measurement conditions (Temperature: 22°C Humidity: 66%)

(1) Static electricity

- Earth the measurement equipment and measuring person.
- Grip the screwdriver five times using Ansel Edmont electronic control glove.
- Turn on the switch of the screwdriver.
- Measure each part of the screwdriver using electronic measurement equipment manufactured by Shishido electrostatic Ltd.

(2) Surface resistance

- Measure using Simco Japan surface resistivity measurement equipment.

Standard Accessories

Model		DLV7530/DLV7540 DLV8530/DLV8540	DLV7550-MKE DLV8550-MKE	DLV7550-BKE DLV8550-BKE
Bit NK35	No.1 × 7 × 75	1	-	-
	No.2 × 7 × 75	1	1	1
	No.3 × 7 × 50	-	1	1
Pistol Grip	DLW2300	-	1	-
	DLW2300ESD	-	-	1
Spare Carbon Brush		2		
Connection Cord Straight 3 m (For MKE: TD01838 For BKE: TD02488)		1		
Suspension Bail		1		

*There are no vacuum pickup options available for this model.

Torque Diagrams (for reference)

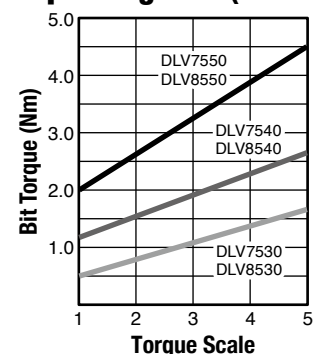

Transformerless (AC)
 Brush motor Brushless motor
 Miniature screw Precision screw Machine screw
 1.0 to 3.5 mm

See page 59 for External Dimensions

Delvo



DLV7000 series DLV8000 series

DLV7000 DLV8000 Series Non-CE

Features

100 V AC Direct Transformerless Precision Miniature Screw Type

- A built-in controller model saves space and facilitates layout change
- High repetitive torque accuracy
- Available with lever type (DLV7000 series) for each screw alignment and push to start type (DLV8000 series) for rapid screw tightening
- The high-speed type (DLV7031/DLV8031) available at 1200 min⁻¹ for improving work efficiency

Specifications

		Standard				High Speed		
Electric Screwdriver	Model	100 V AC Input	DLV7020-EMN	DLV7030-EMN	DLV8020-EMN	DLV8030-EMN	DLV7031-EMN	DLV8031-EMN
	Starting Method		Lever Start		Push to Start		Lever Start	Push to Start
	Torque Adjustment		Stepless					
	Torque	(Nm [lbf·in])	0.05 to 0.55 [0.4 to 4.9]	0.3 to 1.1 [2.7 to 9.7]	0.1 to 0.55 [0.9 to 4.9]	0.3 to 1.1 [2.7 to 8.9]	0.3 to 1.0 [2.7 to 8.9]	
	Free Speed	(min ⁻¹)	900	650	900	650	1200	
	Power Consumption	(W)	Approx. 25				Approx. 30	
	Screw Size	Machine Screw	1.0 to 3.0	2.0 to 3.5	1.0 to 3.0	2.0 to 3.5	2.0 to 3.0	
		Tapping Screw	1.2 to 2.6	2.0 to 3.0	1.2 to 2.6	2.0 to 3.0	2.0 to 3.0	
	Mass	(g [lbs])	400 [0.88]		410 [0.90]		400 [0.88]	410 [0.90]
	Rated Operation		ON: 0.5 seconds / OFF: 3.5 seconds					
Power Cord Length	(m)	3						
Bit Type			Plug Shape Asia					

Standard Accessories

Model		DLV7020/DLV8020	DLV7030/DLV8030 DLV7031/DLV8031
Bit NK4D	No.0 × 2.5 × 44	1	-
	No.1 × 3 × 44	-	1
	No.1 × 4 × 44	1	-
	No.2 × 4 × 44	-	1
Suspension Bail		1	

Torque Diagrams (for reference)

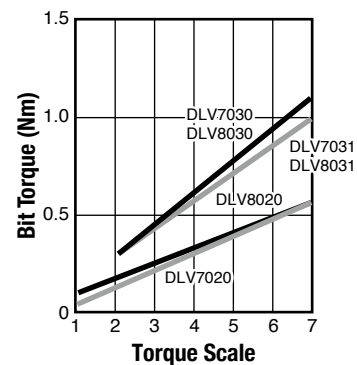

Optional Accessories

Sleeve for Vacuum Pickup DLS2000 Series See page 49 <p>Select according to the screw shape</p>	Vacuum Pickup DLP6500 See page 49 <p>For screw vacuum pickup *DLS2124/DLS2127/DLS2130 included</p>
Torque Adjustment Ring Cover DLW5300 <p>This minimizes tampering or accidental turning of the torque adjustment ring once the torque is set.</p>	



DLV7104 series DLV8104/DLV8204 series DLV8154

DLV7104/DLV8104 DLV8204 Series Non-CE

Features

The most popular models have been redesigned

- Equipped with bit grounding mechanism
- Long-life cam is utilized
- The clear plastic torque adjustment ring minimizes unintentional tampering of the preset torque
- The changeover switch enables operators to change forward/reverse rotation with a single hand
- The ergonomically designed grip can be held tightly to resist against tightening reaction force, resulting in reduced operator fatigue

Specifications

Model	Plug Shape: USA	DLV7124-MKE	DLV7134-MKE	DLV7144-MKE	DLV8124-MKE	DLV8134-MKE	DLV8144-MKE	High Torque	DLV8224-MKE	DLV8234-MKE	DLV8244-MKE
	Plug Shape: UK	DLV7124-MKH	DLV7134-MKH	DLV7144-MKH	DLV8124-MKH	DLV8134-MKH	DLV8144-MKH	DLV8154-MKH	DLV8224-MKH	DLV8234-MKH	DLV8244-MKH
Starting Method	Lever Start						Push to Start				
Power Source	230 V AC, 50/60 Hz										
Torque Adjustment	Stepless										
Torque (Nm) [lbf-in]	0.25 to 0.75 [2.2 to 6.6]	0.5 to 1.7 [4.4 to 15.1]	1.2 to 3.0 [10.6 to 26.6]	0.25 to 0.75 [2.2 to 6.6]	0.5 to 1.7 [4.4 to 15.1]	1.2 to 3.0 [10.6 to 26.6]	2.0 to 4.5 [17.7 to 39.8]	0.35 to 0.7 [3.1 to 6.2]	0.5 to 1.7 [4.4 to 15.1]	1.2 to 3.0 [10.6 to 26.6]	
Free Speed (min ⁻¹)	900		600	900		600	400	2000	1800	1100	
Power Consumption (W)	35						45				
Screw Size (mm)	Machine Screw	2.6 to 3.0	2.6 to 4.0	3.5 to 5.0	2.6 to 3.0	2.6 to 4.0	3.5 to 5.0	4.5 to 6.0	2.6 to 3.0	2.6 to 4.0	3.5 to 5.0
	Tapping Screw	2.3 to 3.0	2.3 to 3.5	3.0 to 4.0	2.3 to 3.0	2.3 to 3.5	3.0 to 4.0	4.5 to 5.0	2.3 to 3.0	2.3 to 3.5	3.0 to 4.0
Mass (g [lbs])	720 [1.59]			710 [1.57]			910 [2.01]		710 [1.57]		
Cord Length (m)	3										
Rated Operation	ON: 0.5 seconds / OFF: 3.5 seconds										
Bit Grounding	Equipped as standard										
Bit Type			For MKE				For MKH				
	Plug Shape	USA		UK		USA		UK		USA	

Please contact us for 5 mm bit type.

Standard Accessories

Model	MKE/MKH	8154-MKE/MKH	
Bit NK35	No.1 × 7 × 75	1	-
	No.2 × 7 × 75	1	1
	No.3 × 7 × 50	-	1
Pistol Grip	-	-	1
Spare Carbon Brush			2
Suspension Bail			1
Torque Adjustment Ring Cover DLW5201			1

Torque Diagrams (for reference)

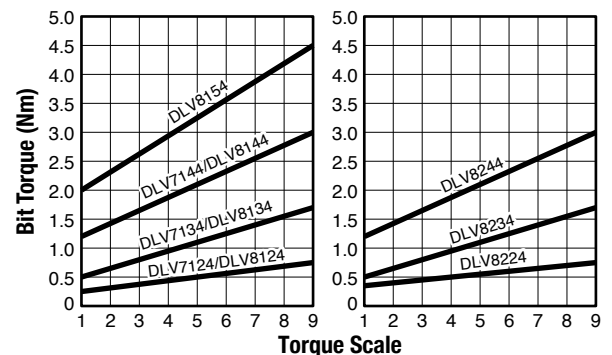

Optional Accessories

Pistol Grip DLW2300 See page 51 For operator fatigue reduction, suitable for horizontal fastening	Angle Attachment (for use with lever start type only) DLW9021 See page 52 For fastening work at right angles *Use with an output torque of 2.0 Nm or less	Vacuum Pickup DLP7401-K See page 49 For screw vacuum pickup DLS4220/DLS4221 included	Torque Adjustment Ring Cover DLW5201 Standard accessory
--	---	---	---

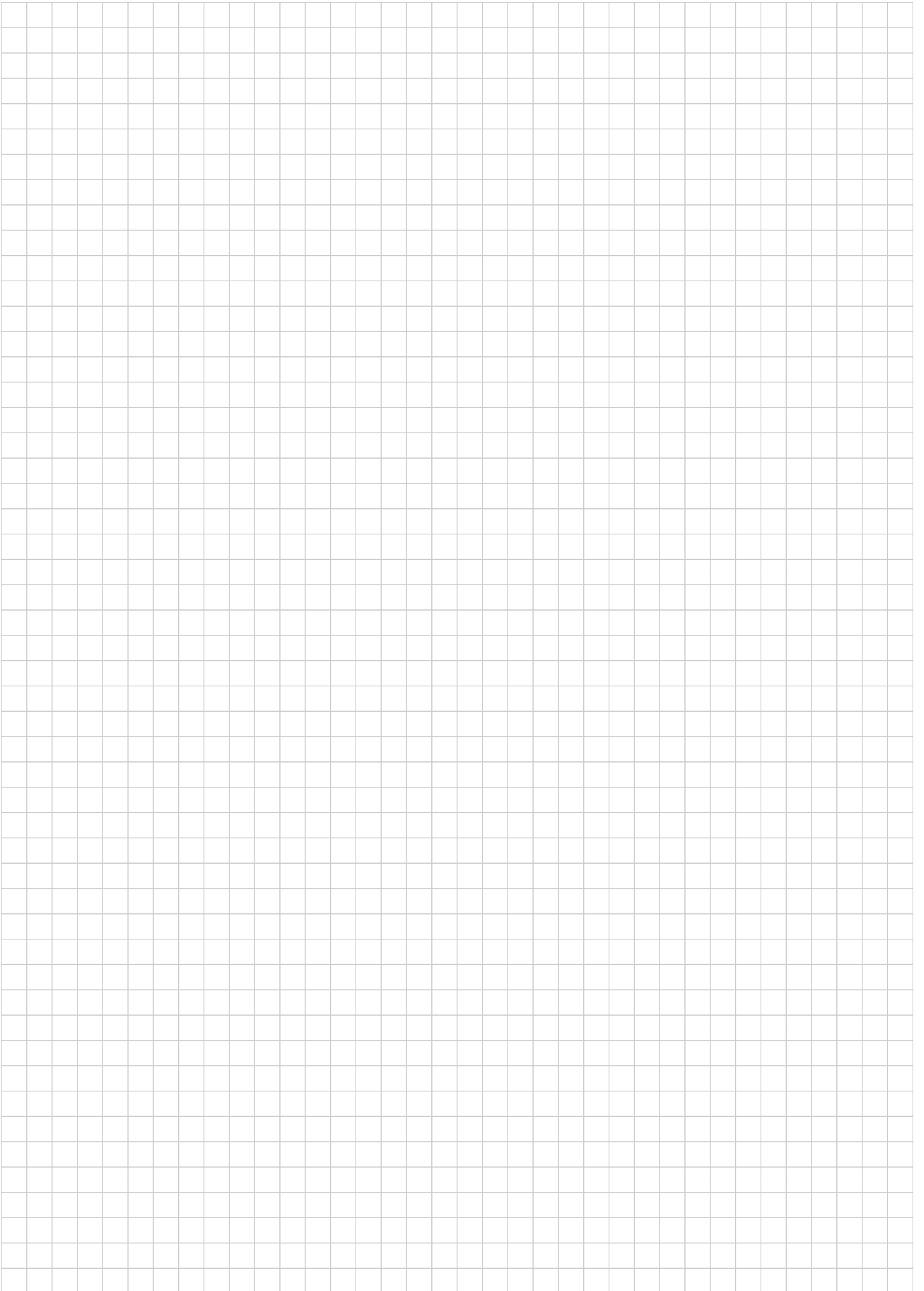

Screw Fastening Counter Series

Prevents human error with various functions. * Special models available on request

The error is detected based on the set tightening time.

Self adjustable timer function

The optimum value of screw tightening time is set from the actual screw tightening.



Count Correction Function

Does not count when error is detected.

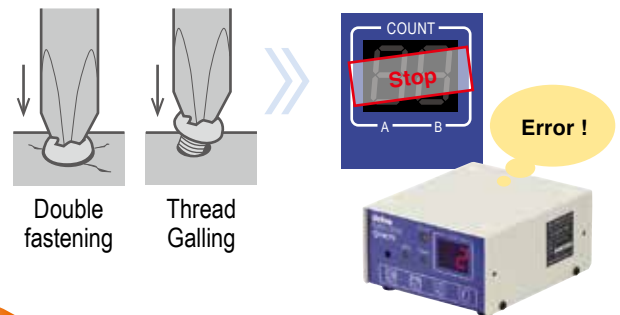

Human error prevention

Link Connection Function

Multiple screwdrivers can be linked. The other screwdrivers will be in standby state.

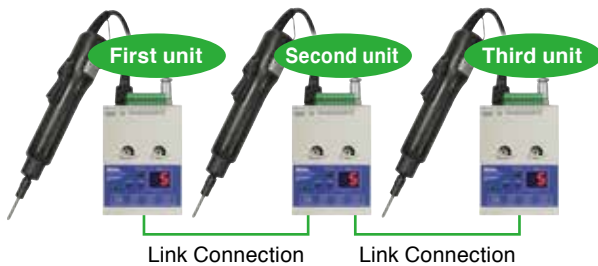

Count Return Function

The remaining number of screw tightening is returned when the rotation is reversed.

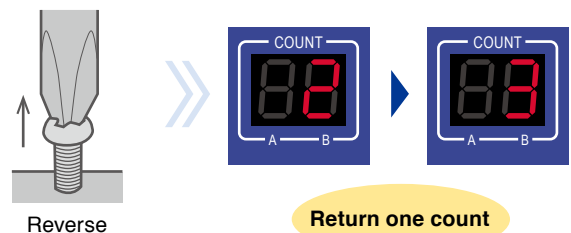

Driver Lock Function

Unnecessary screwdrivers are locked in conjunction with the workpiece sensor.

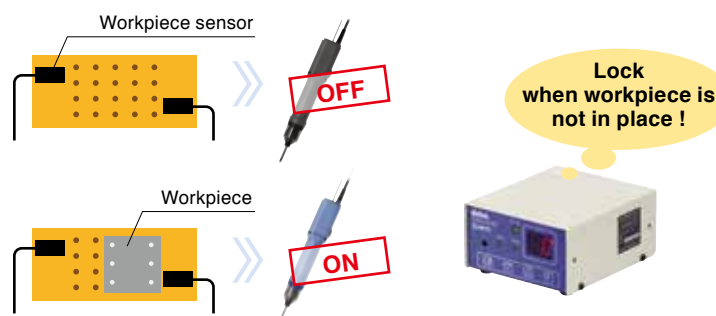

DLR5640-WN

- Functions of the controller and counter are integrated into a single unit.
- Equipped with Linear Start Function that gradually increases the rotation speed at start.
- Universal power input for use anywhere in the world.



Terminal block specifications

No.	Name	Definition	Remarks	I/O
1	⊕	+DC 24 V	Built-in power supply capacity 200 mA max.	
2	WORK	Work sensor input	Inputs the ON signal while a work is set.	Input
3	⊖	Common		
4	RESET	External reset input	DIP-SW4 Set to auto: Inputs the ON signal 1 second or longer. Set to manual: Inputs the ON signal 3 seconds or longer.	Input
5	OK	OK evaluation external output	ON until the work is released.	Output
6	NG	NG evaluation external output	ON until the work is set or the RESET switch is pressed.	Output
7	LINK-OUT	Link connection output	Connected from the last counter to LINK-IN of every preceding counter	Output
8	LINK-IN	Link connection input	From LINK-OUT of the last counter	Input
9	PARTS_A	External count input A	Inputs the ON signal when a part is removed.	Input
10	PARTS_B	External count input B		Input

DLR5040A-WE

- Compact and lightweight model.
- A wide range of SPC screwdriver types are available.



Terminal block specifications

No.	Name	Definition	Remarks	I/O
1	⊕	+DC 24 V	Built-in power supply capacity 200 mA max.	
2	WORK	Work sensor input	Inputs the ON signal while a work is set.	Input
3	⊖	Common		
4	RESET	External reset input	DIP-SW4 Set to auto: Inputs the ON signal 1 second or longer. Set to manual: Inputs the ON signal 3 seconds or longer.	Input
5	OK	OK evaluation external output	ON until the work is released.	Output
6	NG	NG evaluation external output	ON until the work is set or the RESET switch is pressed.	Output
7	LINK-OUT	Link connection output	Connected from the last counter to LINK-IN of every preceding counter	Output
8	LINK-IN	Link connection input	From LINK-OUT of the last counter	Input
9	PARTS_A	External count input A	Inputs the ON signal when a part is removed.	Input
10	PARTS_B	External count input B		Input

DLR5340-WE

- Three dedicated screwdrivers can be connected.
- Eight kinds of screw fastening conditions can be stored in internal memory.



Terminal block specifications

No.	Name	Definition	Remarks	I/O
1	⊕	+DC 24 V	Built-in power supply capacity 200 mA max.	
2	WORK	Work sensor input	Inputs the ON signal while a work is set.	Input
3	⊖	Common		
4	RESET	External reset input	Switch to the on position for one second or more to trigger a reset.	Input
5	OK	OK evaluation external output	Signal is kept on until work is released.	Output
6	NG	NG evaluation external output	Signal is kept on until work is re-set or reset switch is pressed.	Output
7	COUNT-UP	Count signal	Signal is switched ON for 0.1 second at successful completion of screw fastening.	Output
8	DRIVER	A	Active driver signal	Signals from only now-operable drivers are switched on.
9		B		
10		C		
11	TORQUE CHECK	Torque check signal	The driver works freely while torque check signal is being input.	Input
12	ch	1	Channel designation signal	For channel-by-channel designation, input normal signals while at operation. (Channel designation is unchangeable during operation.)
13		2		
14		3		

Function List

	Self adjusting timer function	Count correct function	Link connection function	Count return function	Driver lock function	Number of connecting ports
DLR5640-WN	•	•	•	•	•	1
DLR5040A-WE	•	•	•	•	•	1
DLR5340-WE	•	•	• (No wiring required)	•	•	3

DLR5640-WN Non-CE

Features

The self-adjustable timer function automatically assesses the time required to complete fastening each screw and reflects it on the judging time setting

- Ideally suited for the assembly lines of vehicles and electrical equipment requiring reliable screw fastening
- The controller receives signals from electric screwdrivers to provide highly reliable screw fastening control
- Functions of the controller and counter are integrated into a single unit
- Count Return Function: When a screw is loosened, a reverse signal output from the electric screwdriver reverses the count by one
- The self-adjustable timer function automatically assesses the time required to complete tightening each screw and reflects it on the judging time setting
- The Count Correction Function does not count fastening errors such as elevated screws or double fastening
- External Count Function: To be available to various assembling jobs, the DLR5640 enables counting of two kinds of parts (up to 9 counts each) in addition to the screw tightening counting. These kinds of counting can be used together.
- Link Connection Function: You can build up a simple sequential screw tightening system by connecting the DLR5640 screw tightening counters in series without using any external controller such as a programmable controller
- Driver Lock Function prevents unexpected start of screwdrivers
- Desktop or wall-hung installation is available
- Input voltage range from 100 V AC to 240 V AC is acceptable in any part of the world



Specifications

Model	DLR5640-WN
Count	1 to 99
Counting Method	Count-up / Count-down
Count Correction Function	Count normal fastening only
Self Adjustable Timer Setting	0.01 to 0.99 sec.
Work Detection Function	Yes (1 terminal) / No
External Count Input	2 terminals (PARTS A / PARTS B)
Work Installation Timer Setting	0 to 9.5 sec.
OK Output Timer Setting	0 to 9.5 sec.
NG Alarm	ON(1) / ON(2) / OFF
OK Buzzer	ON(1) / ON(2) / ON(3) / OFF
Count Return Function	ON / OFF
NG Judge Timing	WORK SET / DRIVER ON
Automatic / Manual OK Judge	AUTO / MANUAL
Screwdriver Lock Function	ON / OFF
Multiple Link	Up to 10 counters can be connected.
External Inputs on Terminal Block(NPN)	SENSOR / RESET / LINK-IN / PARTS A / PARTS B
External Outputs on Terminal Block(NPN)	OK / NG / LINK-OUT
Parameter Memory	Parameters stored in internal nonvolatile memory
Screwdriver Control	SPEED / LINEAR START
Power Source	100 - 240 V AC, 50/60 Hz
Screwdriver Power Supply	33 V DC, 1.5 A
External Dimensions (mm [inch])	W101 x D140 x H57 [W3.98" x D5.51" x H2.24"]
Mass (g [lbs])	800 [1.76]
Accessories	2 m Power cord with 3-prong USA plug Suspension bail (2 pcs.)

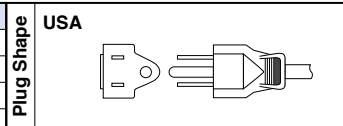

Example of use together with a sensor available in the market

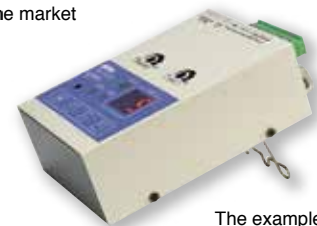

The example of installation

Screwdrivers designed

for **DLR5640-WN** Non-CE

Screw Fastening Counter



DLR5640-WN

Specifications

Model	DLV7410A-SPC	DLV7410HA-SPC	DLV7420A-SPC	DLV7321-SPC	DLV7331-SPC
Starting Method	Lever Start				
Torque Adjustment	Stepless				
Torque (Nm [lbf·in])	0.02 to 0.2 [0.2 to 1.8]		0.15 to 0.4 [1.3 to 3.5]	0.1 to 0.5 [1.9 to 4.4]	0.3 to 1.2 [2.7 to 10.6]
Free Speed (min ⁻¹)	500 to 750	700 to 1000	450 to 600	300 to 1000	200 to 700
Power Consumption (W)	Approx. 10			Approx. 35	
Screw Size (mm)	Machine Screw	1.0 to 2.3	1.6 to 2.6	1.0 to 3.0	2.0 to 3.5
	Tapping Screw	1.0 to 2.0	1.4 to 2.3	1.2 to 2.6	2.0 to 3.0
Electrostatic Countermeasure	Complied with EN100015-1				
Mass (g [lbs])	230 [0.51]			350 [0.77]	
Cord Length (m)	1.5 (with connector)				
Rated Operation	ON: 0.5 seconds / OFF: 3.5 seconds				
Bit Grounding	Equipped as standard				

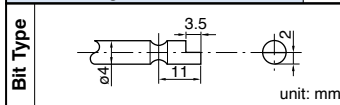

Combinations with Electric Screwdrivers

Screwdriver Model	Connection	Remarks
DLV7410A/7410HA/7420A-SPC	The cord comes with screwdriver	Screwdriver for the screw fastening counter only
DLV7321/DLV7331-SPC	Direct connection to power source	
DLV7410A/DLV7410HA/DLV7420A/DLV7419A/DLV7419HA/DLV7429A-BMN	Optional conversion cord (TD02925 DLW9072)	General-purpose screwdriver*

* The Count Return Function is not available.

Optional Accessories

Optional conversion cord 1.5 m DLW9072	Torque Adjustment Ring Cover DLW5300	Torque Adjustment Ring Cover DLW5700
	 For DLV7300-SPC This minimizes tampering or accidental turning of the torque adjustment ring once the torque is set.	 For DLV7400A-SPC This minimizes tampering or accidental turning of the torque adjustment ring once the torque is set.

LINK Function (Common to DLR5040A & DLR5640)

When counters are connected and activated in the screw fastening sequence as shown on the right, all screwdrivers are on standby except the first one in the sequence. Only when the first screw fastening is finished, can the next screwdriver change from standby to ready. When the last fastening in the sequence is finished, the first screwdriver is once again ready and the sequence can be repeated again.
N.B. Up to 10 screwdriver/counter sets can be connected to the LINK.

See page 61 for External Dimensions



Specifications

Model	DLR5040A-WE	
Count	1 to 99	
Counting Method	Count-up / Count-down	
Count Correction Function	Count normal fastening only	
Self Adjustable Timer Setting	0.01 to 0.99 sec.	
Work Detection Function	Yes (1 terminal) / No	
External Count Input	2 terminals (PARTS A / PARTS B)	
Work Installation Timer Setting	0 to 9.5 sec.	
OK Output Timer Setting	0 to 9.5 sec.	
NG Alarm	ON(1) / ON(2) / OFF	
OK Buzzer	ON(1) / ON(2) / ON(3) / OFF	
Count Return Function	ON / OFF	
NG Judge Timing	WORK SET / DRIVER ON	
Automatic / Manual OK Judge	AUTO / MANUAL	
Screwdriver Lock Function	ON / OFF	
Multiple Link	Up to 10 counters can be connected.	
External Inputs on Terminal Block(NPN)	SENSOR / RESET / LINK-IN / PARTS A / PARTS B	
External Outputs on Terminal Block(NPN)	OK / NG / LINK-OUT	
Parameter Memory	Parameters stored in internal nonvolatile memory	
Power Source	100 - 240 V AC, 50/60 Hz	
Output Voltage	Same as Input Voltage	
External Dimensions	(mm [inch])	W100 x D120 x H60 [W3.94" x D4.72" x H2.36"]
Mass	(g [lbs])	470 [1.04]

Accessory: 2 m cord with UL 3-prong plug. This product is for use outside Japan.

DLR5040A-WE Non-CE

Features

For prevention of human fastening errors and enhanced fastening management accuracy

- Ideally suited for the assembly lines of vehicles and electrical equipment requiring reliable screw fastening
- The controller receives signals from electric screwdrivers to provide highly reliable screw fastening control
- Count Return Function: When a screw is loosened, a reverse signal output from the electric screwdriver reverses the count by one
- The Count Correction Function does not count elevated screws or double fastening
- Input voltage range from 100 to 240 V AC is acceptable in any part of the world
(The screwdrivers to be used in combination with the counter require input power supplies that are written on the respective nameplate)
- Link Connection Function: You can build up a simple sequential screw tightening system by connecting the DLR5040A-WE screw tightening counters in series without using any external controller such as a programmable controller
- Driver Lock Function prevents unexpected start of screwdrivers
- Compact and Lightweight (Compared with our conventional models decreased by 30% in volume and by 38% in mass)
- SPC type screwdrivers for DLR5040A-WE are designed on the basis of established transformerless screwdrivers



LINK Function (Common to DLR5040A & DLR5640)

When counters are connected and activated in the screw fastening sequence as shown on the right, all screwdrivers are on standby except the first one in the sequence. Only when the first screw fastening is finished, can the next screwdriver change from standby to ready. When the last fastening in the sequence is finished, the first screwdriver is once again ready and the sequence can be repeated again. N.B. Up to 10 screwdriver/counter sets can be connected to the LINK.

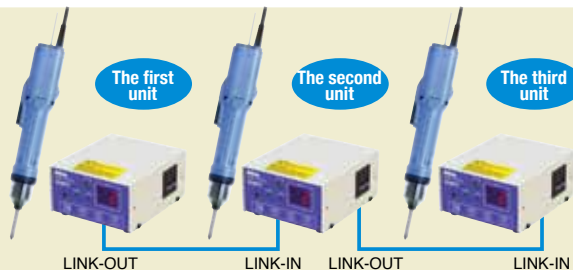

Example of use together with a sensor available in the market

See page 61 for External Dimensions



Specifications

Model	DLR5340-WE	
Count	0 to 99	
Counting Method	Count-up / Count-down	
Count Correction Function	Count normal fastening only	
Self Adjustable Timer Setting	0.01 to 2.50 sec.	
Work Detection Function	Yes (1 terminal) / No	
Work Installation Timer Setting	0 to 9.5 sec.	
OK Output Timer Setting	0 to 9.5 sec.	
NG Alarm	ON(1) / ON(2) / OFF	
OK Buzzer	ON(1) / ON(2) / ON(3) / ON(4) / ON(5) / OFF	
Count Return Function	ON / OFF	
Screwdriver Lock Function	ON / OFF	
Screwdriver Cord Connection	Single cord connection (Signal and power lines)	
External Inputs on Terminal Block(NPN)	SENSOR / RESET / TORQUE CHECK / ch1/2/3	
External Outputs on Terminal Block(NPN)	OK / NG / COUNT-UP / DRIVER A/B/C	
Power Source	100 - 240 V AC, 50/60 Hz	
Output Voltage	Same as Input Voltage	
External Dimensions	(mm [inch])	W150 x D120 x H60 [W5.91" x D4.72" x H2.36"]
Mass	(g [lbs])	620 [1.37]

Accessory: 2 m cord with UL 3-prong plug. This product is for use outside Japan.

DLR5340-WE Non-CE

Features

Up to three sets of screwdrivers can be connected to one counter

- Up to eight kinds of screw fastening conditions* can be stored in internal memory for a wide variety of assembly work.
*Screw fastening conditions switchable by an external signal.
- Count-up signal outputs
- Space saving
- The Count Correction Function does not count elevated screws or double fastening as fastening errors.
- Count Return Function: When a screw is loosened, a reverse signal output from the electric screwdriver reverses the count by one.

Dedicated Screwdrivers

for DLR5040A-WE and DLR5340-WE Non-CE

*Please contact us for other than 100 V AC availabilities.

Small



Specifications

		Miniature Screw (1.0 to 3.5 mm)					
Model	Lever Start	DLV7020-SPC	DLV7030-SPC	DLV7031-SPC	-	-	-
	Push to Start	-	-	-	DLV8020-SPC	DLV8030-SPC	DLV8031-SPC
Power Source		100 V AC, 50/60 Hz From screw counter					
Torque Adjustment		Stepless					
Torque (Nm [lbf-in])		0.05 to 0.55 [0.4 to 4.9]	0.30 to 1.10 [2.7 to 9.7]	0.30 to 1.00 [2.7 to 8.9]	0.10 to 0.55 [0.9 to 4.9]	0.30 to 1.10 [2.7 to 9.7]	0.30 to 1.00 [2.7 to 8.9]
Free Speed (min ⁻¹)		900	650	1200	900	650	1200
Power Consumption (W)		Approx. 25		Approx. 30	Approx. 25		Approx. 30
Screw Size (mm)		Machine Screw	1.0 to 3.0	2.0 to 3.5	2.0 to 3.0	1.0 to 3.0	2.0 to 3.5
		Tapping Screw	1.2 to 2.6	2.0 to 3.0		1.2 to 2.6	2.0 to 3.0
Bit Type		A					
Mass (g [lbs])		380 [0.84]			390 [0.86]		
Cord Length (m)		3 (with connector)					
Rated Operation		ON: 0.5 seconds / OFF: 3.5 seconds					
Bit Grounding		Equipped as standard					

Screw Size



		Machine Screw (2.6 to 8.0 mm)					
Model	Lever Start	DLV7120-SPC	DLV7130-SPC	DLV7140-SPC	DLV7231-SPC	DLV7241-SPC	
	Push to Start	DLV8120-SPC	DLV8130-SPC	DLV8140-SPC	DLV8231-SPC	DLV8241-SPC	
Power Source		100 V AC, 50/60 Hz From screw counter					
Torque Adjustment		Stepless					
Torque (Nm [lbf-in])		0.35 to 0.70 [3.10 to 6.20]	0.50 to 1.70 [4.4 to 15.1]	1.20 to 3.00 [10.6 to 26.6]	0.50 to 1.70 [4.4 to 15.1]	1.20 to 3.00 [10.6 to 26.6]	
Free Speed (min ⁻¹)		1000		700	2000		
Power Consumption (W)		35			45		
Screw Size (mm)		Machine Screw	2.6 to 3.0	2.6 to 4.0	3.5 to 5.0	2.6 to 4.0	
		Tapping Screw	2.3 to 3.0	2.5 to 3.5	3.0 to 4.0	2.5 to 3.5	3.0 to 4.0
Bit Type		B *					
Mass (g [lbs])		710 [1.57] (7100series) / 670 [1.48] (8100series)			710 [1.57] (7200series) / 670 [1.48] (8200series)		
Cord Length (m)		3 (with connector)					
Rated Operation		ON: 0.5 seconds / OFF: 3.5 seconds					
Bit Grounding		Equipped as standard					



		Machine Screw (2.6 to 8.0 mm)	
Model	Lever Start	-	DLV7251-SPC
	Push to Start	DLV8150-SPC	DLV8251-SPC
Power Source		100 V AC, 50/60 Hz From screw counter	
Torque Adjustment		Stepless	
Torque (Nm [lbf-in])		2.0 to 4.5 [17.7 to 39.8]	
Free Speed (min ⁻¹)		450	700
Power Consumption (W)		45	
Screw Size (mm)		Machine Screw	4.5 to 6.0
		Tapping Screw	4.0 to 5.0
Bit Type		C	
Mass (g [lbs])		810 [1.79]	
Cord Length (m)		3 (with connector)	
Rated Operation		ON: 0.5 seconds / OFF: 3.5 seconds	
Bit Grounding		Equipped as standard	

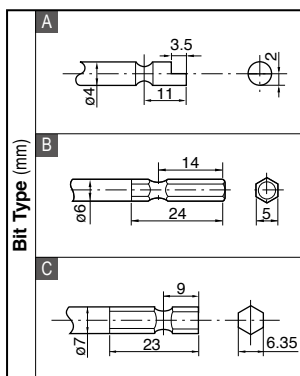

Big

		Machine Screw (2.6 to 8.0 mm)					
Model	Lever Start	DLV30A06L-SPC	DLV30A12L-SPC	DLV30A20L-SPC	DLV45A06L-SPC	DLV45A12L-SPC	DLV70A06L-SPC
	Push to Start	DLV30A06P-SPC	DLV30A12P-SPC	DLV30A20P-SPC	DLV45A06P-SPC	DLV45A12P-SPC	DLV70A06P-SPC
Power Source		100 V AC, 50/60 Hz From screw counter					
Torque Adjustment		Stepless					
Torque (Nm [lbf-in])		0.4 to 1.6 / 1.2 to 3.0 [3.5 to 14.2 / 10.6 to 26.6]			2.0 to 4.5 [17.7 to 39.8]		3.8 to 7.0 [33.6 to 62.0]
Free Speed (min ⁻¹)		650	1200	2000	650	1200	650
Power Consumption (W)		45					
Screw Size (mm)		Machine Screw	2.6 - 5.0		4.5 - 6.0		5.0 - 8.0
		Tapping Screw	2.5 - 4.0		4.0 - 5.0		4.5 - 6.0
Bit Type		B *				C	
Mass (g [lbs])		700 [1.54]		870 [1.92] with pistol grip			
Cord Length (m)		3 (with connector)					
Rated Operation		ON: 0.5 seconds / OFF: 3.5 seconds					
Bit Grounding		Equipped as standard					

*Please contact us for 6.35 mm bit type.

Optional Accessories

Torque Adjustment Ring Cover		Torque Adjustment Ring Cover		Pistol Grip DLW2300ESD	SPC cord 0.5 m DLW9400	SPC Extension Cable 3 m DLW9340
DLW5200	DLW5300	DLW5201 (Non-ESD)	DLW5202	 See page 51 ESD Protection For DLV7100/DLV7200/ DLV8100/DLV8200/ DLV30A/DLV45/DLV70A -SPC		
 For DLV7100/ DLV7200/DLV8100/ DLV8200-SPC	 For DLV7000/ DLV8000-SPC	 For DLV30A-SPC	 For DLV45A/DLV70A -SPC	For operator fatigue reduction, suitable for horizontal fastening	For commercial power source	Extends cord length between screw fastening counter and screwdriver

Transformerless (AC)
 Brush motor **Brushless motor**
 Miniature screw Precision screw **Machine screw**
2.6 to 8.0 mm

See page 62 for External Dimensions

Delvo Brushless Type



A Series (For automation)

Model **DLV30A/DLV45A/DLV70A** Non-CE

Features

For automatic assembly robots

- Three series of screwdrivers can be mounted on XY robots
- Automatic screw tightening achieves a labor-saving or unattended process
- Long-life brushless motors are incorporated in the electric screwdrivers
- The electric screwdriver generates the torque-up signal
- The screwdrivers can be connected to a sequencer to control starting, forward rotation, and reverse rotation
- An electrical noise preventive measure is employed to avoid malfunction. Each input/output signal is insulated from the screwdriver's internal circuit by a photocoupler
- Standard coupling, flange coupling, and left-hand thread coupling are available for installation

DLV45A06A-F

The Vacuum Pickup is optional.



DLV45A12A-N



Standard coupling

Flange coupling

left-hand thread coupling



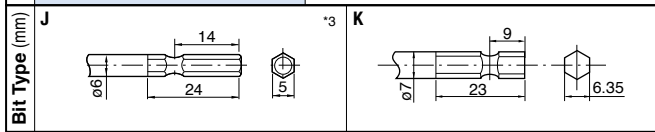

Specifications

		Low Speed	Standard	High Speed	Low Speed	Standard	Low Speed
Model: Bit	Standard coupling	DLV30A06A-N(AA) : J	DLV30A12A-N(AA) : J	DLV30A20A-N(AA) : J	DLV45A06A-N(AA) : K	DLV45A12A-N(AA) : K	DLV70A06A-N(AA) : K
	Coupling with flange	DLV30A06A-F(AA) : J	DLV30A12A-F(AA) : J	DLV30A20A-F(AA) : J	DLV45A06A-F(AA) : K	DLV45A12A-F(AA) : K	DLV70A06A-F(AA) : K
	Coupling with M41 screw	DLV30A06A-M(AA) : J	DLV30A12A-M(AA) : J	DLV30A20A-M(AA) : J	DLV45A06A-M(AA) : K	DLV45A12A-M(AA) : K	DLV70A06A-M(AA) : K
Power Source		100 V AC, 50/60 Hz					
Torque Adjustment		Stepless					
Torque (Nm [lbf-in])	Low Torque Spring*1	0.4 to 1.6 [3.5 to 14.2]			2.0 to 4.5 [17.7 to 39.8]		3.8 to 7.0 [33.6 to 62.0]
	High Torque Spring*2	1.2 to 3.0 [10.6 to 26.6]					
Free Speed (min ⁻¹)		650	1200	2000	650	1200	650
Screw	Machine Screw	2.6 to 5.0			4.5 to 6.0		5.0 to 8.0
Size (mm)	Tapping Screw	2.5 to 4.0			4.0 to 5.0		4.5 to 6.0
Mass (g [lbs])	Standard coupling	700 [1.54]			780 [1.72]		
	Coupling with flange	760 [1.68]			840 [1.85]		
	Coupling with M41 screw	740 [1.63]			820 [1.81]		
Power Consumption (W)		45					
Starting Method		External input signal					
Input signal(NPN)		Start signal / Forward signal / Reverse signal (5 - 24 V DC)					
Output signal(NPN)		Torque-up signal (Voltage under 30 V DC and current 20 mA)					
Rated Operation		ON: 0.5 seconds / OFF: 3.5 seconds					
Bit Grounding		Equipped as standard					
Standard Accessories		• Bit NK31 (No.2 × 6 × 70): 1 pc. • Low torque spring: 1 pc.			• Bit NK35 (No.2 × 7 × 75): 1 pc.		



*1: Standard Accessory
 *2: Installed
 *3: DLV30A is available upon request for use with 6.35 mm hex. shank bits.

Optional Accessories

Sleeve for Vacuum Pickup DLS4000 Series See page 49  Select according to the screw shape	Vacuum Pickup DLP7401-J See page 49  For Hex. 5 mm (DLV30A) *DLS3223/DLS3225 included	Vacuum Pickup DLP7401-K See page 49  For Hex. 6.35 mm (DLV45A/DLV70A) *DLS4220/DLS4221 included
Screw Vacuum Pump DLP2530 (100 V AC) DLP2570 (230 V AC) See page 51  Connect the tube to the vacuum pickup port. The vacuum will pick up the screw.		

Torque Diagrams (for reference)

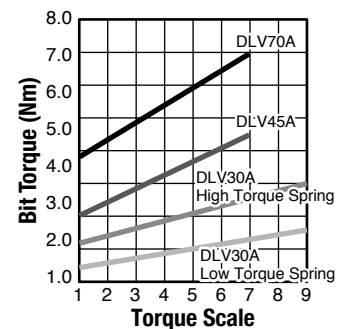

Screwdriver Cable Breakdown List

Power/Input Signal Cable (3 m)

Color	Details
Green	Power input
Yellow	Power input
Blue	Bit earth
White	Input signal common (Vcc)
Black	Start signal input
Orange	Forward signal input
Gray	Reverse signal input

Power input voltage: 100 V AC

Output Signal Cable (3 m)

Color	Details
White	Torque-up signal output
Black	Ground

Power Input/Output Signal Schematic Diagram

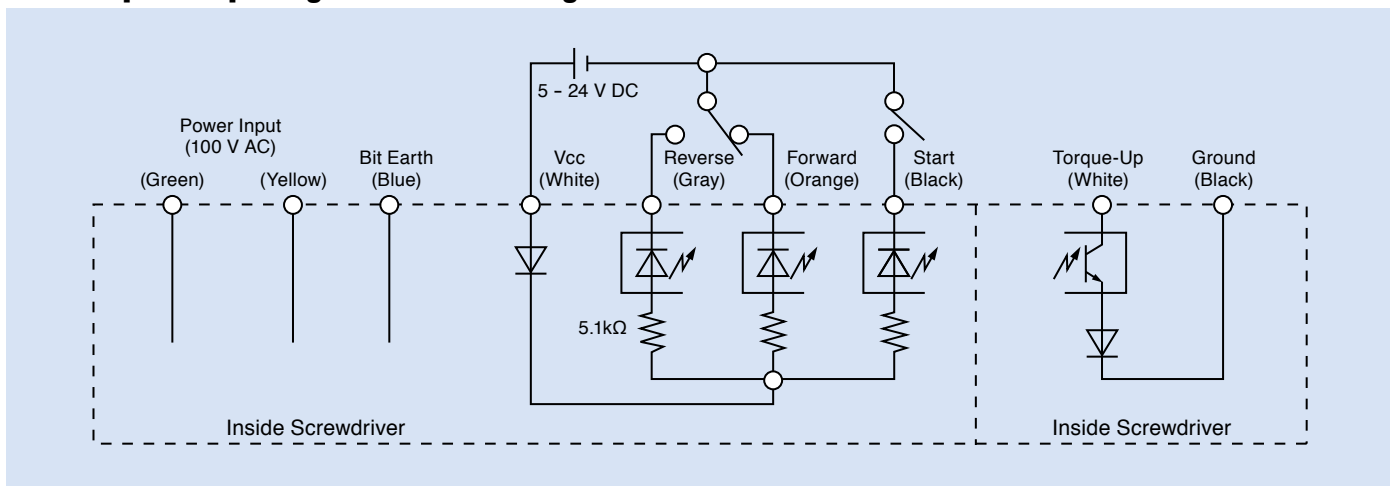

⚠ Caution

- Each input/output signal is insulated from a screwdriver's internal circuit.
- Input signal rated range: Use in the range of voltage between 5 – 24 V DC (current 0.5 – 5 mA DC)
- Torque-up signal output maximum rating: Use in the range of voltage under 30 V DC and current 20 mA DC.

Operation Timing Chart

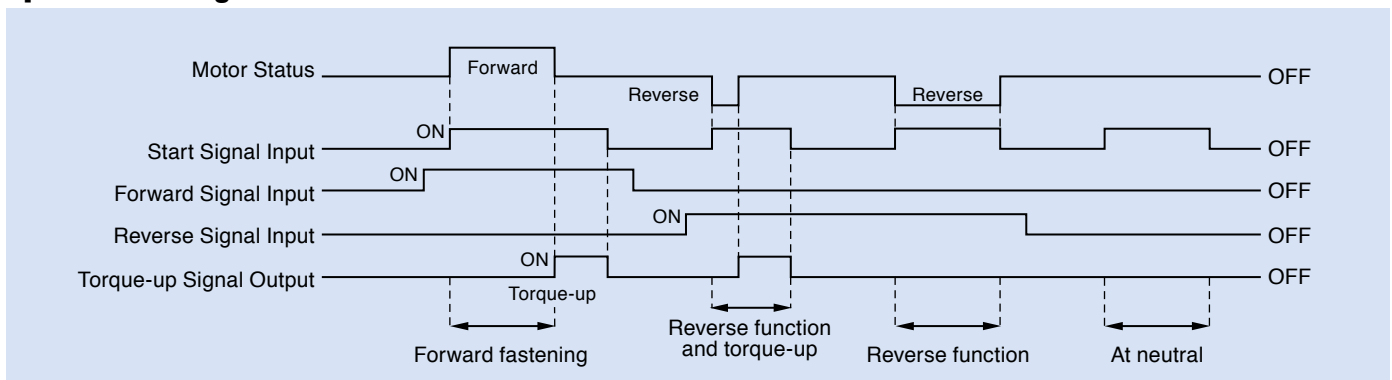

⚠ Caution

- Input the start signal after inputting the forward/reverse signal.
- Do not input the forward signal and reverse signal at the same time.
- After confirming that the wiring is correct, turn the power ON.
- When energizing the power cable or signal lines with incorrect wiring, failure of the device could result.
- Use an I/O signal within the rating.
- Using voltage or current that exceeds the rated value could cause device failure.
- Do not directly connect a relay or lamp to the signal output to control.
- The effects of surges, etc. generated from an induced load could cause device failure.
- Make sure that screwdriver rotation is completely stopped and then switch between forward and reverse rotation.
- If the rotation direction is switched while the screwdriver is rotating, the motor suddenly stops.
- Do not forcefully bend or pull the signal line.
- Doing so could cause a broken signal line or detachment from the screwdriver, causing device failure.
- To avoid excess load in the axis direction, use a level switch to properly set the height.
- The recommended pressing force is 1 kg or less.





DLV3100 Series



DLV3300 Series



DLV3100 series DLV3300 series



DLC3310

DLV3100/DLV3300 Series

(For automation) Non-CE

Features

A Labor-Saving "delvo" for Automatic Assembly Robots

- Vibration-proof and shock-proof for long continuous screw tightening
- Torque-up signal output
- High repetitive torque accuracy

*For forward rotation only

Specifications

	For Precision Screws			For Machine Screws		
	DLV3321-CMN	DLV3331-CMN	DLV3121-EJN*	DLV3131-EJN*	DLV3141-EJN*	DLV3151-EJN**
Model	DLC3310			-		
Power Source	36 V DC (supplied from controller)			100 V AC, 50/60 Hz		
Torque Adjustment	Stepless					
Torque (Nm [lbf-in])	0.05 to 0.5 [0.4 to 4.4]	0.3 to 1.2 [2.7 to 10.6]	0.25 to 0.7 [2.2 to 6.2]	0.5 to 1.5 [4.4 to 13.3]	1.2 to 3.0 [10.6 to 26.6]	2.0 to 4.5 [17.7 to 39.8]
Free Speed (min ⁻¹)	900	600	900	600	450	
Power Consumption (W)	Approx. 35			Approx. 45		
Screw Size (mm)	Machine Screw: 1.0 to 3.0 Tapping Screw: 1.2 to 2.6	2.0 to 3.5 2.0 to 3.0	2.3 to 2.6 2.3 to 3.0	2.6 to 3.5 2.5 to 3.5	3.5 to 5.0 3.0 to 4.0	4.5 to 6.0 4.0 to 5.0
Starting Method	Voltage input					
Mass (g [lbs])	400 [0.88]			900 [1.98]		
Rated Operation	ON: 0.5 seconds / OFF: 3.5 seconds					
Standard Accessories	• Connection Cord (2 m): 1 pc. • Spare Carbon Brush: 2 pc.					

Controller	DLC3310	
	Model	DLC3310
Power Source	24 V AC, 50/60 Hz	
Output Voltage	36 V DC	
Mass (g [lbs])	360 [0.79]	
Standard Accessories	Connection Cord (2 m) for DLV3321/DLV3331: 1pc.	

Bit Type (mm)	For CMN	For EJN

*These models have no bit holding function. If required, please order the models as below. (Made-to-order)

- DLV3121 → DLV3128-EJN • DLV3131 → DLV3138-EJN
- DLV3141 → DLV3148-EJN • DLV3151 → DLV3158-EJN

(The bit holding method of the above models is different from the other screwdrivers.)

Bit holding method (For DLV3128/DLV3138/DLV3148/DLV3158)

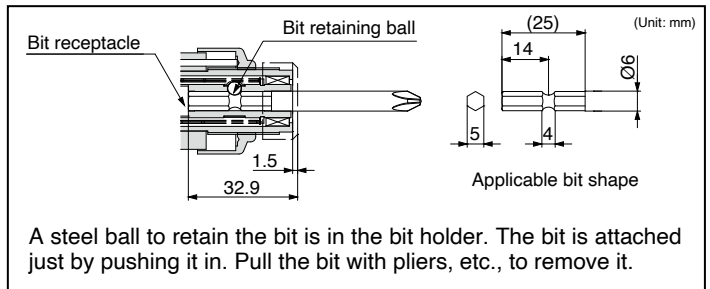
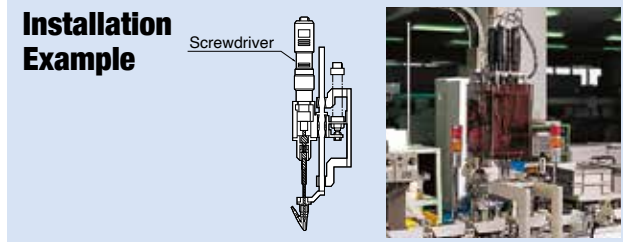

Optional Accessories

For Vacuum Pickup
 See page 49

Select according to the screw shape

Vacuum Pickup DLP6500
 See page 49

For screw vacuum pickup *DLS2124/DLS2127/DLS2130 included

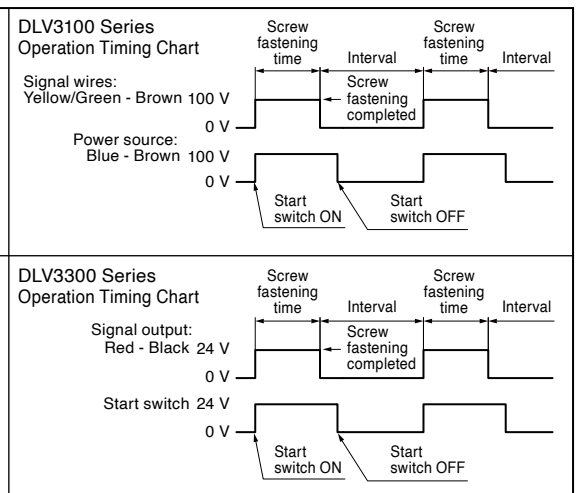
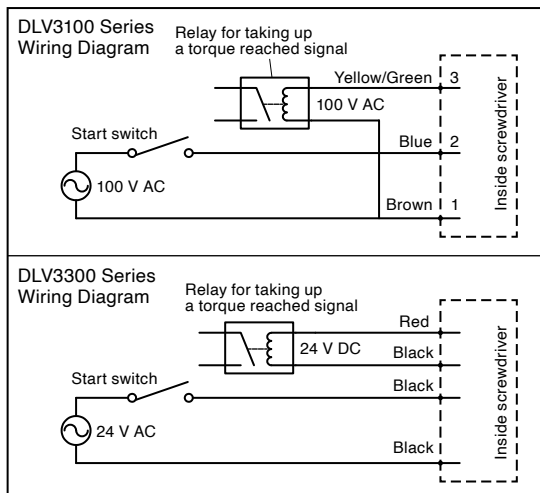

*The torque reached signal is output by detecting the voltage applied to the motor. Please refer to the instruction manual for details.



Torque Checker

Model **DLT1173A/DLT1673A/DLT1973A Series**

Accessories

Features

Maintaining high assembly quality with ease

- Measured data is stored even after the power is turned off, preventing any data loss
 - Energy saving type with AUTO POWER OFF function (Power is automatically turned off when left unused for 10 minutes)
 - A program designed for uploading the data stored in the "delvo" torque checkers to a computer is available to download free from the Nitto Kohki website www.nitto-kohki.co.jp/e/prd/delvo/software/
- Use a cable (USB Type-B) available on the market to connect to a PC.



Specifications

Model	DLT1173A	DLT1673A	DLT1973A
Measurement Range (Nm[lbf·in])	0.015 to 1.500 [0.13 to 13.3]	0.15 to 10.00 [1.33 to 88.5]	4.00 to 12.00 [35.4 to 106.2]
Calibration Precision	Within ± 0.5% (Full Scale)	Within ± 0.5% (Full Scale)	Within ± 0.5% (Full Scale)
Display	4-digit digital display (Single-line)	Data sampling: 1000 times/sec.	Display rate: 12 times/sec.
Measuring Unit	kgf · cm, Nm, lbf · in (selectable)		
Data Memory	800 pieces of data		
Measuring Direction	CW and CCW		
Measuring Mode	3 modes: PD-TR-PP		
Auto Power Off	Power off if left untouched for 10 minutes		
External Output	As per USB output Mitsutoyo Digimatic		
Analog Output	Approx. 1.5 V max.	Approx. 1.0 V max.	Approx. 1.1 V max.
	No zero offset; identical waveforms produced in PP, PD, and TR modes		
Continuous Operation Time	20 hours		
External Dimensions (mm)	W160 × D110 × H47		W200 × D112 × H48.5
(inch)	[W6.3" × D4.33" × H1.85"]		[W7.9" × D4.41" × H1.89"]
Mass (g [lbs])	1100 [2.43]		1400 [3.09]
Rechargeable Battery	Nickel metal hydride battery		
Charger Type	DLE1833A		
Input Voltage for Charger	100 - 240 V AC, 50/60 Hz		
Charging Time	4 hours		
Standard Accessories	• Screw Joint (DLW4430)	• Bit Joint (DLW4360) • Spring for Joint (DLW4660)	• Soft Joint (DLW4000)

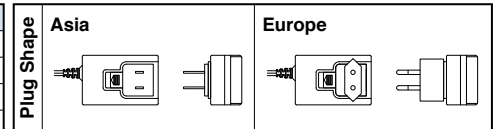

Selection of Torque Checker

DLT1173A	DLT1673A	DLT1973A
DLV3300*1	DLV7500/DLV8500	DLV70A
DLV5700	DLV3100*2	DLV70S
DLV5800	DLV30A/DLV45A	DLV70A (For automation)
DLV7300	DLV30S/DLV45S	
DLV7000	DLV16	
DLV8000	DLV7104	
DLV7400A	DLV8104/DLV8204	
DLV02	DLV30A/DLV45A (For automation)	
DLV12	DLV45C	
DLV04C		
DLV10C		

- *1: A reversible screwdriver is required to loosen the measuring joint.
*2: A reversible screwdriver is required to loosen the measuring joint. Screw joint is required.

Optional Accessories

	Model	Part No.	Shape	Torque Range	DLT1173A	DLT1673A	DLT1973A
Bit Joint	DLW4330	TD03305	OD 4 mm [0.16"] type	0.015 to 0.25 Nm [0.13 to 2.2 lbf·in]	○	—	—
	DLW4340	TD03306	OD 4 mm [0.16"] type	0.015 to 1.5 Nm [0.13 to 13.3 lbf·in]	○	○	—
	DLW4350	TD03307	Hex 5 [0.2"] and Hex 6.35 [1/4"] types	0.015 to 1.5 Nm [0.13 to 13.3 lbf·in]	○	○	—
	DLW4360	TD03308	Hex 5 [0.2"] and Hex 6.35 [1/4"] types	0.15 to 6.5 Nm [1.3 to 57.5 lbf·in]	—	◎	—
Screw Joint	DLW4430	TD03309	screw type (Bit size No.2)	0.015 to 1.5 Nm [0.13 to 13.3 lbf·in]	◎	○	—
	DLW4530	TD03310	screw type (Bit size No.2)	0.15 to 5.0 Nm [1.3 to 44.3 lbf·in]	—	○	—
Soft Joint	DLW4000	TD04123	Hex 13 [0.51"] type (Hex. head bolt)	4.0 to 12.0 Nm [35.4 to 106.2 lbf·in]	—	○*	◎
Hard Joint	DLW4040	TD04124	Hex 13 [0.51"] type (Hex. head bolt)	0.15 to 12.0 Nm [1.3 to 106.2 lbf·in]	—	○*	○
Spring	DLW4660	TV03826	Spring for DLW4340, 4350, 4430	-	○	◎	—

◎ : Standard accessories ○ : Available as option — : Unsupported *DLW4000 and DLW4040 must be used at 10 Nm[44.3 lbf·in] or less.

Joint



Optional Accessories for Joint

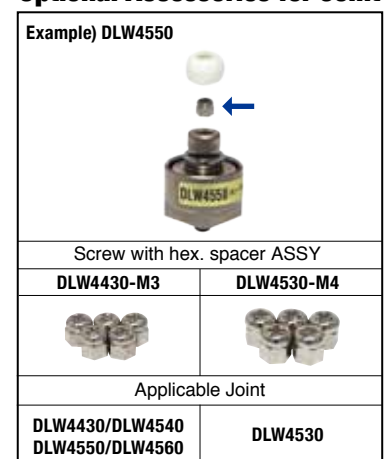

Screw Joint for "delvo" Brushless Type C series

Screw Joint	Model	Application	Applicable Screwdriver		
			DLV04C	DLV10C	DLV45C
DLW4040 ³ DLW4050 ⁴ DLW4540 DLW4550 DLW4560	DLW4040	HARD fastening setting	—	—	○
	DLW4050	HARD fastening setting	—	—	○
DLW4540 DLW4550 DLW4560	DLW4540	SOFT fastening setting	○	—	—
	DLW4550	SOFT fastening setting	—	○	—
DLW4560	HARD fastening setting	○	○	—	

*All joints are for forward rotation only.

*3: Bit (NK35BN 13×19×10×75) for measurement is sold separately.

*4: Bit (NK35BN 13×19×10×75) for measurement is a standard accessory.

*Contains 5 pcs per set.

NK BIT

■ For DLV7400A/DLV5700/DLV5800/DLV7300/DLV7000/
DLV8000/DLV3300 series

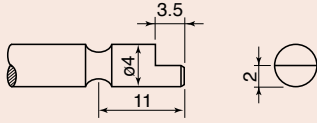

■ For DLV3100/A(DLV30A) series

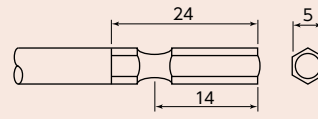

OD 4 mm Shank

Unit: mm

Model	Part No.	Size		Dimensions	
		No. x d x L			
Phillips NK4D	TD20009	00	2	44	
	TD20010		2	64	
	TD20021		1.8	44	
	TD20022	0	1.8	64	
	TD20029		2.5	44	
	TD20030		2.5	64	
	TD20037	1	3	44	
	TD20038		3	64	
	TD20039		4	44	
	TD20040	2	4	64	
	TD20047		4	44	
	TD20048		4	64	
TD20050	3	6	44		
Model	Part No.	W x T x L		Dimensions	
Plain Slot NK4DM	TD20051	2	0.3	44	
	TD20052	2.5	0.3		
	TD20053	3	0.4		
	TD20054	4	0.5		
	TD20055	5	0.65		
Model	Part No.	H x L		Dimensions	
Hexagon Head NK4DX	TD20056	1.5	44		
	TD20057	2			
	TD20058	2.5			
	TD20059	3			
	TD20060	4			
Model	Part No.	H x d x L		Dimensions	
Hex Socket NK4DB	TD20064	4	6	44	
	TD20065	4.5	7		
	TD20066	5	7		
	TD20067	5.5	8		

*Contains 10 pcs of bits per set.

OD 5 mm Hex. Shank

Unit: mm

Model	Part No.	Size		Dimensions			
		No. x d x L					
Phillips NK31	TD20193	1	4	70			
	TD20194		4	100			
	TD20196		5	70			
	TD20197		5	100			
	TD20200		6	70			
	TD20201		6	100			
	TD20207	2	4	70			
	TD20208		4	100			
	TD20210		5	70			
	TD20211		5	100			
	TD20214		6	70			
	TD20215		6	100			
	Model		Part No.	No. x L		Dimensions	
	Phillips NK16		TD20224	1		70	
			TD20225			100	
TD20232		2	70				
TD20233			100				
TD20235			150				
Model	Part No.	H x d x L		Dimensions			
Hexagon Head NK31X	TD20254	2	4	70			
	Part No.	H x L					
	TD20256	2.5	70				
	TD20258	3					
	TD20260	4					
	TD20262	5					
Model	Part No.	H x D x d x L		Dimensions			
Hex Socket NK31B	TD20272	5.5	9	4	70		
	TD20274	6	10	4.5	70		
	TD20276	7	11	5.5	70		
	TD20277	7	11	5.5	100		
	TD20278	8	13	6	70		
	TD20279	8	13	6	100		
	TD20282	10	16	8	70		
TD20283	10	16	8	100			

*Contains 10 pcs of bits per set.

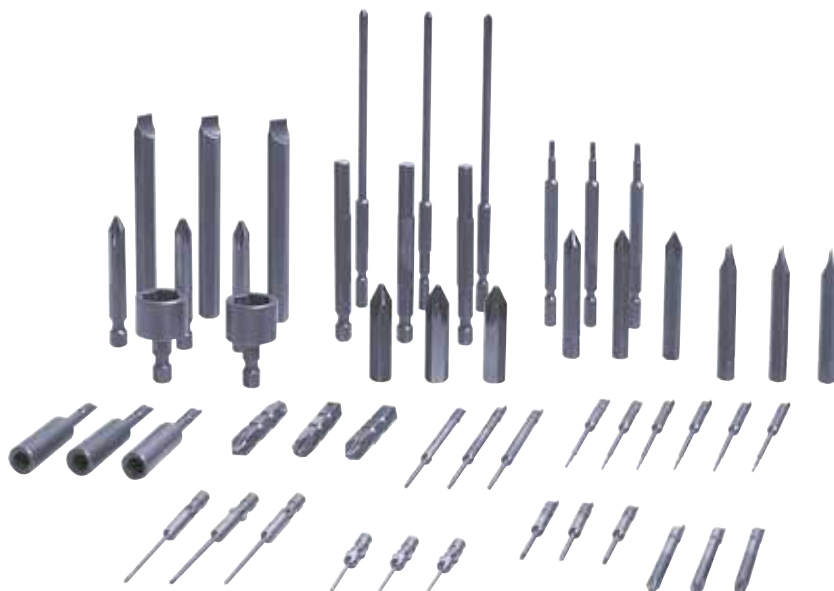

NK BIT

■ For DLV7500/DLV8500/DLV02/DLV12/DLV16
 A(DLV30A/DLV45A/DLV70A) series
 S(DLV30S/DLV45S/DLV70S) series
 C(DLV04C/DLV10C, DLV45C) series

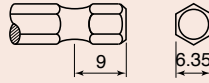

OD 6.35 mm Hex. Shank

Unit: mm

Model	Part No.	Size			Dimensions	
		No. x	d	L		
Phillips NK35	TD20306	1	4	75		
	TD20307			100		
	TD20308			50		
	TD20309			75		
	TD20310			100		
	TD20311			120		
	TD20312			150		
	TD20313	200				
	TD20316	2	4	50		
	TD20317			75		
	TD20319			50		
	TD20320			75		
	TD20321			100		
	TD20322			120		
	TD20323			150		
	TD20324	3	7	200		
	TD20327			50		
	TD20328			75		
	TD20329			100		
	TD20330			120		
TD20331	150					
TD20332	200					
Model	Part No.	No. x	d	L	Dimensions	
Phillips NK36	TD20335	0	3.8	50		
	TD20336	1				
	TD20337	2				
	TD20338	4.5				
Model	Part No.	No. x	L	Dimensions		
Phillips NK15	TD20354	1	1	50		
	TD20355			75		
	TD20356			100		
	TD20357			120		
	TD20358			150		
	TD20359	200				
	TD20362	2	2	50		
	TD20363			75		
	TD20364			100		
	TD20366			150		
	TD20367			200		
	TD20371	3	3	75		
	TD20372			100		
	TD20374			150		
	TD20375			200		
Model	Part No.			W x T	L	Dimensions
Plain Slot NK35M	TD20378	7	0.9	50		
	TD20379			75		
	TD20380			100		
Model	Part No.	H x d	L	Dimensions		
Hexagon Head NK35X	TD20382	1.27	3	70		
	TD20385	1.5				
	TD20388	2				
	Part No.	H x L				
	TD20391	2.5	70	50		
	TD20394	3				
	TD20397	4				
	TD20400	5				
TD20404	6					
Model	Part No.	H x D	d x d	L	Dimensions	
Hex Socket NK35BN	TD20442	10	16	8		
	TD20443					75
	TD20457	13	19	10		75
	TD20458					100

*If Bits other than the above are required, please contact Nitto Kohki or our distributors.
 *Contains 10 pcs of bits per set.

Vacuum Pickups and Sleeves

Screwdriver series		Vacuum Pickup		Included Sleeve (Standard accessory)		
		Model	Part No.	Model	Q'tty	
DLV7000/DLV8000/DLV3300		DLP6500	TD00343	DLS2124/DLS2127/DLS2130	1 piece each	
DLV7400A/DLV5700/DLV5800		DLP5300	TD04342	DLS2120/DLS2124		
DLV7313		DLP7100	TD00345	DLS2122/DLS2124/DLS2127		
DLV7323/DLV7333		For Ø4 mm	DLP7200	TD00346		
		For HEX. 6.35 mm (1/4")	DLP7300	TD00347		
DLV30A (For automation)		For HEX. 5 mm (M3, M4)	DLP7401-J	TD09525		DLS3223/DLS3225
A series, S series, C series (DLV45C) DLV7104/DLV8104/DLV8204		For HEX. 6.35 mm (1/4") (M5, M6)	DLP7401-K	TD09526		DLS4220/DLS4221
C series (DLV04C, DLV10C)		For Ø4 mm For HEX. 6.35 mm (1/4")	DLP6600/DLP6610 DLP6640/DLP6650	TD08748/TD08751 TD08804/TD08805		DLS2124/DLS2127/DLS2134 DLS4225/DLS4227

*The applicable tube outer diameter for each vacuum pickup is 6 mm.

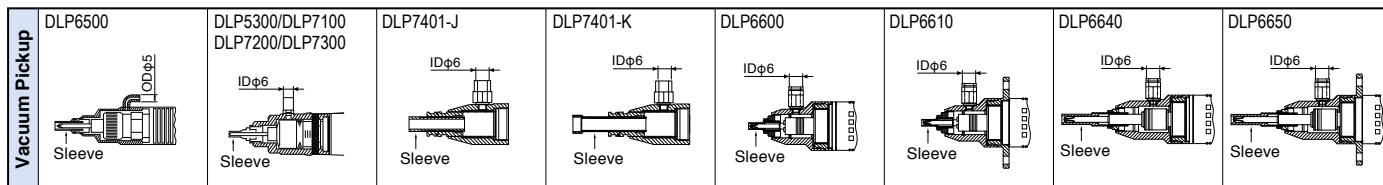

*The applicable tube outer diameter for each vacuum pickup is 6 mm.

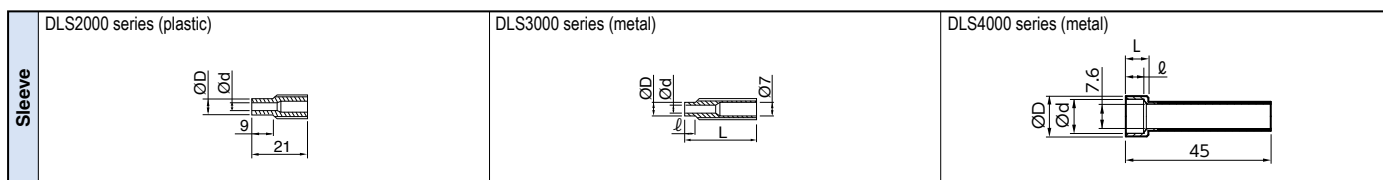

DLS2000 series For Ø4 mm

Sleeve					Bit	
Model	Part No.	Color	ød mm (inch)	øD mm (inch)	Model	Size (No.xd×L) (+)
DLS2120	TD00348	Red	2 (0.08)	3.5 (0.14)	NK4D	No. 0 × 1.8 × 44
DLS2121	TD00349	Purple	2.2 (0.09)			
DLS2122	TD00350	Green	2.5 (0.1)			
DLS2123	TD00351	Yellow	2.7 (0.11)			
DLS2124	TD00352	Pink	3.1 (0.12)	4.5 (0.18)		No. 0 × 2.5 × 44
DLS2125	TD00353	Brown	3.3 (0.13)			
DLS2126	TD00354	Blue	3.5 (0.14)			
DLS2127	TD00355	Black	3.7 (0.15)			
DLS2128	TD00356	Red	4 (0.16)	5.5 (0.22)		No. 1 × 3 × 44
DLS2129	TD00357	Purple	4.2 (0.17)			
DLS2130	TD00358	Green	4.5 (0.18)	6.5 (0.26)	No. 1 × 4 × 44	
DLS2131	TD00359	Yellow	4.7 (0.19)			
DLS2132	TD00360	Pink	5.1 (0.2)	7 (0.28)	No. 2 × 4 × 44	
DLS2133	TD00361	Brown	5.3 (0.21)			
DLS2134	TD00362	Blue	5.6 (0.22)			
DLS2135	TD00363	Black	6.1 (0.24)			

DLS3000 series For HEX. 5 mm

Sleeve						Bit	
Model	Part No.	ød mm (inch)	øD mm (inch)	ℓ mm (inch)	L mm (inch)	Model	Size (No.xd×L) (+)
DLS3222	TD00364	5.6 (0.22)	7 (0.28)	5 (0.2)	34 (1.34)	NK31	No. 1 × 5 × 70
DLS3223	TD05024	6.1 (0.24)	9 (0.35)	6 (0.24)			
DLS3224	TD00365	6.4 (0.25)					
DLS3225	TD00366	7.1 (0.28)					
DLS3232*	TD07410	9.1 (0.36)	11 (0.43)	6 (0.24)	65 (2.56)	NK31	No. 1 × 4 × 100
DLS3226	TD00367	4.6 (0.18)	7 (0.28)	18 (0.71)			
DLS3227	TD00368	5.1 (0.2)					
DLS3228	TD00369	5.6 (0.22)					
DLS3229	TD00370	6.1 (0.24)	9 (0.35)				
DLS3230	TD00371	6.4 (0.25)					
DLS3231	TD00372	7.1 (0.28)			No. 2 × 5 × 100		
							No. 2 × 6 × 100

*Made-to-order

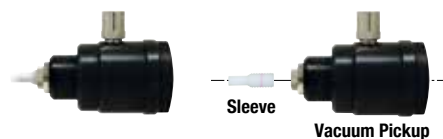

DLS4000 series For HEX. 6.35 mm (1/4")

Sleeve						Bit*2		Type	
Model	Part No.	ød mm (inch)	øD mm (inch)	ℓ mm (inch)	L mm (inch)	Model	Size (No.xd×L) (+)		
DLS4220	TD08001	9.1 (0.36)	11 (0.43)	5 (0.2)	6 (0.24)	NK35	No. 2 × 7 × 75		
DLS4221	TD08002	10.6 (0.42)	12.5 (0.49)	5.5 (0.22)	7 (0.28)				
DLS4222 ¹	TD07850	8 (0.31)	11 (0.43)	5.3 (0.21)	22 (0.87)		—	A	
DLS4223 ¹	TD07851	8.2 (0.32)	10 (0.39)	5 (0.2)	6 (0.24)				
DLS4224 ¹	TD07852	6.8 (0.27)	9 (0.35)	—	—		25 (0.98)	—	
DLS4225	TD09344	4.6 (0.18)	7 (0.28)	20 (0.79)	—				—
DLS4226	TD09617	5.1 (0.2)							
DLS4227	TD09345	5.6 (0.22)							
DLS4228	TD09618	6.1 (0.24)	9 (0.35)	—	—		—	C	
DLS4229	TD09619	6.4 (0.25)							
DLS4230	TD09620	7.1 (0.28)							

*1 Made-to-order

*2 Select the correct size number that fits your screw head.

[Sleeve selection guideline]
Select a sleeve whose ød is 0.1 to 0.3 mm larger than the diameter of the screw head.
(Please note that this does not apply to some screws.)

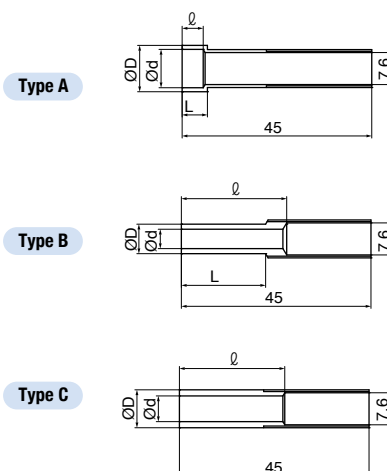

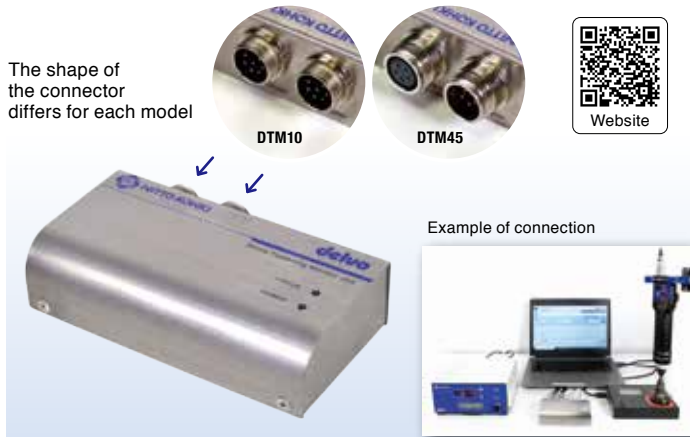

Accessories for "delvo" Brushless Type C Series

Screw Fastening Monitor

Model **DTM10/DTM45**

Features

For traceability management!
Outputs torque value from a screwdriver (converted value)

- Converts motor current to torque value at torque-up
- Sends data to external devices such as computers and PLCs
- The free dedicated software is available on Nitto Kohki website
- OK(Pass)/NG(Fail) can be judged by the output torque (converted value) and screw fastening time

Specifications

Model		DTM10	DTM45
Connectable models	Electric screwdriver	DLV04C10L-A <input type="checkbox"/> DLV10C10L-A <input type="checkbox"/> □ : Y,Z	DLV45C12L-A <input type="checkbox"/> DLV45C12P-A <input type="checkbox"/> □ : Y,Z
	Controller	DCC0101X-AZ	DCC0241X-AZ
Transmission data			
Operation channel/Converted current value*			
		Screw fastening time	Screw fastening time/Rotation signal
Communication method			
RS-232C (When connecting to a PC, please use a conversion adapter available on the market.)			
Standard Accessories		• Connection cord DLW9075 (2 m) • Rubber feet	• Connection cord DLW9078 (2 m) • Rubber feet

*Converted current value: Motor current value at torque-up converted to a value between 0 to 4095

Optional Accessory

RS-232C

Specifications: D-SUB 9-pin (female)
Screw: Inch female screw (#4-40)

RS-232C
Communication Cable 3 m
DLW9092

Connection diagram

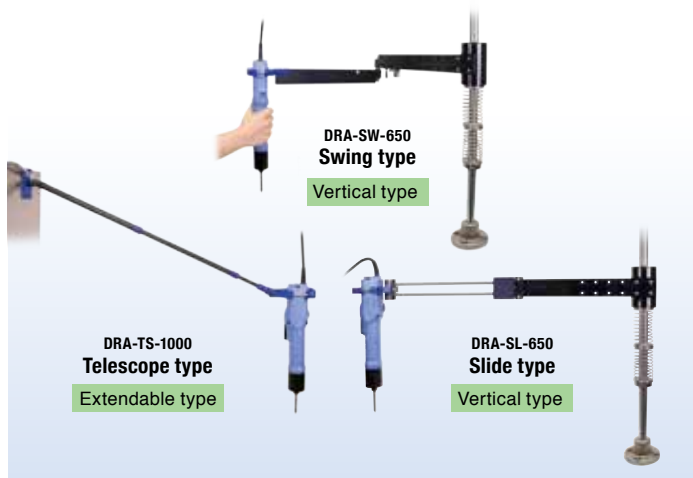

Accessories

Torque Reaction Arm

Model **DRA-SW-650/DRA-SL-650**
DRA-TS-1000

Features

For reducing reaction force to an operator and improving quality of screw fastening work!

- Improves operation by reducing reaction force
- Vertical tightening to the workpiece improves quality of the work*
- Low profile type for convenient installation*

*except DRA-TS-1000

Specifications

Model		DRA-SW-650 (Swing type)	DRA-SL-650 (Slide type)
Total height	mm[in]	550 [21.65"]	
Mass	kg[lbs]	4.2 [9.26]	
Maximum operating radius ^{*1}	mm[in]	R650 [R25.59"] (When arm angle is 30°)	R400 to R650 [R15.75" to R25.59"]
Vertical stroke ^{*2}	mm[in]	100 [3.94"] (150 [5.91"] ^{*3})	
Amount of slide	mm[in]	—	250 [9.84"]
Applicable outer diameter of screwdriver	mm[in]	30 to 52 dia. [1.18" to 2.05"]	
Maximum screwdriver weight	kg[lbs]	1.0 [2.2]	
Applicable models		All models of "delvo"	

Model		DRA-TS-1000 (Telescope type) ^{*4}
Operation range (Arm length)	mm[in]	503 to 1000 [19.8" to 39.4"] (503 to 1123 [19.8" to 44.2"])
Mass	kg[lbs]	0.47 [1.04]
Applicable outer diameter of screwdriver	mm[in]	30 to 52 dia. [1.18" to 2.05"]
Applicable models		All models of "delvo"

^{*1} When an electric screwdriver of 52 mm dia. is attached ^{*2} When DLV70A is attached
^{*3} When the stroke extension ASSY is used ^{*4} Use a tool balancer to hang the screwdriver.

Optional Accessories

[Stroke extension ASSY]

Model: **DRW1000**
Part Number: TD09755

Parts included:
 ① Push spring
 ② Spring guide B

*Before extension

Vacuum Pump DLP2500 series

Accessories



Electric Screwdrivers can be used with Vacuum Pump and Vacuum Pickup. The sleeve of Vacuum Pickup sucks the screw and holds it on the bit, enabling the operator to pick it up with the tool itself, thus improving operational efficiency and operator's productivity.

Model	DLP2530	DLP2570
Features	Standard	With CE mark
Power Source	100 V AC, 50/60 Hz	230 V AC, 50/60 Hz
Power Consumption (W)	30(50 Hz), 26(60 Hz)	
Achievable Vacuum (kPa)	-21.3	
Flow Rate (at Outlet) (L/min)	24(50 Hz), 26(60 Hz)	
Screw Size (mm)	4 or less	
Mass (g [lbs])	3800 [8.38]	

Torque Adjustment Ring Cover

Accessories



DLW5201

Fits over torque adjustment ring cover to minimize tampering or accidental turning once the torque is set.

Model	Part No.	Applicable Screwdriver	Material
DLW5201	TD05639	DLV30A (Transformerless type)	Plastic
DLW5202	TD08486	DLV45S, DLV70S and DLV45A, DLV70A	Aluminum
DLW5203	TD09222	DLV30S and DLV30A (Low voltage type)	Plastic (ESD)
DLW5300	TD00332	DLV7301, DLV7000, DLV8000 series (for 4 mm bit)	Aluminum
DLW5400	TD01883	DLV7301 series (for 6.35 mm bit)	Aluminum
DLW5500	TD00333	DLV7303 series (for 4 mm & 6.35 mm bit)	Aluminum
DLW5600	TD00334	DLV7500, DLV8500 series	Plastic
DLW5700	TD02875	DLV5700, DLV5800, DLV7400A series	Aluminum
—	TV07315	DLV02SL-BKE, DLV12SL-BKE, DLV16SL-BKE series	Plastic (ESD)
—	TV06787	DLV02SL-CKE, DLV12SL-CKE, DLV16SL-CKE series	Plastic

* As this is a clear plastic cover, torque scale can be seen even after mounted on the screwdriver.

Tool Balancer

Accessories



TW-06R
TW-1R

RW-3
RW-5

Easy to adjust tension by using handle.

Model	TW-06R	TW-1R	RW-3	RW-5
Capacity (g [lbs])	200 to 600 [0.44 to 1.32]	500 to 1500 [1.1 to 3.31]	1000 to 3000 [2.2 to 6.61]	2500 to 5000 [5.51 to 11.02]
Stroke (m [inch])	1.5 [59"]		2 [78.7"]	
Mass (g [lbs])	300 [0.66]		700 [1.54]	900 [1.98]

Pistol Grip DLW2300/DLW2300ESD

Accessories



Easy-to-attach grip suitable for horizontal operation.

Model	Applicable Screwdriver
DLW2300 (Non-ESD)	DLV7104/DLV8104/DLV8204 DLV7500-MKE/DLV8500-MKE DLV30A/DLV45A/DLV70A(Transformerless type) DLV30A/DLV45A/DLV70A(Low voltage, Non-ESD type)
DLW2300ESD	DLV7500-BKE/DLV8500-BKE DLV45C/DLV30S/DLV45S/DLV70S DLV30A/DLV45A/DLV70A (Low voltage, ESD type)

Shaker Box Made of Anti-electrostatic Resin

Accessories

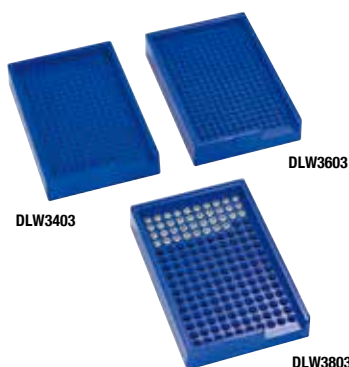

DLW3403

DLW3603

DLW3803

The screws will fall into the heads-up position for easier vacuum or magnetic pickup. The anti-electrostatic resin greatly reduces static build-up and dust attached to the shaker box.

Model	DLW3403	DLW3603	DLW3803
Part No.	TD10096	TD10097	TD10098
Hole Pitch (mm [inch])	6 [0.24"]		8 [0.31"]
Hole Depth (mm [inch])	13.5 [0.53"]		12.5 [0.49"]
No. of Holes	273	273	160
Screw Size (mm)	1.7 to 2	2 to 2.6	3 to 4
External Dimensions	W142 x H25 x D94 (W5.60" x H0.98" x D3.70")		

Torque Reaction Arm

Accessories

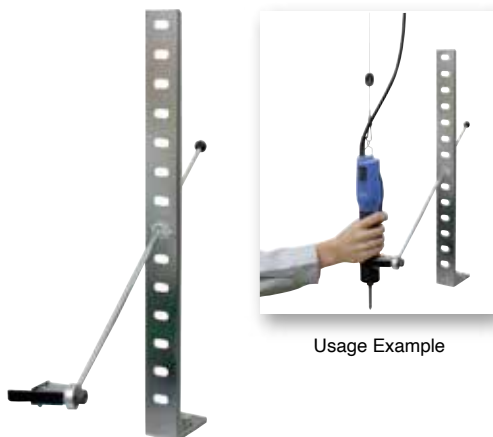

Usage Example

For enhanced productivity and prevention of operator's repetitive motion injury, a torque reaction arm should be used all together.

Part No.	Description	Applicable Screwdriver
TD06180	Torque Reaction Arm	A series(DLV30A/DLV45A/DLV70A) S series(DLV30S/DLV45S/DLV70S)

Optional Cord

Accessories

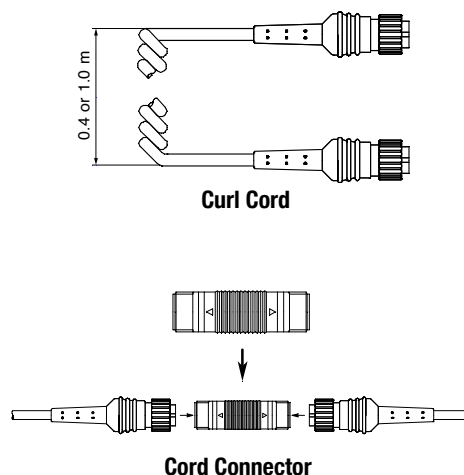

Curl Cord

Cord Connector

Please inquire of the distributor for the price and minimum quantity on each optional cord.

Part No.	Optional Cord	Applied Models	Length (m)
TD02826	5P to 6P Exchange Cord*		0.1
TD02548	Extension Cord For 5P DLW9320	DLV7300 series	3.0
TD10049	Extension Cord For 6P DLW9330		2.0
TD01882	Curl Cord		0.4
TD02820	Curl Cord	DLV7500 DLV8500 series	1.0
TD02438	Cord Connector DLW9100		

* "5P to 6P Exchange Cord" is used to connect "5-prong Screwdriver" to "6-prong Controller".

Angle Attachment

Accessories

For tightening work at right angles.
(for use with lever start type only)



Specifications

Model	DLW9020	DLW9021
Applicable models	Made to order models (Lever start type, Bit type: OD 5 mm Hex. Shank)	DLV7104/DLV7204 Series DLV30S(Lever start type) ^{*1} DLV30A(Lever start type) ^{*1}
Operable torque range	2.0 or less ^{*2}	
Gear ratio	1:1	
Dimension of A (Nm)	Approx. 44.8 (When using 70 mm bit)	Approx. 56 (When using 75 mm bit)
Bit Type (mm)	<p>OD 5 mm Hex. Shank</p>	<p>OD 6.35 mm Hex. Shank</p>

*1: Use with a torque scale of 2 or more.

*2: Using beyond the operable torque range may cause a malfunction.

External Dimensions

(mm)

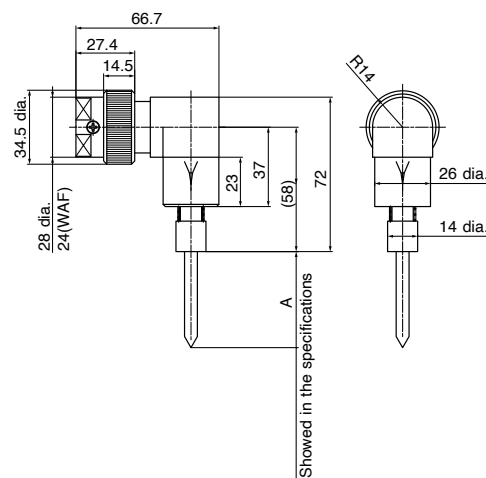

DLV45C12L-AY

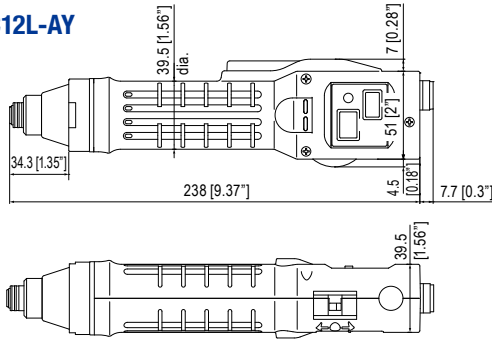

DLV45C12P-AY

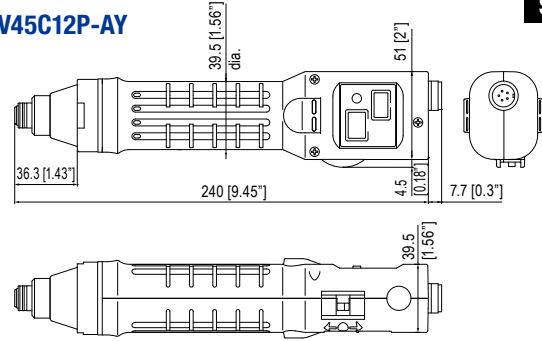

When Flange Coupling DLW9017/DLW9019 is mounted

*When it is mounted on the screwdriver, the hole position of the coupling may differ for each screwdriver.

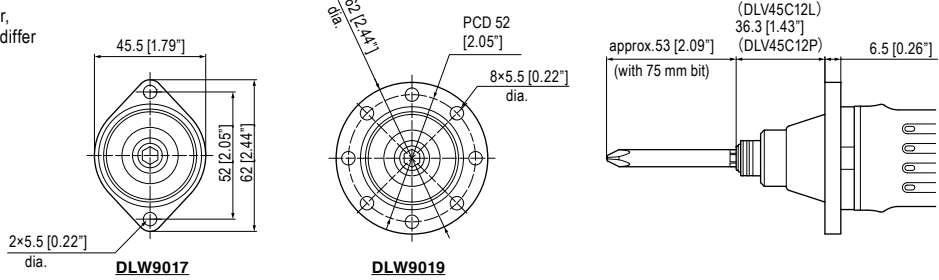

When Flange Coupling and Vacuum Pickup DLP7401-K is mounted

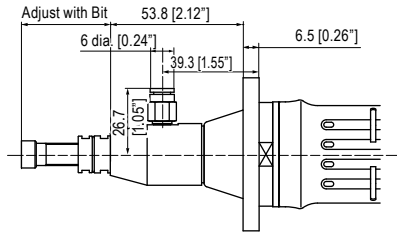

When Vacuum Pickup DLP7401-K is mounted

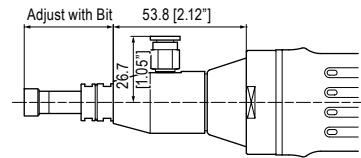

Controller DCC0241X-AZ

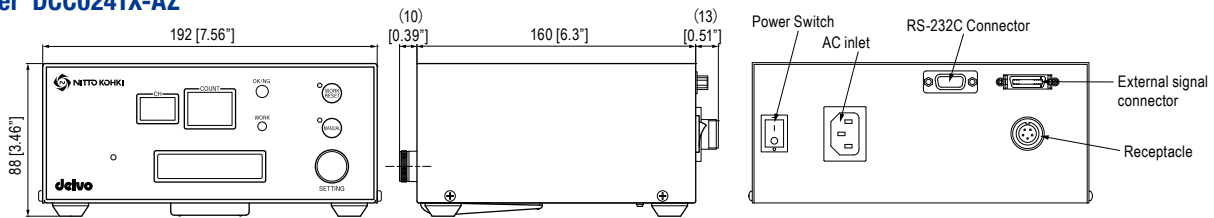

DLV04C/DLV10C ("K" Bit Type)

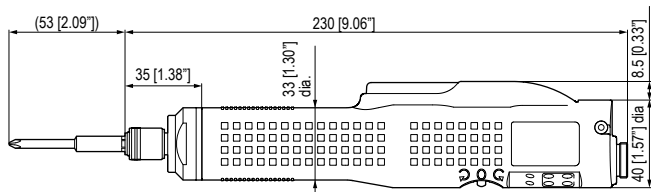

When Flange Coupling DLW9015 is mounted

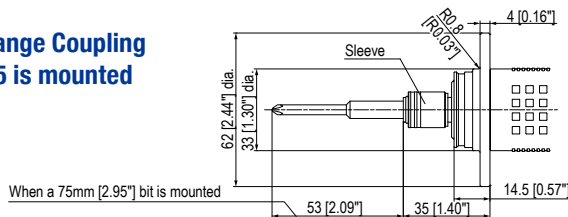

When Flange Coupling and Vacuum Pickup DLP6650 is mounted

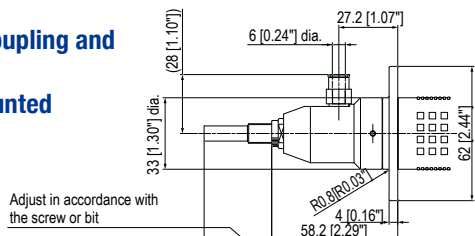

DCC0101X-AZ

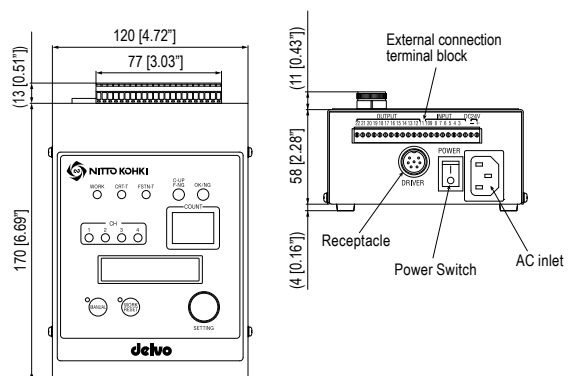

Flange Coupling DLW9015

*When it is mounted on the screwdriver, the hole position of the coupling may differ for each screwdriver.

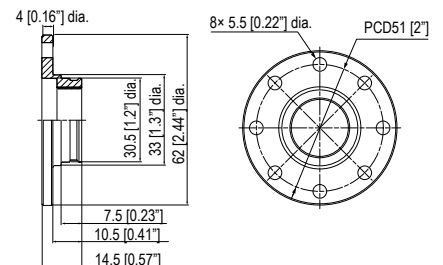

DLV30S06P/DLV30S12P/DLV30S20P

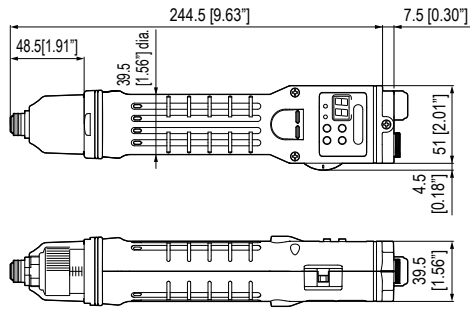

DLV30S06L/DLV30S12L/DLV30S20L

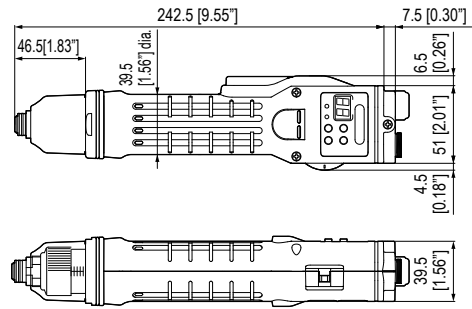

DLV45S06P/DLV45S12P/DLV70S06P

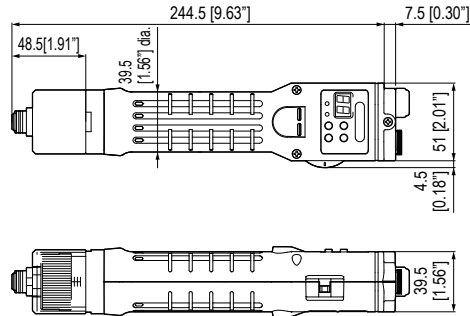

DLV45S06L/DLV45S12L/DLV70S06L

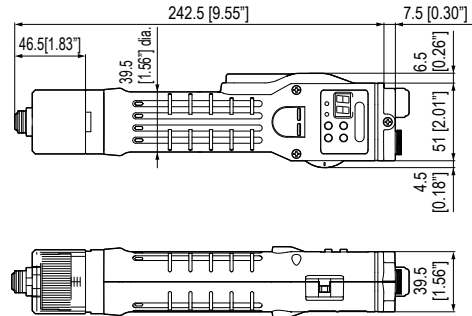

DEA0151N-AZ

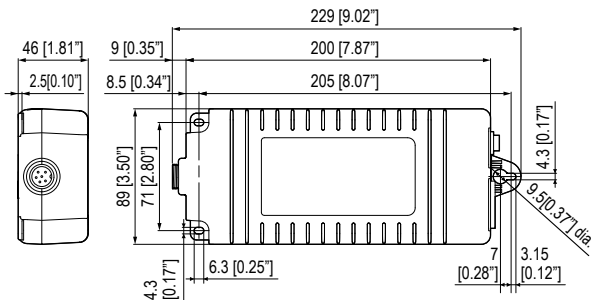

RC1000

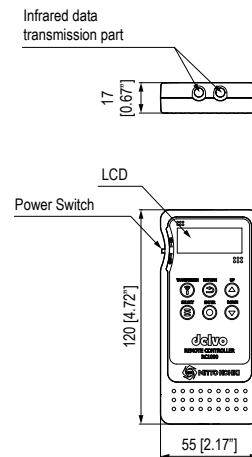

DEA0241N-AZ

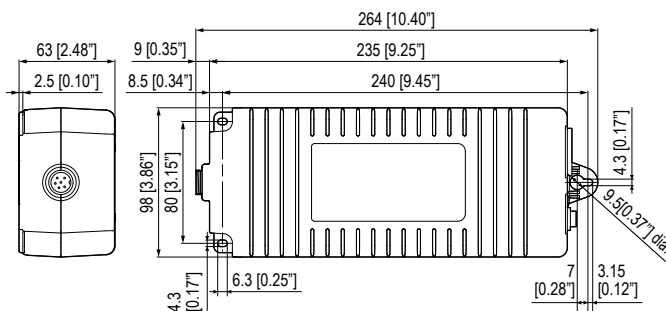

Flange Coupling

DLW9016/DLW9017/DLW9018/DLW9019

DLW9016 (For DLV30), DLW9017 (For DLV45/DLV70)

DLW9018 (For DLV30), DLW9019 (For DLV45/DLV70)

*When it is mounted on the screwdriver, the hole position of the coupling may differ for each screwdriver.

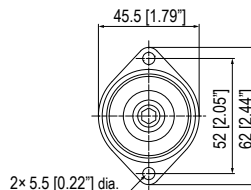

DLW9016/DLW9017

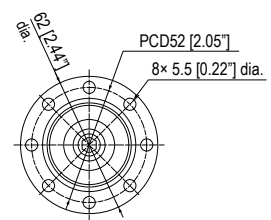

DLW9018/DLW9019

DLV30A06P-AY/DLV30A12P-AY/DLV30A20P-AY

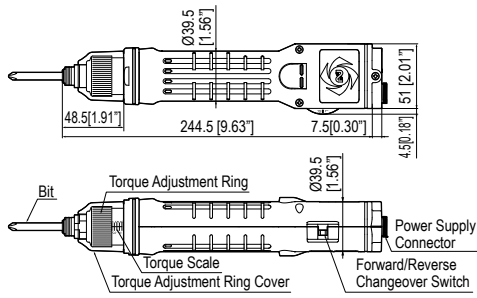

DLV30A06L-AY/DLV30A12L-AY/DLV30A20L-AY

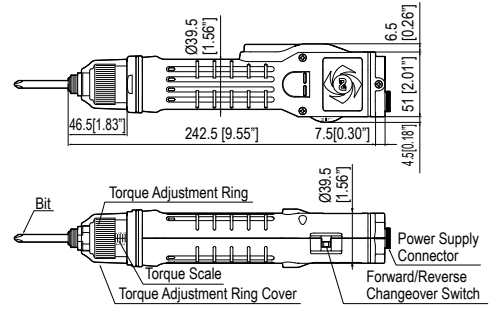

DLV45A06P-AY/DLV45A12P-AY/DLV70A06P-AY

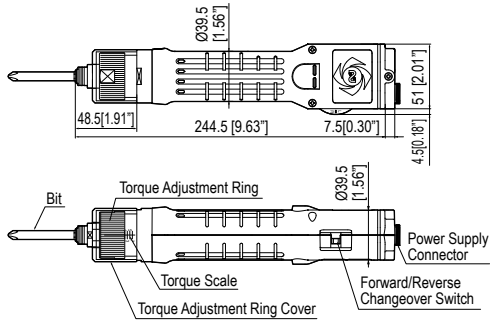

DLV45A06L-AY/DLV45A12L-AY/DLV70A06L-AY

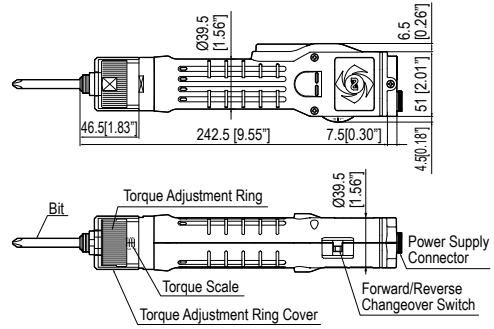

*See page 54 for external dimensions of power supply DEA0151N-AZ and DEA0241N-AZ

DLV30A06P-AS/DLV30A12P-AS/DLV30A20P-AS

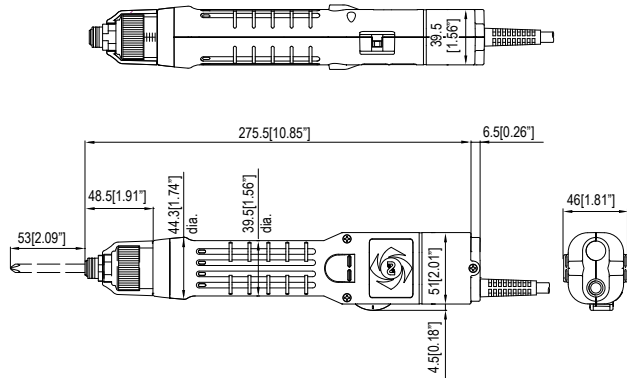

DLV30A06L-AS/DLV30A12L-AS/DLV30A20L-AS

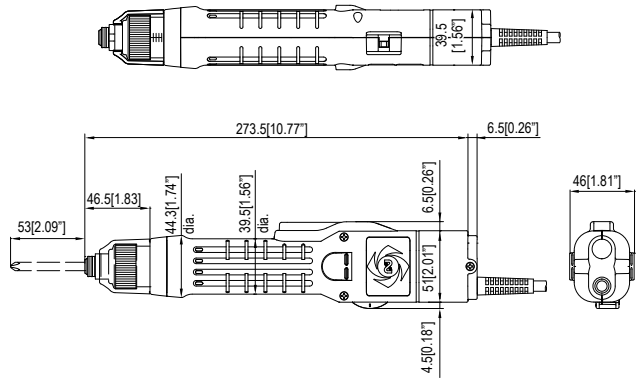

DLV45A06P-AS/DLV45A12P-AS/DLV70A06P-AS

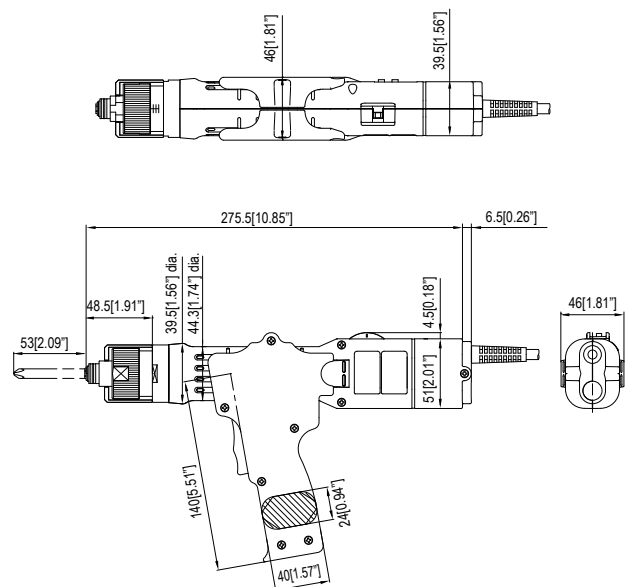

DLV45A06L-AS/DLV45A12L-AS/DLV70A06L-AS

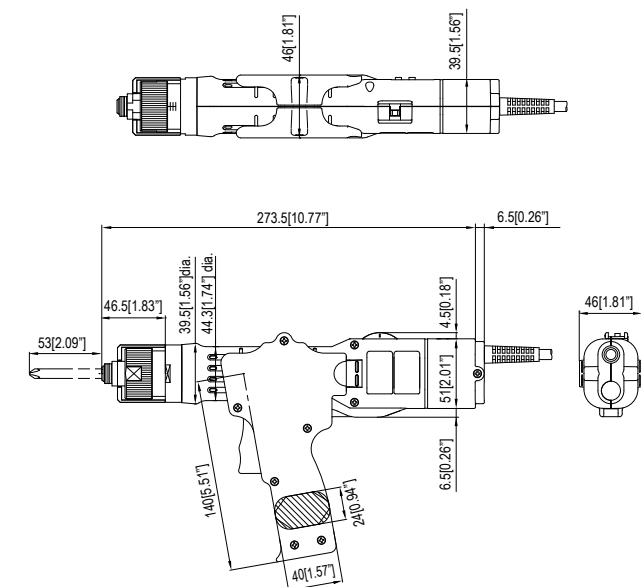

DLC70S-WGB

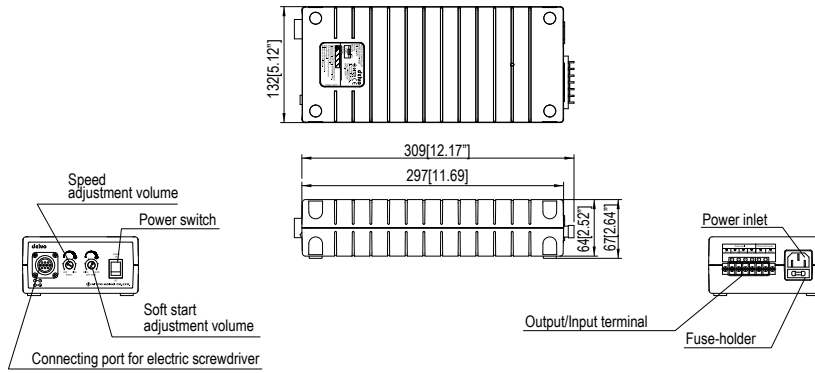

DLR70S-WGB

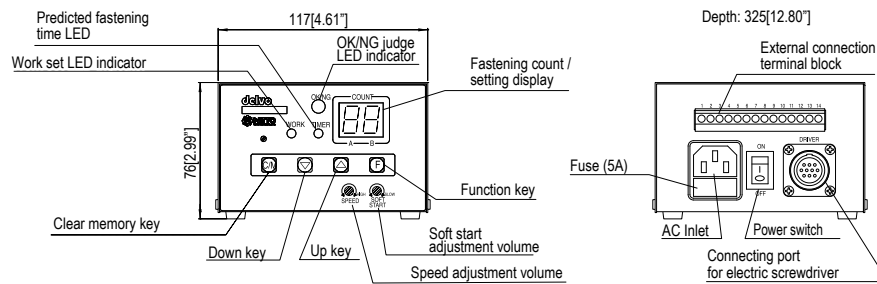

**DLV30A06P-AB/DLV30A12P-AB/DLV30A20P-AB
DLV30A06P-SP(AB)/DLV30A12P-SP(AB)/DLV30A20P-SP(AB)**

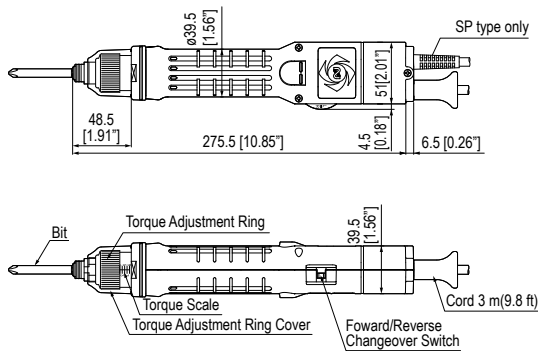

**DLV30A06L-AB/DLV30A12L-AB/DLV30A20L-AB
DLV30A06L-SP(AB)/DLV30A12L-SP(AB)/DLV30A20L-SP(AB)**

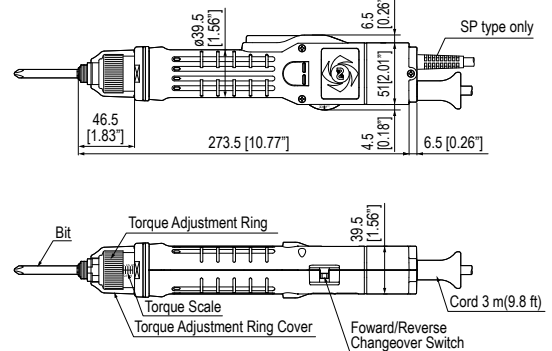

**DLV45A06P-AB/DLV45A12P-AB/DLV70A06P-AB
DLV45A06P-SP(AB)/DLV45A12P-SP(AB)/DLV70A06P-SP(AB)**

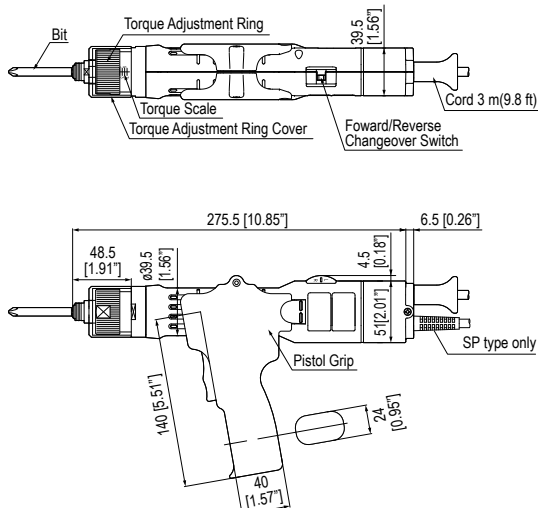

**DLV45A06L-AB/DLV45A12L-AB/DLV70A06L-AB
DLV45A06L-SP(AB)/DLV45A12L-SP(AB)/DLV70A06L-SP(AB)**

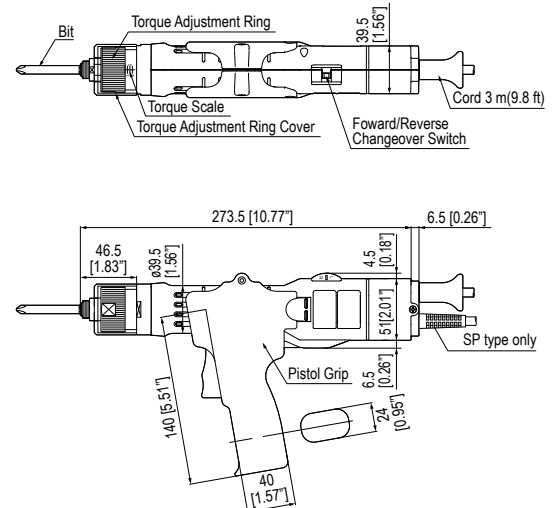

DLV02SL-CKE/DLV12SL-CKE/DLV16SL-CKE

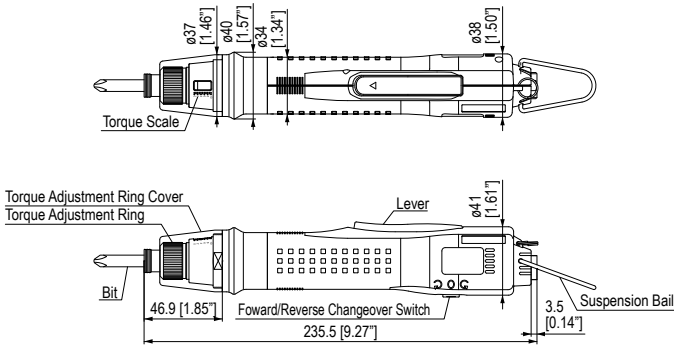

DLC16S-WGB

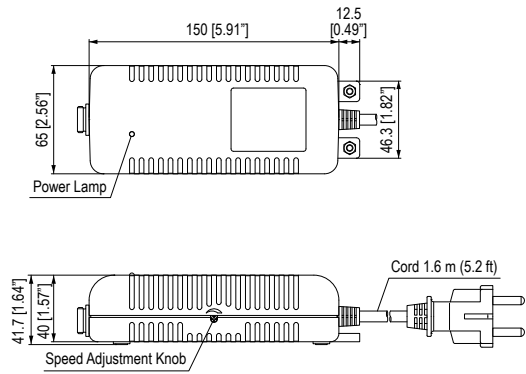

DLV02SL-BKE/DLV12SL-BKE/DLV16SL-BKE

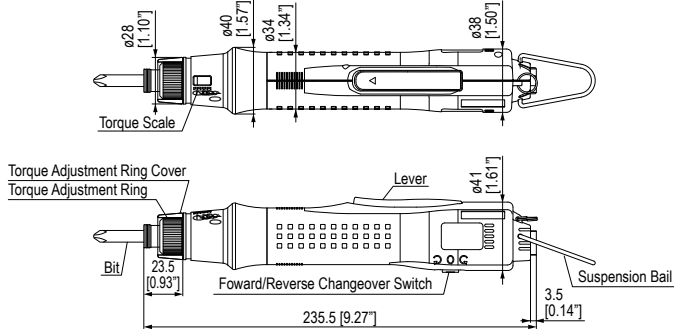

DLV7410A/DLV7410HA/DLV7420A-BME

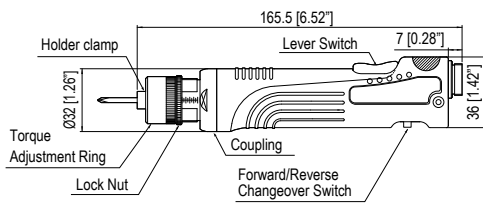

DLV7419A/DLV7419HA/DLV7429A-BME

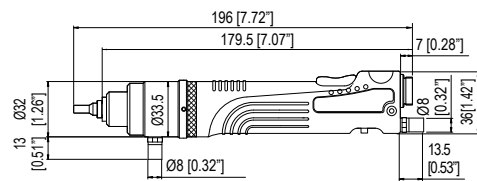

DLC1110

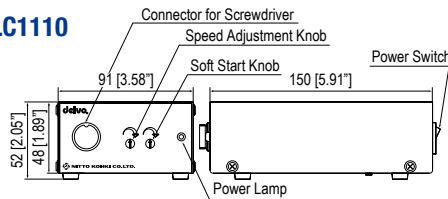

DLV5720/DLV5720H/DLV5740

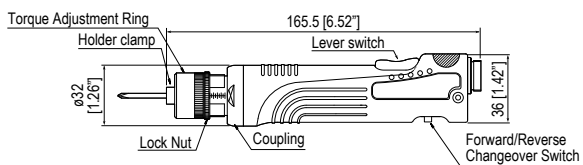

DLV5740H/DLV5750

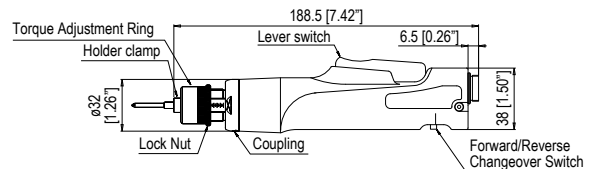

DLC0950

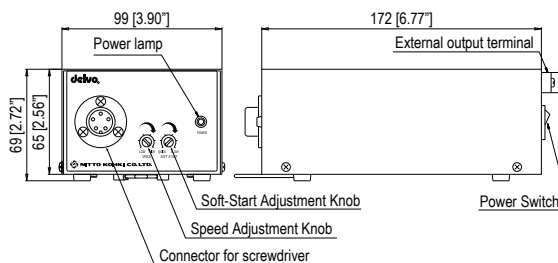

**DLV5820U/DLV5820HU/DLV5840U
DLV5820/DLV5820H/DLV5840**

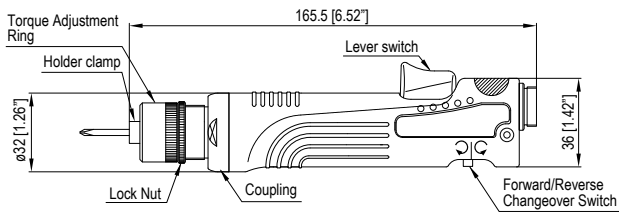

DLC0250E

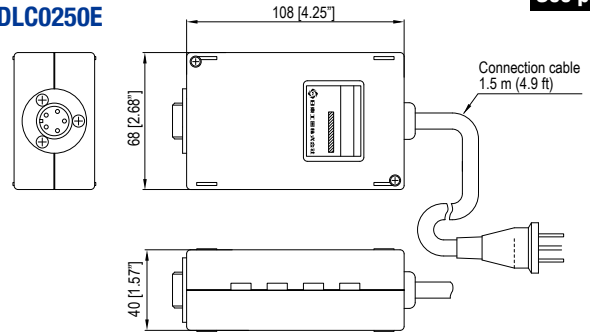

DLC0350

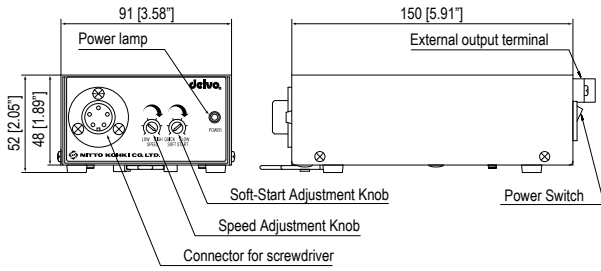

Internal circuit

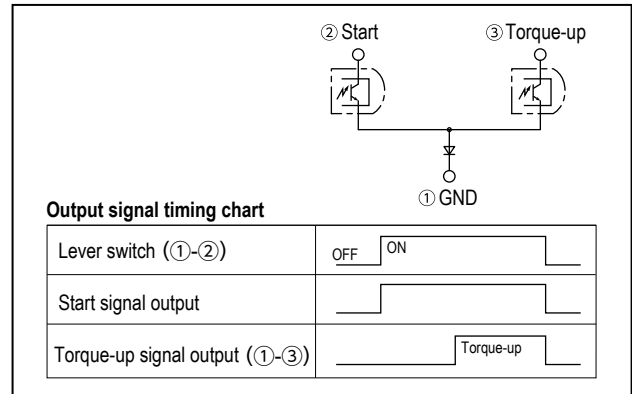

DLV7313/DLV7323/DLV7333

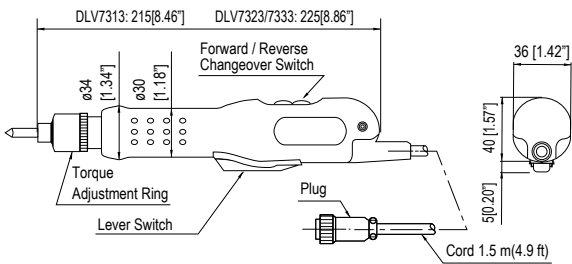

DLV7325/DLV7335

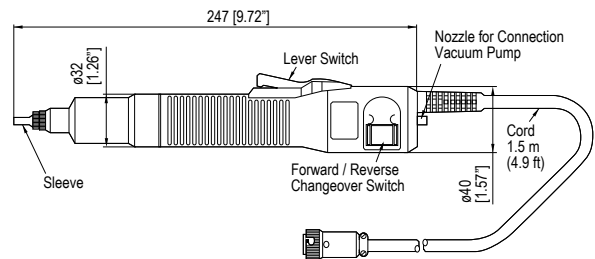

DLC1213A

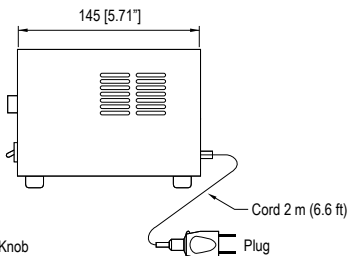
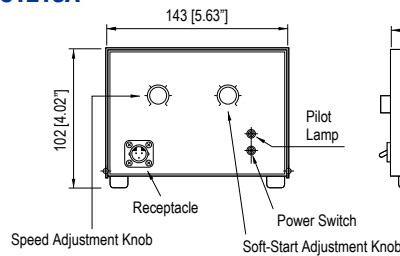

DLV7321/DLV7331/DLV7319/DLV7329/DLV7339/DLV7349

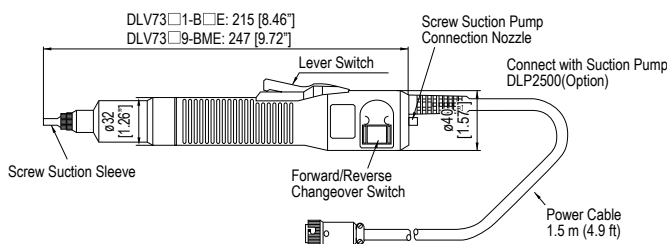

**DLC1213A-ENB/DLC1213A-FEB/
DLC1213A-GGB/DLC1213A-HEB**

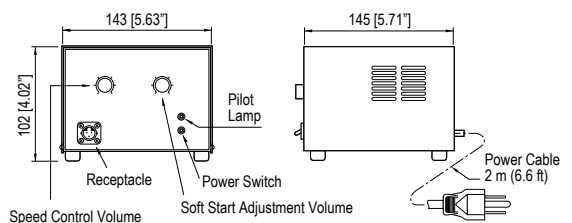

DLV7500 series

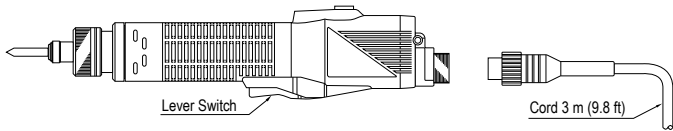

DLV8500 series

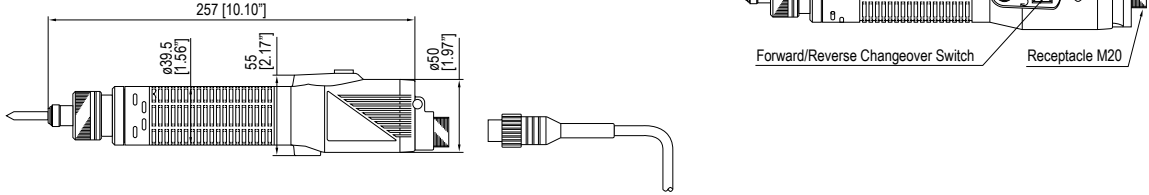

DLC4511-GGB

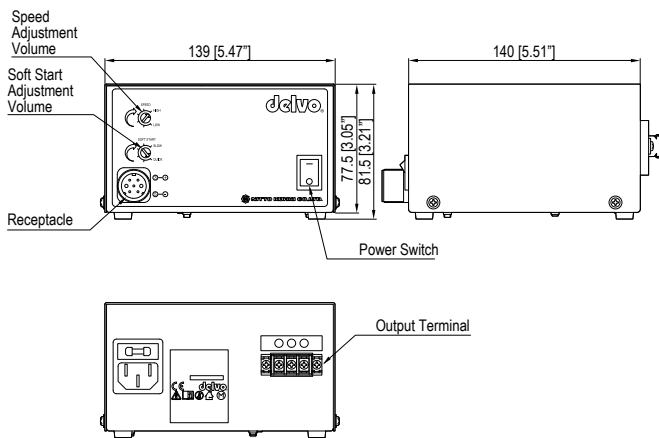

DLR1510-JE

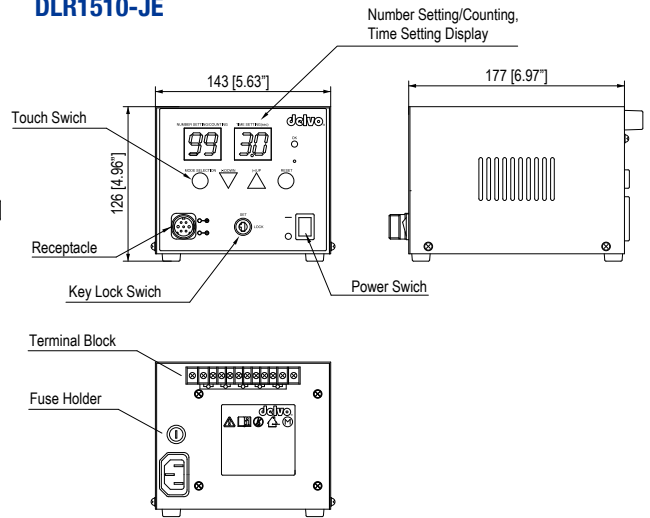

DLV7020/DLV7030/DLV7031

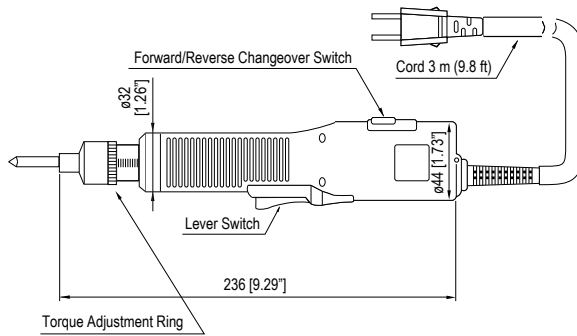

DLV8020/DLV8030/DLV8031

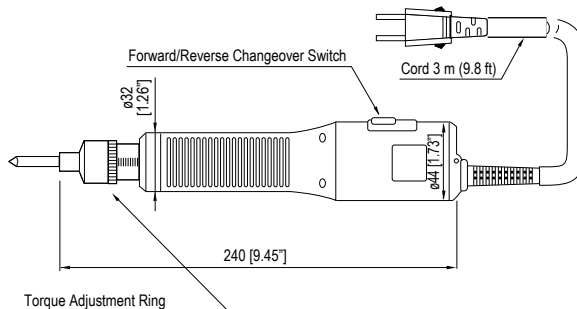

DLV7124/DLV7134/DLV7144

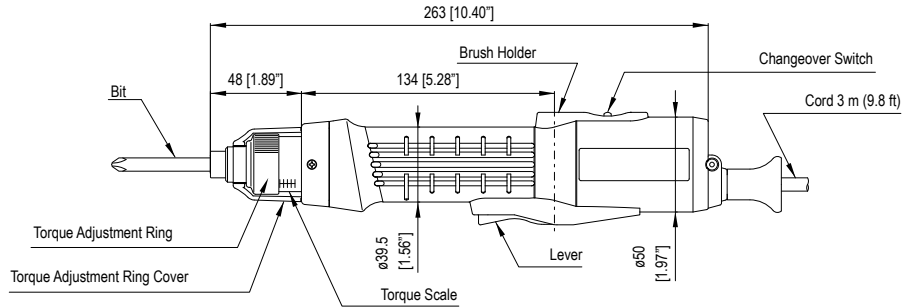

DLV8124/DLV8134/DLV8144/DLV8224/DLV8234/DLV8244

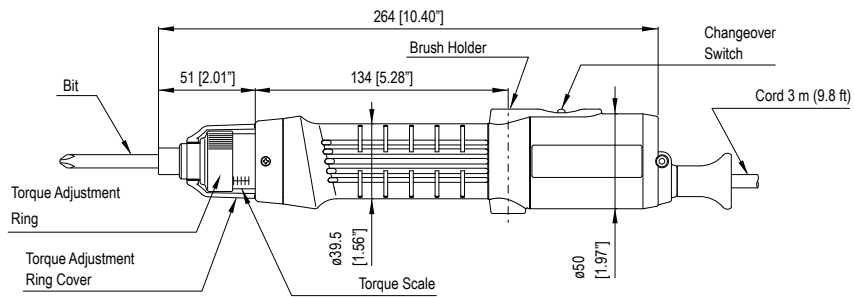

DLV8154

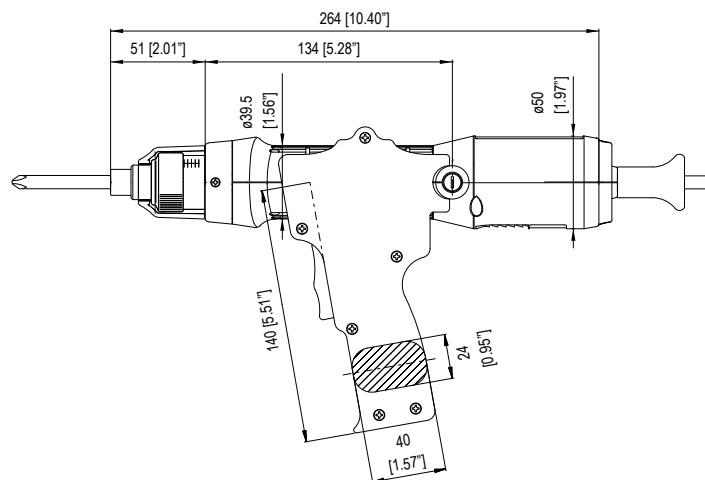

DLR5640-WN

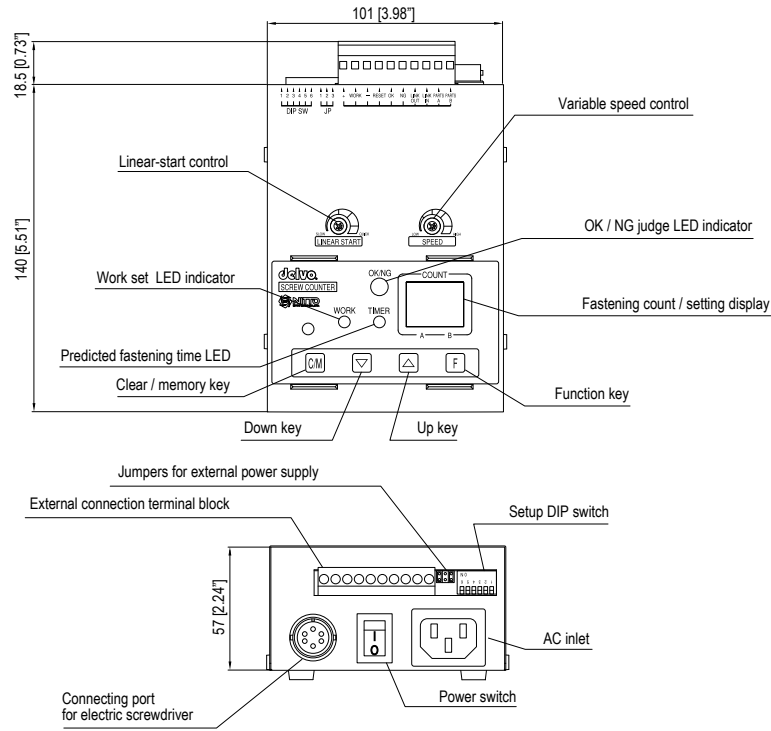

DLR5040A-WE

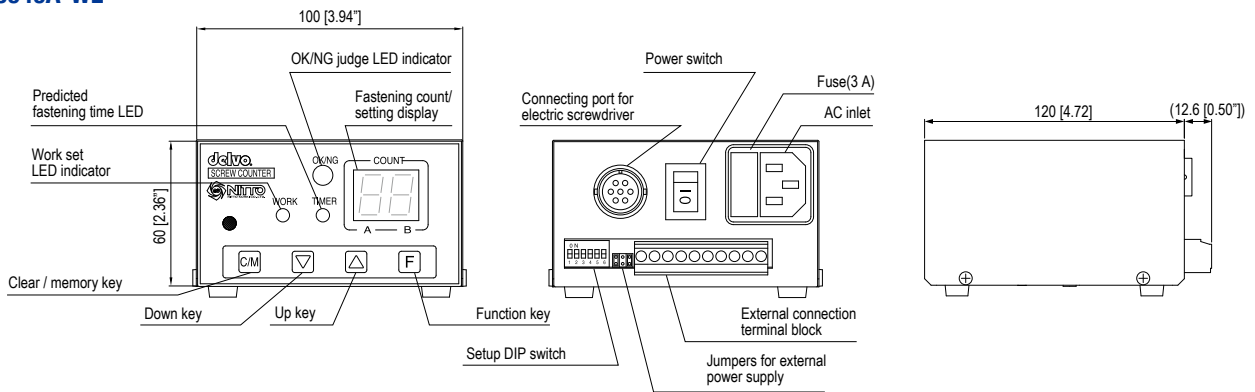

DLR5340-WE

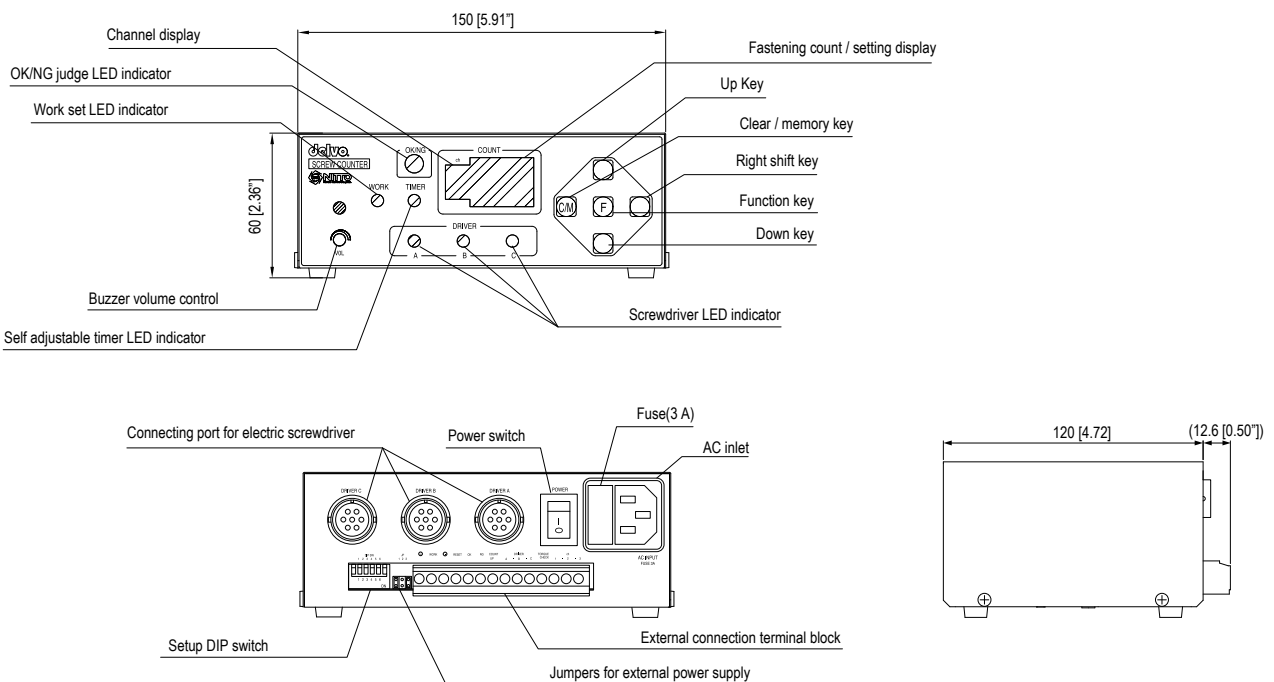

DLV30A06A-N/DLV30A12A-N/DLV30A20A-N

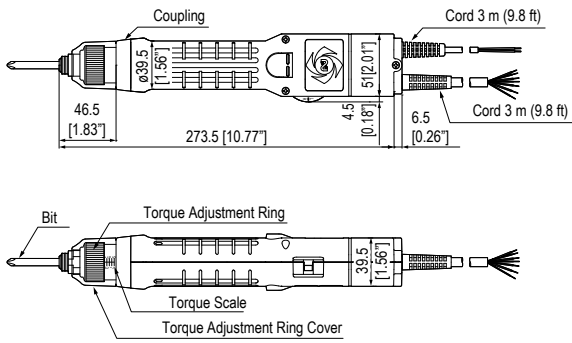

DLV45A06A-N/DLV45A12A-N/DLV70A06A-N

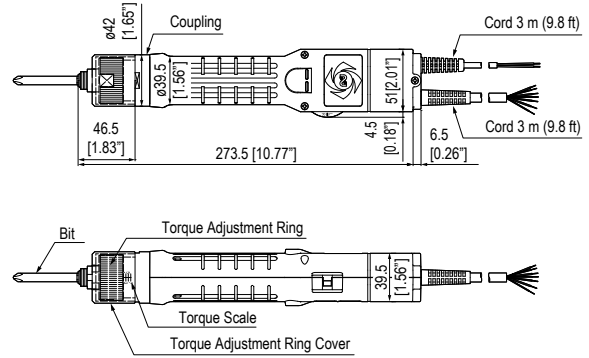

DLV30A06A-F/DLV30A12A-F/DLV30A20A-F

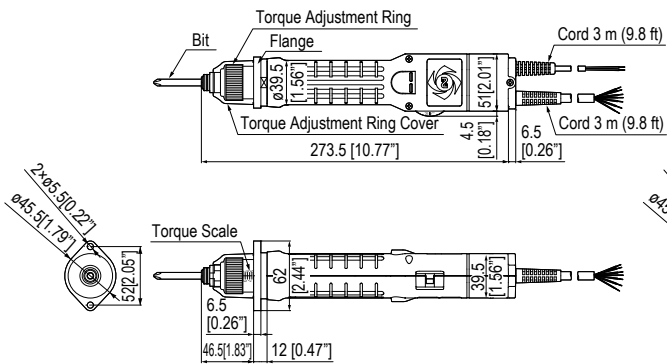

DLV45A06A-F/DLV45A12A-F/DLV70A06A-F

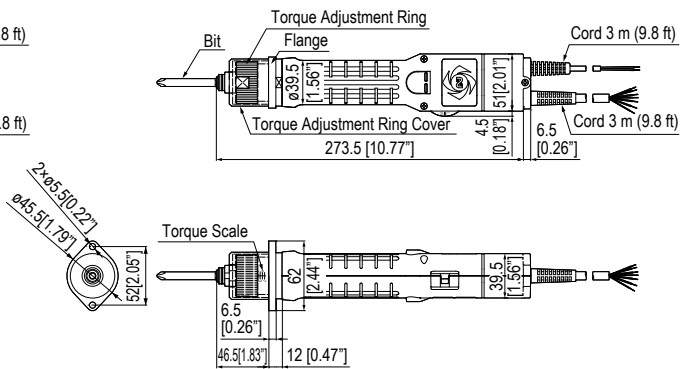

DLV30A06A-M/DLV30A12A-M/DLV30A20A-M

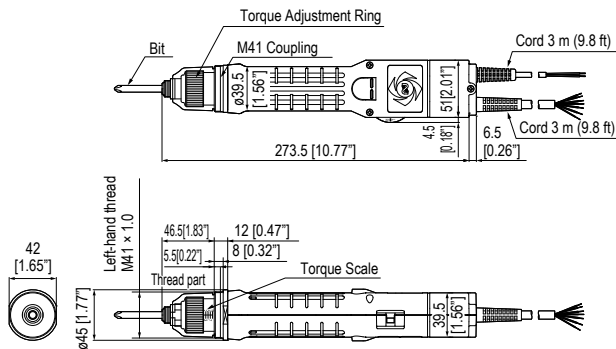

DLV45A06A-M/DLV45A12A-M/DLV70A06A-M

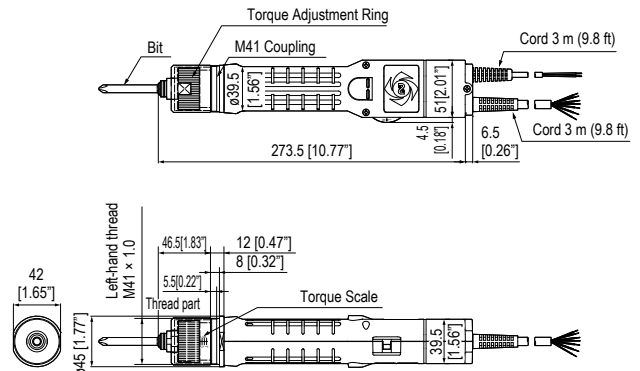

DLP7401-J

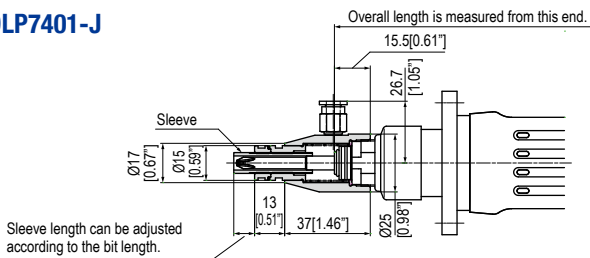

DLP7401-K

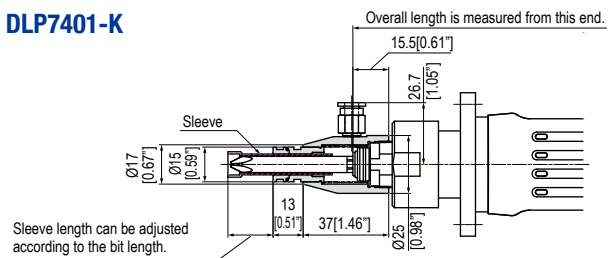

*When mounted on automated machine.

DLV3321/DLV3331

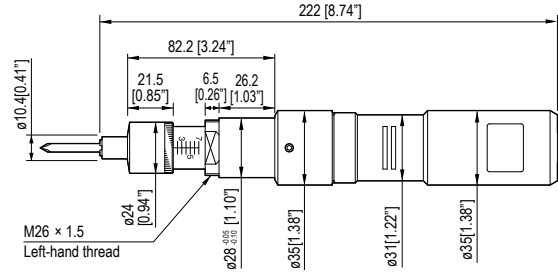

DLV3121/DLV3131/DLV3141/DLV3151

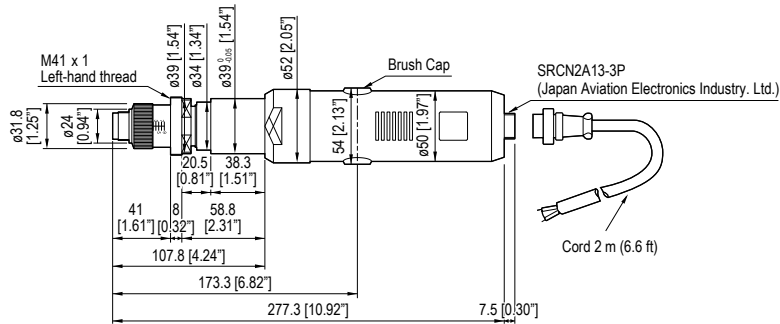

DLC3310 (Optional)

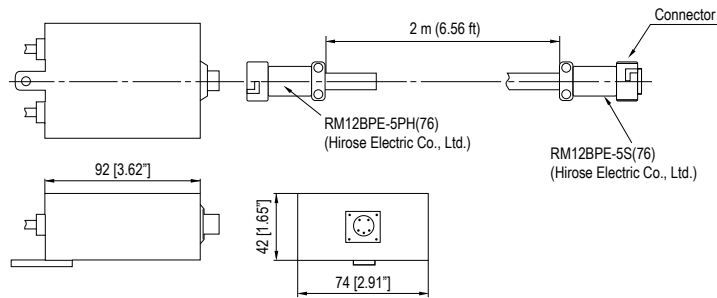

DLT1173A/DLT1673A

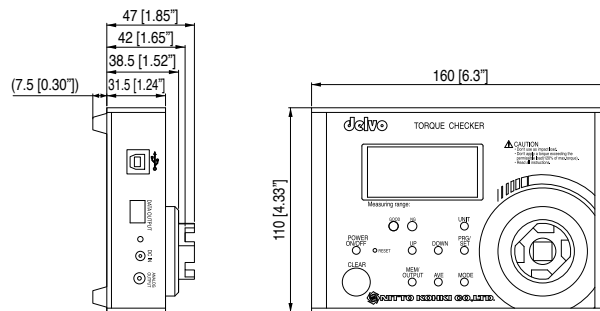

DLT1973A

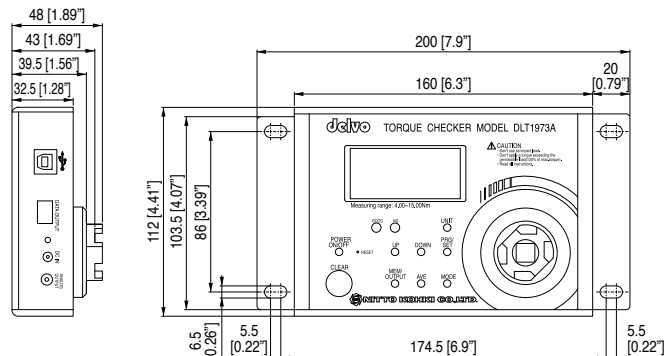

External Dimensions unit: mm [inch]

See page 50

DTM10

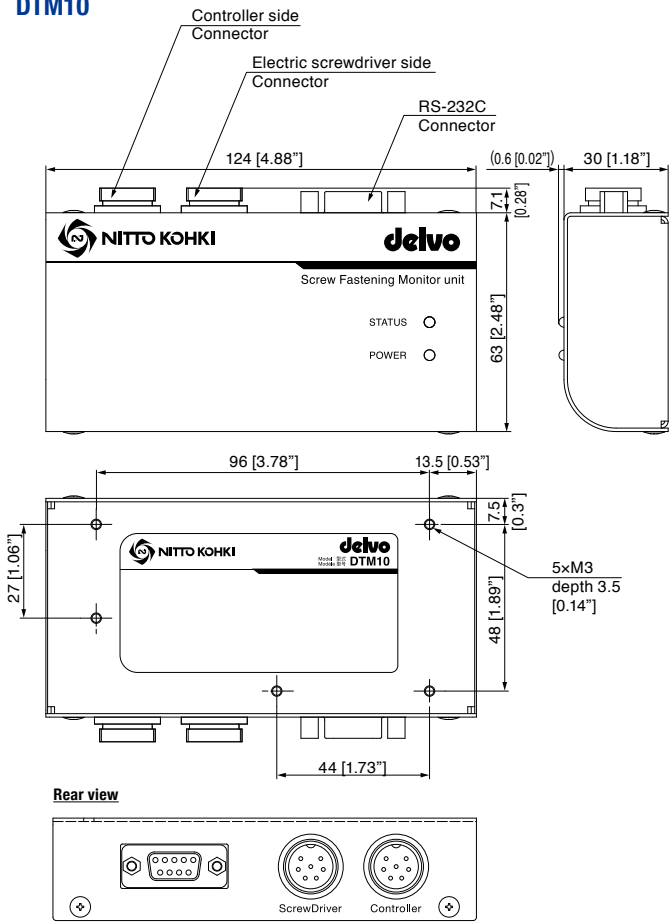

DTM45

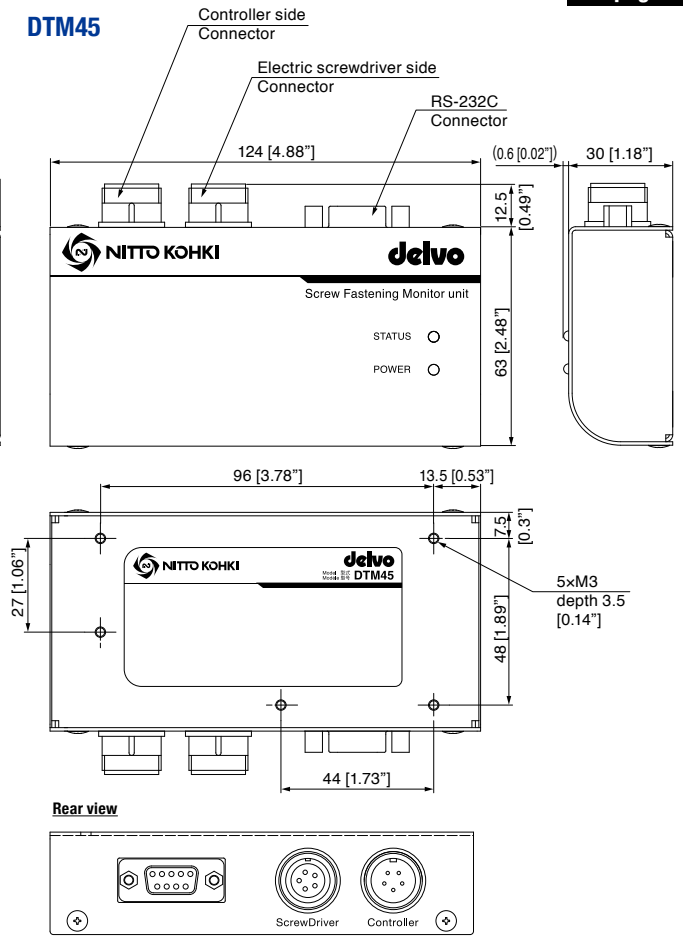

See page 50

Vertical type DRA-SW-650 (Swing type)

Vertical type DRA-SL-650 (Slide type)

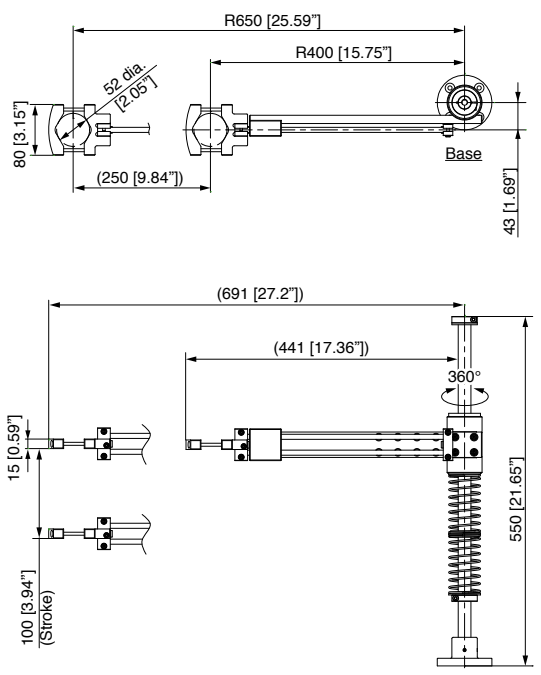
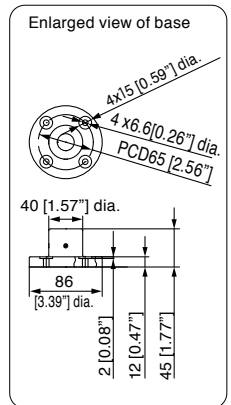
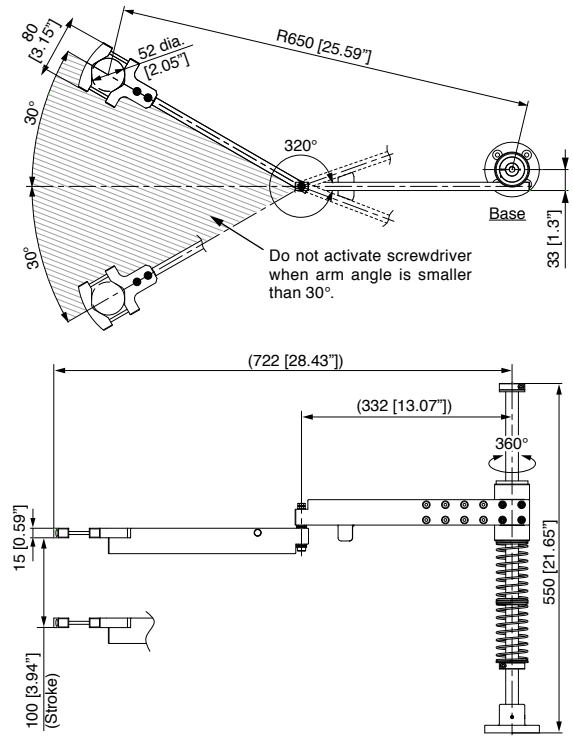

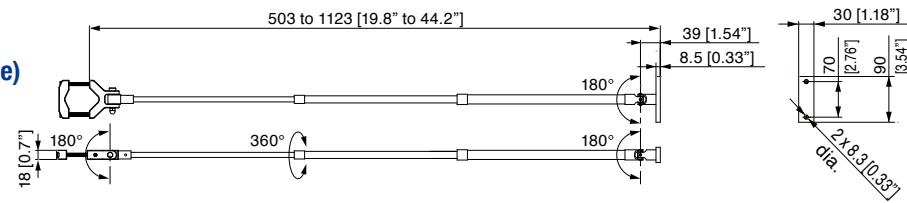

Extendable type DRA-TS-1000 (Telescope type)



SAFETY GUIDE

Be sure to read and understand the following safety notations and all safety precautions.

 **WARNING:** Indicates a potentially hazardous situation which, if failure to comply with the instructions given, could result in serious injury or death.

 **CAUTION:** Indicates a potentially hazardous situation which, if failure to comply with the instructions given, could result in injury or material damage.

Safety Precautions

- Be sure to follow the safety precautions to keep accidents such as fires, electroshock, and injuries from occurring.
- Before using your tool, please read this manual carefully so that you may use it properly to get the most out of it.
- Keep the manual handy – so you can use it whenever necessary.

WARNING

- Keep work area clean. Cluttered work areas and benches invite accidents and injuries.
- Consider proper working environments for each tool carefully. Do not expose electric tools to extreme amounts of moisture or direct contact with water or rain. Keep area well lit at all times to prevent hidden dangers and never operate the equipment near flammable liquids or in gaseous or explosive atmospheres.
- Prevent operators from electric shock. When using electric tools, prevent body contact with grounded surfaces (e.g. pipes and outer frames of radiators, microwave ovens, and refrigerators, etc.).
- Keep all electric tools and power cords away from children and all unauthorized personnel. Also all visitors should be kept away from work area.
- Properly store tools and accessories while not in use. They should be kept in a dry, locked-up location out of reach of children or unauthorized personnel.
- Do not force tool. It will do the job better and more safely at the rate for which it was intended.
- Use the right electric power tool that can complete the job within its specifications. Do not attempt to adapt improper attachments or accessories to complete a job. Do not use the tool for other than what they were designed for.
- Dress properly. Do not wear loose clothing and/or accessories. (gloves, necklace etc.) They can be caught in moving parts. Non-skid footwear is recommended in outdoor operation. Wear protecting hair covering to contain long hair.
- Always wear safety glasses during operation. Wear respiratory protection when working in an environment where dust particles are generated during operation.
- Do not abuse cord. Never carry tool by cord or yank it to disconnect from receptacle. Keep cord from heat, oil, and sharp edges.
- Use clamps or a vise to secure the work piece tightly and eliminate vibration. Never hold the work piece with your hands, keep both hands on the electric tool for increased productivity.
- Do not overreach. Keep proper footing and balance at all times.
- Maintain tools with care. For safe and efficient work, use the proper bit and check it regularly. Do not use the bit with a worn out or deformed tip. When oiling and replacing parts, follow the instructions given by the instruction manual. Inspect tool cords periodically and if damaged, have them replaced by an authorized service facility. Keep handles dry, clean, and free from oil and grease.
- Disconnect a tool or a controller when not in use, when repairing, or when changing accessories and bits, etc.
- Remove adjusting keys and wrenches. Form habit of checking to see that keys and adjusting wrenches are removed from tools before turning it on.
- Always avoid an unexpected start by having all power switches in the off position prior to attaching to a power supply. Never carry tools with your finger on the on/off switch when the power is attached. Never plug the cord into a receptacle while your finger is on the on/off switch.
- When the tool is used outdoors, use an electric extension cord or cable suitable for outdoor use.
- Stay alert. Watch what you are doing. When using electric tools, take good care of tool handling, working manner, and surrounding conditions. Use common sense. Do not operate tool when you are tired.
- Check damaged parts. Before further use of the tool, an accessory or other part that is damaged should be carefully checked to determine that it will operate properly and perform its intended functions. Check for alignment of moving parts, binding of moving parts, breakage of parts, mounting, and any other conditions that may affect its operation. When repairing or replacing parts, follow the directions of the instruction manual. The part that is damaged should be properly repaired or replaced by an authorized service facility unless otherwise indicated elsewhere in this operation manual. Have defective switches replaced by an authorized service facility. Do not use the tool if the switch cannot be turned on and off.
- Use only recommended accessories and attachments as per tool operator manual and “delvo” general catalog. Use of improper accessories and attachments may result in an accident or serious injury.
- Any repairs on the tool should be performed only by an authorized service facility. Do not modify the tool that is complying with the safety standard. If the repairman who has poor knowledge and skill repairs the tool, the tool may not give a good performance and result in an increased risk of injury to the user.
- The power source must be limited to the individual tools specifications as stated on the nameplate or instruction manual. If used at a higher or lower voltage than indicated, it may cause failure and result in an increased risk of injury to the user.
- Before work operation carefully check if there are underground installations such as conduit, water pipe, and gas pipe, etc. If a tool should touch them, it might cause electric shock, electric leak, or gas leak.
- Hold the tool body firmly so as not to be swung by it when using. If not, this may cause injury.
- Do not bring hand or face close to moving parts such as bit etc. when using. This may cause injury.
- When you have dropped the tool by mistake, carefully check the tool if there is breakage, cracks or deformation. This may cause injury.

CAUTION

- Install bits or accessories securely in accordance with the operation manual. Insufficient installation may cause injury.
- Whenever setting the torque, unplug the cable of the tools. Adjusting the torque setting during rotation may cause injury.
- When operating a tool at high places, check that there is no person under the places. Do not stumble over the cord nor drop the material or tool body. This may cause injury.
- Never leave a tool running unattended on the working bench or floor. Always turn the power switch or lever to the off position and disconnect from the power source when not in use.
- Do not overload to the extent that the motor locks or the clutch malfunctions. This may cause smoke, fire, failure or injury.
- If the tool is overheating or functioning abnormally, stop using the screwdriver immediately and inspect it to see whether any repairs are necessary. Otherwise this may cause failure or injury.
- The electric screwdriver may overheat depending on the type of screw, type of screw-tightened material, or frequency of use. To avoid overheating, stop operating the screwdriver for a time or use several drivers in alteration. Overheating may reduce the life of the product or cause failure or injury.
- The fastening torque may vary depending on how the product is operated or held, the type of screw, and the fastening conditions. Use a torque wrench or similar tool to check that the fastening torque is appropriate.

How to select a suitable model

A suitable model can be selected in 5 steps.

1

Check the torque and screw size

Case A	Case B
<ul style="list-style-type: none"> Fastening M4 screws with a fastening torque of 1.0 Nm. The material of the workpiece is stainless steel. 	<ul style="list-style-type: none"> Fastening M3 screws with a fastening torque of 0.5 Nm. The material of the workpiece is plastic.

CHECK!

Torque Adjustment		Stepless
Torque (Nm [lbf-in])	0.03 to 0.2 [0.3 to 1.8]	0.15 to 1.2 [1.3 to 10.6]
Free Speed (min ⁻¹)	700 - 1000	
Power Consumption (W)	48	
Screw Size (mm)	Machine Screw	1.0 to 2.2
	Tapping Screw	1.4 to 2.6
Mass (g [lbs])	470 (1.04)	

Check the torque and screw size in the specification chart.

*Please refer to the List of Screwdrivers on page 3 to 7.

2

Select the starting method

<ul style="list-style-type: none"> A push start model is required as the production tact is fast. 	<ul style="list-style-type: none"> A lever start model is required as the workers are not skilled.
--	---

CHECK!

Starting Method	Lever Start	Push Start
Power Source	20 to 30 V DC	20 to 30 V DC
Torque Adjustment	Stepless	Stepless

Check the starting method in the specification chart.

3

Select the free speed

<ul style="list-style-type: none"> A high speed model is required to enhance working efficiency. 	<ul style="list-style-type: none"> A low speed model is required to fasten tapping screws.
---	---

CHECK!

Torque (Nm [lbf-in])	0.15 - 1.2 [1.3 - 10.6]
Free Speed (min ⁻¹)	700 to 1000
Power Consumption (W)	48
Screw Size	Machine Screw 1.4 to 3.0







Check the free speed in the specification chart.

4

Select the voltage and features

<ul style="list-style-type: none"> A low voltage model is required for safety. Function for reducing the rotation speed at the beginning and end of fastening is required to prevent screw fastening failures. 	<ul style="list-style-type: none"> Variable speed function is preferred. Built-in screw fastening counter function is required.
--	---

CHECK!

      
--

Check the features with the pictograms.

*Please see page 2 for the detailed information of the symbols.

5

Select the model

<p>DLV30S20P-AYK and dedicated controller DEA0241N-AZ</p> 	<p>DLV10C10L-AYK and dedicated controller DCC0101X-AZ</p> 
--	--

*The above selected models are only examples.



Electric Screwdrivers

The logo for "delvo" is registered trademark or a trademark of Nitto Kohki Co., Ltd. in Japan, the United States and/or certain other countries.



Japanese
www.nitto-kohki.co.jp/network/jp/



Vietnamese
www.nitto-kohki.co.jp/network/vi/



English
www.nitto-kohki.co.jp/network/



Indonesian
www.nitto-kohki.co.jp/network/id/



Thai
www.nitto-kohki.co.jp/network/th/



Spanish
www.nitto-kohki.co.jp/network/es/



YouTube
NITTO KOHKI GLOBAL



eCatalog
www.nitto-kohki.co.jp/e/prd/d_cat/

NITTO KOHKI CO., LTD.

Head Office

2-9-4, Nakaikegami, Ota-ku, Tokyo 146-8555, Japan

Tel : +81-3-3755-1111 Fax : +81-3-3753-8791 E-mail : overseas@nitto-kohki.co.jp

Web www.nitto-kohki.co.jp/e/



ISO9001
JQA-2025
ISO14001
JQA-EM4057
H.Q./R&D Lab

Overseas Affiliates / Offices

NITTO KOHKI U.S.A., INC.

46 Chancellor Drive, Roselle, Illinois 60172, U.S.A.

For Tool

Tel : +1-630-924-9393 Fax : +1-630-924-0303

For CUPLA

Tel : +1-630-924-5959 Fax : +1-630-924-1174

For Pump

Tel : +1-630-924-8811 Fax : +1-630-924-0808

www.nittokohki.com/

NITTO KOHKI EUROPE GMBH

Gottlieb-Daimler-Str. 10, 71144 Steinenbronn, Germany

Tel : +49-7157-989555-0 Fax : +49-7157-989555-40

www.nitto-kohki.eu/

NITTO KOHKI EUROPE GMBH UK Branch

Unit A5, Langham Park Industrial Estate, Maple Road,

Castle Donington, Derbyshire DE74 2UT, United Kingdom

Tel : +44-1332-653800 Fax : +44-1332-987273

www.nitto-kohki.eu/

NITTO KOHKI CO., LTD. Bangkok Representative Office

2 Jasmine Building, 22nd Floor, Soi Prasarnmit(Sukhumvit23),

Sukhumvit Road, North Klongtoey, Wattana, Bangkok 10110, Thailand

Tel : +66-2612-7388

Thai www.nitto-kohki.co.jp/network/th/

Vietnamese www.nitto-kohki.co.jp/network/vi/

NITTO KOHKI CO., LTD. India Liaison Office

14th Floor, Tower 5B, DLF Eptome, DLF Cyber City, Phase 3, Gurugram,

Haryana 122002, India

Tel : +91-124-460-7701

www.nitto-kohki.co.jp/network/

NITTO KOHKI CO., LTD. Singapore Branch

18, Kaki Bukit Road 3, #02-12, Entrepreneur Business Centre, Singapore 415978

Tel : +65-6227-5360 Fax : +65-6227-0192

www.nitto-kohki.co.jp/network/

NITTO KOHKI CO., LTD. Indonesia Representative Office

Plaza Marein 23rd Floor Jl. Jend. Sudirman Kav. 76-78, Jakarta 12910, Indonesia

Tel : +62-21-8065-7808

www.nitto-kohki.co.jp/network/id/

NITTO KOHKI AUSTRALIA PTY LTD

77 Brandl Street, Eight Mile Plains, Queensland 4113, Australia

Tel : +61-7-3340-4600 Fax : +61-73340-4640

www.nitto-australia.com.au/

NITTO KOHKI (SHANGHAI) CO., LTD.

Room 2602, Shanghai International Trade Centre,

No.2201 Yan An West Road, Shanghai 200336, China

Tel : +86-21-6415-3935 Fax : +86-21-6472-6957

www.nitto-kohki.cn/

NITTO KOHKI (SHANGHAI) CO., LTD. Shenzhen Branch

Room 708, Building 1, Wanting Building, No. 2009 Baoyuan Road,

Baoan District, Shenzhen, Guangdong 518102, China

Tel : +86-755-8375-2185 Fax : +86-755-8375-2187

www.nitto-kohki.cn//

DISTRIBUTED BY



บริษัท นานดีอินเตอร์เทรด จำกัด
NANDEE INTER-TRADE CO., LTD.

314, 316, 318, 320, 322 ซอยจันทน์ 32 ถนนจันทน์ แขวงทุ่งวัดดอน เขตสาทร กทม. 10120

Tel : 0-2675-8239

E-mail : info@nandee.co.th

<http://www.nandee.co.th>



This catalog is printed using environmentally friendly paper and vegetable oil inks.