

# TONE®

TONE® Made in Japan





## HAND TOOLS เครื่องมือช่าง

Tool Set – Tool Case ชุดอุปกรณ์ - กล่องอุปกรณ์ .....	G3
Hexagon Wrench ประแจ 6 เหลี่ยม .....	G9
Spanner Offset Wrench ประแจปากตาย ประแจแวน ประแจแวนหัวปากตาย .....	G10
Socket Wrench ชุดลูกบล็อกซ์ .....	G13
Torque Wrench ประแจปอนด์ .....	G14
Torque Grip ประแจทอร์ค.....	G16
Screwdriver ไขควง .....	G19
Other Tool ค้อน .....	G20



# TOOL SET ( STANLESS STEEL )

## ชุดกล่องพร้อมเครื่องมือ 44 ชิ้น



SU352

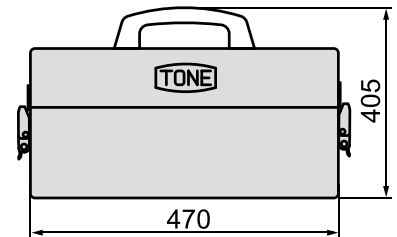
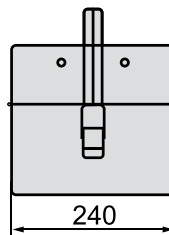

Weight : 10.9 kg  
(9.5 mm / 3/8")

44  
pieces set

9.5  
mm  
3/8"

Product list		Detail
ลูกบ็อกซ์ 3/8"	Socket (6pt.)	S3V-8, 10, 12, 13, 14, 17, 19, 21, 22, 24
ด้ามพรี	Ratchet Handle	SRH3H
ข้อต่อ 3/8"	Extension Bar	SEX30-075 (75mm), 150 (150mm)
ประแจแอลหัวบอล	Ball point Hex. Key Wrench	SBL-2.5, 03, 04, 05, 06, 08 10
ประแจแวนข้างปากตาย	Combination Wrench	SMS-08, 10, 12, 13, 14, 17, 19, 21, 22, 24
คีมปากจิ้งจก	Linemen's Pliers	SCT-175
คีมปากแหลม	Needle Nose Pliers	SRP-150
คีมตัดปากเฉียง	Diagonal Cutting Pliers	SKN-150
คีมปากขยาย	Combination Pliers	SCP-150N
ไขควง - ปากแบน	Screwdriver	SMD-075, 100, 150
ไขควง - ปากแฉก	Screwdriver	SPD-001, 002, 003
ไขควงตัวสั้น	Stubby Screwdriver	SSSD-M2, P2
ค้อน	Hammer	SH-10
กล่องเครื่องมือ	Tool Case	SBX120



# TOOL SET ( SERVICE KIT WITH SHUTTER )

## แผงแขวนพร้อมเครื่องมือ 74 ชิ้น ( พร้อมบานสไลด์ปิด )

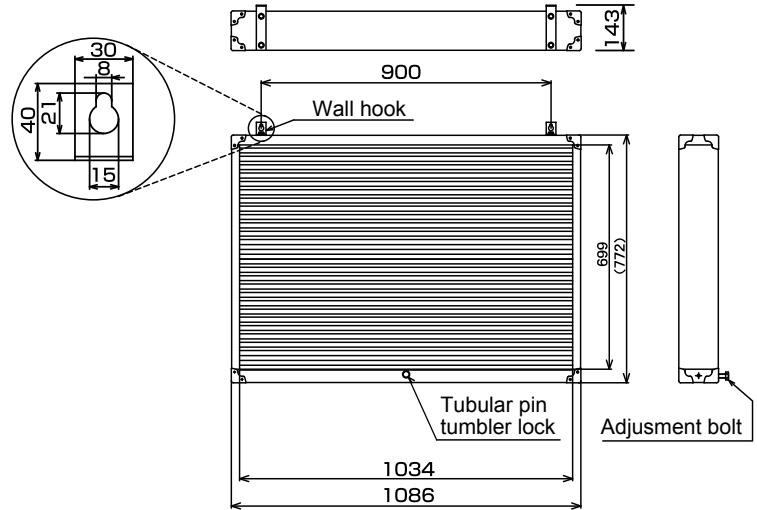
**C635**

Weight : 26.3 kg

(6.35 mm / 1/4"), (12.7 mm" / 1/2")

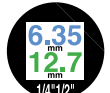

Made in Japan

 TOOL SET  
TOOL CASE

Product list		Detail
ลูกบ็อกซ์ 1/4"	Socket (6pt.)	2S-5, 5.5, 7, 8, 10, 12
ลูกบ็อกซ์ 1/2"	Socket (6pt.)	4S-10, 12
	Socket (12pt.)	4D-13, 14, 17, 19, 21, 22, 24, 27, 30, 32
ด้ามพรี่ 1/2"	Ratchet Handle	RH4H
ด้ามเลื่อน	T-Type Driver Handle	SL20
บ็อกซ์ด้ามไขควง	Driver Handle	115
ข้อต่อ 1/2"	Extension Bar	321 (150 mm)
ข้ออ่อน 1/2"	Ball Joint	BJ40
ประแจปากตาย	Spanner	DS-5.5x7, 8x10, 10x12, 11x13, 12x14, 14x17, 19x21, 22x24
ประแจแหวน, ยาว	Long Offset Wrench (45°)	M45- 10x12, 11x13, 12x14, 14x17, 19x21, 22x24
ประแจแหวนข้างปากตาย	Combination Wrench	CS- 10, 12, 13, 14, 17, 19, 21
ไขควง (ด้ามยาง)	Power Grip Screwdriver	PGMD-75, -100, -150, PGPD- + No.1, No.2, No.3
ประแจเลื่อน 200, 300 mm	Adjustable Wrench	MW-200, MW-300
คีมปากขยาย 200 mm	Combination Slim Pliers	CPS-200G
คีมค้อน	Water Pump Pliers	SWP-250
คีมหนีบแหวน	Snap Ring Pliers	SRPH-175, SRPS-175
คีมปากจิ้งจก 175 mm	Lineman's Pliers	CT-175G
คีมปากแหลม 150 mm	Needle Nose Pliers	RP-150G
คีมปากเฉียง 150 mm	Diagonal Cutting Pliers	KN-150G
คีมจับท่อ	Pipe Wrench	PW300 mm
คีมล็อก 250 mm	Grip Pliers	VP-250
คีมตัด	Mini Cutter	MCH-200
ค้อน 1 ปอนด์	Combination Hammer	BHC-10 (1 pound)
ค้อนยาง	Shockless Hammer	UH-10 (1 pound)
ประแจแอลหัวบอลยาว	Long Ball Point Hex Key Wrench set	BL900 (1.5, 2, 2.5, 3, 4, 5, 6, 8, 10)
แผงแขวนเครื่องมือพร้อมบานปิด	Service Board with Shutter	C635B

# TOOL CABINET SET

## ชุดตู้รถเข็นพร้อมเครื่องมือ 87 ชิ้น



TCX911

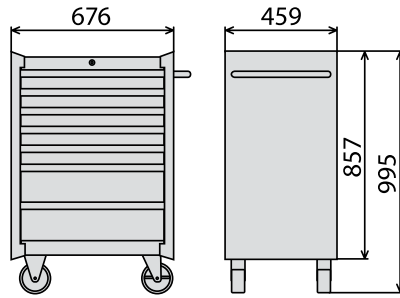

Weight : 76.8 kg

(9.5, 12.7 mm / 9.5", 1.2")

Cabinet Color : Red / Silver / Matted Black



Made in Japan

 TOOL SET  
TOOL CASE

Product list	Detail
ลูกบ็อกซ์ 3/8"	Socket (6pt.) 3S-08, 10, 11, 12, 13, 14
ลูกบ็อกซ์ยาว 3/8"	Deep Socket (6pt.) 3S-08L, 10L, 12L, 13L, 14L
ลูกบ็อกซ์ 1/2"	Socket (12pt.) 4D-17, 19, 21, 22, 24, 26, 27, 30, 32, 36
ลูกบ็อกซ์เดียวโพล์ 1/2"	Hexagon Socket 4H-05, 06, 08, 10, 12, 14, 17
ด้ามพรี 3/8"	Ratchet Handle (Socket Hold Type) RH3H
ด้ามพรี 1/2"	Ratchet Handle (Socket Hold Type) RH4H
ด้ามบ็อกซ์	Spinner Handle NS4
ด้ามขันตัวที่ 3/8"	T-Type Handle TH3270
ข้อต่อ 3/8"	Extension Bar 305(75mm), 306(150mm)
ข้อต่อ 1/2"	Extension Bar 320(75mm), 321(150mm), 407(250mm)
ข้ออ่อน 3/8"	Ball Joint BJ30
ข้ออ่อน 1/2"	Ball Joint BJ40
ข้อเพิ่ม (3/8" x 1/2")	Socket Adaptor 58
ข้อลด (1/2" x 3/8")	Socket Adaptor 68
ประแจปากตาย	Spanner DS-5.5x7, 8x10, 10x12, 11x13, 12x14, 14x17
ประแจแหวนคอยาว (45°)	Long Offset Wrench M45-10x12, 11x13, 12x14, 14x17, 19x21, 22x24
ประแจแหวนตัวสั้น (45°)	Short Offset Wrench M46-8x10, 10x12, 11x13, 14x17
ประแจเลื่อน	Adjustable Wrench MW-300
ประแจเลื่อนด้ามสั้น	Short Adjustable Wrench MWS-24
คีมปากขยาย	Combination Pliers CP-200SG
คีมปากจิ้งจก	Linemen's Pliers CT-175G
คีมปากแหลม	Needle Nose Pliers RT-150G
คีมปากเฉียง	Diagonal Cutting Pliers KN-150G
คีมตัด	Mini Cutter MCH-200
คีมคอบ่า	Water Pump Pliers SWP-250
คีมถอนหมุด	Broken Nut Pliers BNP-175
ไขควง (ด้ามยาง)	Power Grip Screwdriver (-) PGMD-075, 100, 150
ไขควง (ด้ามยาง)	Power Grip Screwdriver (+) PGPD-001, 002, 003
ไขควงสำหรับงานหนัก	Heavy Duty Screwdriver YMD-150
ค้อน 1 ปอนด์	Combination Hammer BHC-10 (1 pound)
คีมจับท่อ	Aluminium Pipe Wrench APW-300 (300mm)
เหล็กสกัด	Chisel FC-165 (19x165 mm)
ประแจแอลหัวบอลยาว	Long Ball Point Hex Key Wrench Set BL900 (BL-1.5, 2, 2.5, 3, 4, 5, 6, 8, 10)
รางใส่ลูกบ็อกซ์	Socket Holder SH1407
ตู้เครื่องมือแบบลิ้นชัก 7 ชั้น	Roller Cabinet WS207R or WS207S of WS207B

# TOOL CABIN SET

## รถเข็นพร้อมเครื่องมือ 56 ชิ้น

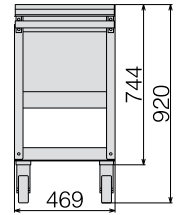
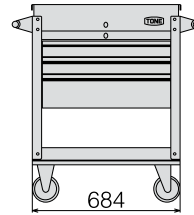
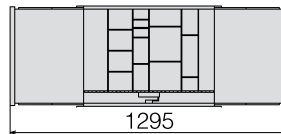
**TCA470**

 Weight : 49.4 kg  
(12.7 mm./ 1/2")

Product list		Detail
ลูกบ็อกซ์ 1/2"	Socket (6pt.)	4S-08, 10, 12, 13, 14, 17, 19, 21, 22, 24
ลูกบ็อกซ์ถอดหัวเทียน 1/2"	Plug Socket (6pt. with magnet)	4P-16, 20.8
ด้ามพรี 1/2"	Ratchet Handle (with Socket Hold Type)	RH4H
ข้อต่อ 1/2"	Extension Bar	320 (75 mm), 321 (150 mm)
ประแจปากตาย	Spanner	DS-5.5x7, 8x10, 10x12, 11x13, 12x14, 14x17
ประแจแหวน, ยาว	Mechanic Offset Wrench, Long Type	M44-8x10, 10x12, 12x14, 14x17, 19x21, 22x24
ประแจแหวน, สั้น	Short Offset Wrench	M46-10x12
ประแจแหวนผ่า	Flare Nut Wrench	M26-10x12
ประแจเลื่อน 300 mm	Adjustable Wrench	MW-300
คีมปากขยาย	Combainiton Slim Pliers	CPS-200G
คีมปากแหลม 150 mm	Needle Nose Pliers	RP-150G
คีมปากเฉียง 150 mm	Diagonal Cutting Pliers	KN-150G
ไขควง (ด้ามยาง)	Power Grip Screwdriver (-)	PGMD-075, 100
ไขควง (ด้ามยาง)	Power Grip Screwdriver (+)	PGPD-001, 002, 003
ไขควง (ด้ามยาง) ตัวสั้น	Power Grip Stubby Screwdriver (-)	PGSD-M2
ไขควง (ด้ามยาง) ตัวสั้น	Power Grip Stubby Screwdriver (+)	PGSD-P2
ไขควง (งานหนัก)	Heavy Duty Screwdriver (-)	YMD-150
ค้อน 1 ปอนด์	Ball Peen Hammer	BH-10 (1 pound)
ตัวถอดผ้าเบรค	Brake Shoe Adjusting Tool	BST-110
เหล็กสกัด	Chisel	FC165 (19x165 mm)
เหล็กตอก	Punch	CP125 (125 mm)
เหล็กขูด	Scraper	SSC-22
ประแจแอลหัวบอลยาว	Long Ball Point Hex Key Wrench Set	BL900 (BL-1.5, 02, 2.5, 03, 04, 05, 06, 08, 10)
ตู้เครื่องมือ	Tool Case	TC7001R or TC1701R

# TOOL SET

## รถเข็นพร้อมเครื่องมือ 62 ชิ้น

Included  
**GEKKOU**  
drill bits



TSS450

Weight : 21.1 kg  
(12.7 mm / 1/2")

Chest Color : Red / Silver / Matted Black



Product list	Detail	
ลูกบ็อกซ์ 1/2"	Socket (12pt.)	4D-10, 12, 13, 14, 17, 19, 21, 22, 24, 26, 27, 30, 32
ด้ามพรี 1/2"	Ratchet Handle (Socket Hold Type)	RH4H
ด้ามบ็อกซ์	Spinner Handle	NS4
ข้อต่อ 1/2"	Extension Bar	320(75 mm), 321(150 mm)
ข้ออ่อน 1/2"	Universal Joint	UJ40
ประแจแหวงคอยาว (45°)	Offset Wrench, Long Type	M45-10X12, 11X13, 14X17, 19X21, 22X24, 24X27
ประแจแหวงพรีข้างปากตาย	Gear Wrench, Standard	RM-08, 10, 12, 13, 14, 17, 19, 21, 22, 24
ประแจเลื่อน	Adjustable Wrench	MW-300
ประแจเลื่อนด้ามสั้น	Adjustable Wrench Short Type	MWS-24
คีมปากขยาย	Combination Pliers	CP-200SG
คีมคอบ่า	Lineman's Pliers	CT-175G
คีมปากแหลม	Needle Nose Pliers	RP-150G
คีมปากเฉียง	Diagonal Cutting Pliers	KN-150G
คีมตัด	Mini Cutter	MCH-200
คีมคอบ่า	Water Pump Pliers	SWP-250
คีมถอนหมุด	Broken Nut Pliers	BNP-175
ไขควง (ด้ามยาง)	Power Grip Screwdriver (-)	PGMD-075, 100, 150
ไขควง (ด้ามยาง)	Power Grip Screwdriver (+)	PGPD-001, 002, 003
ไขควงสำหรับงานหนัก	Heavy Duty Screwdriver	YMD-150
ค้อน 1 ปอนด์	Combination Hammer	BHC-10 (1 pound)
เหล็กสกัด	Chisel	FC165 (19X165MM)
ประแจแอลหัวบอลยาว	Ball Point Hex Key Wrench Set	BL900 (BL-1.5, 2, 2.5, 3, 4, 5, 6, 8, 10)
ดอกสว่าน	HSS-CO Drill Bit	2.0, 2.5, 3.0, 3.5, 4.0, 4.5, 5.0, 5.5, 6.0 MM (OPTIONAL)
ดอกสว่าน 19 ดอก	HSS-CO Drill Bit Set	NGK3-10T (OPTIONAL)
กล่องเครื่องมือ	Tool Chest	BX230 (TSS450)



# TOOL SET

## ชุดกล่องพร้อมเครื่องมือ 53 ชิ้น

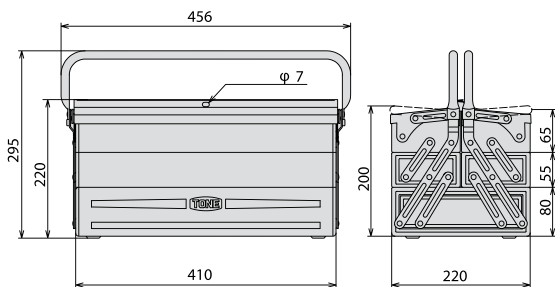
**700SD**

 Weight : 13.4 kg  
(12.7 mm / 1/2")

**53**  
pieces set

**12.7**  
mm  
1/2"

Product list		Detail
ลูกบ็อกซ์ 1/2"	Socket (6pt.)	4S-8, 10, 12, 13, 14
ลูกบ็อกซ์ 1/2"	Socket (12pt.)	4D-17, 19, 21, 22, 24, 26, 27, 30, 32
ด้ามพรี 1/2"	Ratchet Handle (Socket Hold Type)	RH4H
ด้ามบ็อกซ์	Short Spinner Handle	NS4S
ข้อต่อ 1/2"	Extension Bar 1/2"	321 (150 mm)
ประแจปากตาย	Spanner Set	DS602P (DS-5.5x7, 8x10, 11x13, 12x14, 17x19, 22x24)
ประแจแหวนควยาว (45°)	Long Offset Wrench	M45-10x12, 11x13 14x17, 19x21, 22x24
ประแจเลื่อน 300 mm	Adjustable Wrench	MW-300
คีมปากแหลม	Needle Nose Pliers	RP-150G
คีมปากขยาย	Combination Pliers	CP-200SG
คีมปากจิ้งจก 175 mm	Lineman's Pliers	CT-175G
คีมค้อนน้ำ	Water Pump Plier	KWP-250
คีมตัดปากเฉียง	Diagonal Cutting Pliers	KN-150G
ไขควง (ด้ามยาง)	Screwdriver (Through Type) (-)	KMD-075, 100, 150
	Screwdriver (Through Type) (+)	KPD-001, 002, 003
ค้อน 1 ปอนด์	Combination Hammer	BHC-10 (1 pound)
เหล็กสกัด	Chisel	FC165 (19x165 mm)
เหล็กตอก	Punch	CP125 (125 mm)
ประแจแอลหัวบอลยาว	Long Ball Point Hex Key Wrench Set	BL900 (BL-1.5, 2, 2.5, 3, 4, 5, 6, 8, 10)
ดอกสว่าน	HSS-CO Drill Bit	2, 2.5, 3, 3.5, 4, 4.5, 5, 5.5, 6 mm (optional)
กล่องเครื่องมือ	Tool Case	BX430



# BALL POINT HEX KEY WRENCH (L-TYPE)

## ประแจหกเหลี่ยมหัวบอล



Made in Japan

 HEXAGON  
WRENCH

**BS-04**

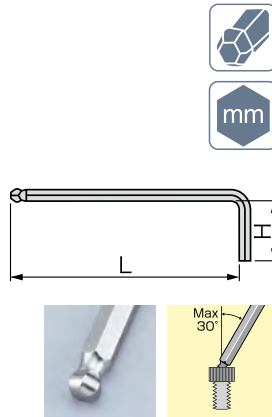
**BS-08**

Item No.	Across Flat (mm)	H (mm)	L (mm)
BS-1.5	1.5	14	51
BS-02	2	16	58
BS-2.5	2.5	18	65
BS-03	3	20	74
BS-04	4	25	78
BS-05	5	28	89
BS-06	6	32	101
BS-08	8	36	112
BS-10	10	40	128

Item No.	Content : (mm)	Qty
BS900	1.5 2 2.5 3 4 5 6 8 10	9

# LONG BALL POINT HEX KEY WRENCH

## (L-TYPE)

## ประแจหกเหลี่ยมหัวบอลยาว

**BL-08**

**BL-04**

**BL700**
**BL900**

Item No.	Across Flat (mm)	H (mm)	L (mm)
BL-1.5	1.5	14	81
BL-02	2	16	96
BL-2.5	2.5	18	111
BL-03	3	20	127
BL-04	4	25	142
BL-05	5	28	160
BL-06	6	32	180
BL-08	8	36	198
BL-10	10	40	225

Item No.	Content : (mm)	Qty
BL700	1.5 2 2.5 3 4 5 6	7
BL900	1.5 2 2.5 3 4 5 6 8 10	9

# SPANNER OFFSET WRENCH

ประเภทสาย



DS

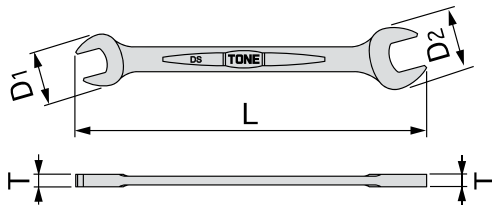

DS600P



DS602P



DS601P



DS700P

Item No.	Size	D1 (mm)	D2 (mm)	T (mm)	L (mm)
DS-5.507	5.5x7	12.0	15.0	3.2	104
DS-0607	6x7	12.0	15.0	3.2	104
DS-0708	7x8	15.0	17.0	4.0	111
DS-0809	8x9	17.0	19.0	4.5	119
DS-0810	8x10	17.0	21.0	4.5	126
DS-1012	10x12	21.0	25.0	5.0	141
DS-1013	10x13	21.0	27.0	5.0	149
DS-1113	11x13	23.0	27.0	5.5	149
DS-1214	12x14	25.0	28.5	6.0	156
DS-1317	13x17	27.0	35.0	6.5	179
DS-1417	14x17	28.5	35.0	7.0	179
DS-1618	16x18	33.0	37.0	7.5	186
DS-1719	17x19	35.0	39.0	7.5	194
DS-1921	19x21	39.0	43.0	8.0	209
DS-1922	19x22	39.0	45.0	8.0	216
DS-2123	21x23	43.0	47.0	8.0	224
DS-2224	22x24	45.0	49.0	8.5	231
DS-2326	23x26	47.0	52.0	9.0	246
DS-2427	24x27	49.0	55.5	9.5	254
DS-2730	27x30	55.5	60.0	10.0	276

TONE  
Made in Japan

SPANNER OFFSET  
WRENCH

Item No.	Contents
DS600P	DS-5.5X07, 08X09, 10X12, 11X13, 12X14, 14X17
DS601P	DS-08X09, 10X12, 12X14, 14X17, 19X21, 23X26
DS602P	DS-5.5X07, 08X10, 11X13, 12X14, 17X19, 22X24
DS700P	DS-5.5X07, 08X10, 10X12, 11X13, 12X14, 14X17, 17X19
DS700	DS-5.5X07, 08X10, 10X12, 11X13, 12X14, 17X19, 22X24, 27X30

# COMBINATION WRENCH

## ประแจควงข้างปากตาย



CS



CS-12



CS-14



CS-17



CS-19

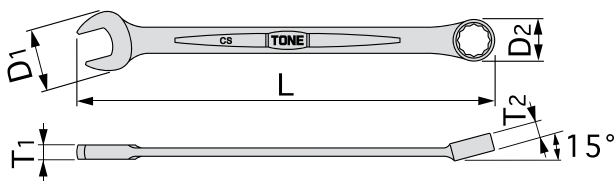

CS700P

Item No.	Size	D1 (mm)	D2 (mm)	T2(mm)	L(mm)
CS-5.5	5.5X5.5	12.0	9.0	5.0	88
CS-06	6X6	12.0	9.0	5.0	101
CS-07	7X7	15.0	11.0	5.5	113
CS-08	8X8	17.0	12.0	6.0	126
CS-09	9X9	19.0	13.5	6.5	138
CS-10	10X10	21.0	14.5	6.5	151
CS-11	11X11	23.0	16.5	7.0	164
CS-12	12X12	25.0	17.5	7.5	176
CS-13	13X13	27.0	18.5	8.0	189
CS-14	14X14	28.5	20.0	8.5	201
CS-15	15X15	31.0	21.5	9.0	214
CS-16	16X16	33.0	23.0	9.5	227
CS-17	17X17	35.0	24.5	9.5	239
CS-18	18X18	37.0	26.0	10.5	252
CS-19	19X19	39.0	27.0	10.5	264
CS-20	20X20	41.0	28.5	11.5	277
CS-21	21X21	43.0	30.0	11.5	290
CS-22	22X22	45.0	31.5	12.0	302
CS-23	23X23	47.0	33.0	13.0	315
CS-24	24X24	49.0	34.0	13.5	327
CS-25	25X25	52.0	36.0	14.0	340
CS-26	26X26	52.0	36.5	14.0	353
CS-27	27X27	55.5	37.5	15.0	365
CS-28	28X28	57.5	40.5	17.0	378
CS-29	29X29	60.0	42.0	18.5	390
CS-30	30X30	60.0	42.0	18.5	403
CS-32	32X32	65.0	46.0	18.5	428
CS-33	33X33	67.5	47.5	19.0	441
CS-34	34X34	69.5	50.0	19.0	453
CS-35	35X35	72.0	52.0	20.0	466
CS-36	36X36	73.0	52.0	20.0	479
CS-38	38X38	77.0	55.0	22.0	504
CS-41	41X41	84.0	59.0	22.0	542
CS-46	46X46	94.0	66.0	24.0	605
CS-50	50X50	98.0	69.5	26.0	655



Item No.	Contents
CS700P	08 10 12 13 14 17 19

# OFFSET WRENCH LONG TYPE (45°)

## ประเภทค้อนยาว



M45



M45-1012



M45-1014



M45-2224



M45-2730

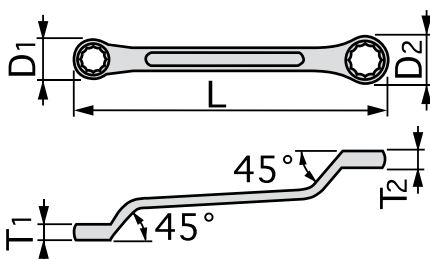

2800M

Item No.	size	D1 (mm)	D2 (mm)	T1 (mm)	T2 (mm)	L (mm)
M45-5.507	5.5X7	10.0	11.5	5.0	5.5	151
M45-0809	8X9	13.0	14.5	6.0	6.5	182
M45-0810	8X10	13.0	15.5	6.0	6.5	184
M45-1012	10X12	15.5	18.0	6.5	7.5	194
M45-1013	10X13	15.5	19.0	6.5	8.0	196
M45-1113	11X13	16.5	19.0	7.0	8.0	198
M45-1214	12X14	18.0	21.0	7.5	8.5	220
M45-1317	13X17	19.0	25.5	8.0	9.5	247
M45-1415	14X15	21.0	23.0	8.5	9.5	247
M45-1417	14X17	21.0	25.5	8.5	9.5	248
M45-1618	16X18	24.5	27.0	9.5	10.5	270
M45-1719	17X19	25.5	28.0	9.5	10.5	280
M45-1721	17X21	25.5	30.0	9.5	11.5	298
M45-1921	19X21	28.0	30.0	10.5	11.5	307
M45-1922	19X22	28.0	32.0	10.5	12.0	307
M45-1924	19X24	28.0	35.0	10.5	13.5	324
M45-2123	21X23	30.0	33.0	11.5	13.0	320
M45-2126	21X26	30.0	36.5	11.5	14.0	340
M45-2224	22X24	32.0	35.0	12.0	13.5	324
M45-2326	23X26	33.0	36.5	13.0	14.0	348
M45-2427	24X27	35.0	37.5	13.5	15.0	350
M45-2430	24X30	35.0	43.0	13.5	18.5	389
M45-2629	26X29	36.5	42.0	14.0	18.5	384
M45-2632	26X32	37.5	47.0	14.0	19.0	398
M45-2730	27X30	37.5	43.0	16.5	18.5	391
M45-2732	27X32	39.0	47.0	16.5	19.0	413
M45-2932	29X32	42.0	47.0	18.5	19.0	415
M45-3032	30X32	43.0	47.0	18.5	19.0	420
M45-3235	32X35	47.0	52.0	19.0	20.0	430
M45-3236	32X36	47.0	53.0	19.0	20.0	430
M45-3541	35X41	52.0	60.0	20.0	22.0	456

**TONE**<sup>®</sup> Made in Japan

WRENCH SET



Item No.	Contents
2800M	8X9, 10X12, 11X13, 14X17, 19X21, 22X24, 23X26, 24X27



# SOCKET WRENCH SET

## ชุดลูกบ็อกซ์พร้อมด้ามขันพรี

**160M**

Product List		Detail
ลูกบ็อกซ์ 1/2"	Socket Wrench	4D-8 9 10 11 12 13 14 17 19 21 22 23 24 26 27 29 30 32 (12pt.)
ด้ามพรี 1/2"	Ratchet Handle	RH4H
ด้ามบ็อกซ์	Spinner Handle	NS4
ด้ามเลื่อนตัวที	T-Type Slide Handle	SL40
ข้อต่อ	Extension Bar	320 321 407
ข้ออ่อน	Universal Joint	UJ40
กล่องโลหะ	Metal Case	MCT3

**760M**

Product List		Detail
ลูกบ็อกซ์ 1/2"	Socket Wrench	4D-10 11 12 13 14 17 19 21 22 24 26 27 30 32 (12pt.)
ด้ามพรี 1/2"	Ratchet Handle	RH4H
ด้ามบ็อกซ์	Short Spinner Handle	NS4S
ข้อต่อ	Extension Bar	321
ข้ออ่อน	Ball Joint	BJ40
กล่องโลหะ	Metal Case	MCT2

**760MS**

Product List		Detail
ลูกบ็อกซ์ 1/2"	Socket Wrench	4S-10 12 13 14 17 19 21 22 24 26 27 30 32 (6pt.)
ด้ามพรี 1/2"	Ratchet Handle	RH4H
ด้ามบ็อกซ์	Short Spinner Handle	NS4S
ข้อต่อ	Extension Bar	321
ข้ออ่อน	Ball Joint	BJ40
กล่องโลหะ	Metal Case	MCT2

# TORQUE WRENCH (PRESENT TYPE)

## ประเภทปอนด์แบบด้านฟรี

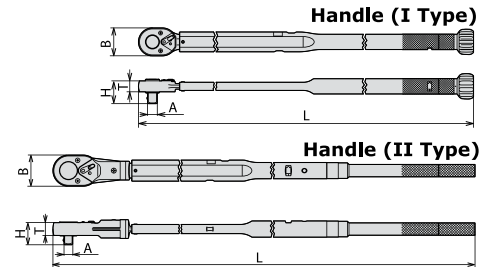

Item No.	Torque Range	Units	A (mm)	H (mm)	L (mm)
T6A420N	60 ~ 420	N.m	19	42.7	950
T6L700N	100 ~ 700	N.m	19	49.5	1314
T8L850N	100 ~ 850	N.m	25.4	58.0	1388
T8L1000N	100 ~ 1,000	N.m	25.4	58.0	1538
T8L1500N	200 ~ 1,500	N.m	25.4	61.0	1844
T8L2100N	700 ~ 2,100	N.m	25.4	61.0	2064



### Digital Reading

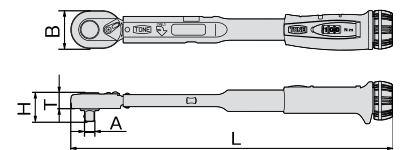

Item No.	Torque Range	Units	A (mm)	B (mm)	H (mm)	T (mm)	L (mm)
T2MN6	1 - 6	N.m	6.4	24.0	18.3	10.4	222
T2MN13	3 - 13	N.m	6.4	24.0	18.3	10.4	253
T3MN20	4 - 20	N.m	9.5	24.0	21.5	10.4	253
T3MN50	10 - 50	N.m	9.5	36.0	26.4	14.0	308
T4MN50	10 - 50	N.m	12.7	36.0	30.4	14.0	308
T3MN100	20 - 100	N.m	9.5	36.0	16.4	14.0	387
T4MN100	20 - 100	N.m	12.7	36.0	30.4	14.0	387
T4MN140	30 - 140	N.m	12.7	36.0	30.4	14.0	450
T4MN200	40 - 200	N.m	12.7	45.2	34.0	17.8	526
T4MN300	40 - 300	N.m	12.7	45.2	34.0	17.8	716
T6MN300	40 - 300	N.m	19.0	45.2	41.5	17.8	716

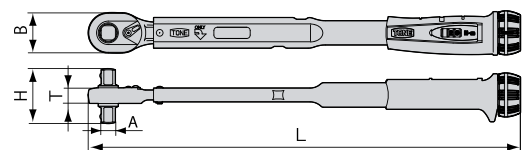

### DIGITAL READING (for both R&L hand threads)

Item No.	Torque Range	Units	A (mm)	B (mm)	H (mm)	T (mm)	L (mm)
T4MN100R	20 ~ 100	N.m	12.7	36.0	49.2	14.0	387
T4MN140R	30 ~ 140	N.m	12.7	36.0	49.2	14.0	450
T4MN200R	40 ~ 200	N.m	12.7	45.2	52.7	20.5	526
T6MN300R	40 ~ 300	N.m	19.0	45.2	65.2	20.5	716

# TORQUE WRENCH (ADJUSTABLE WRENCH TYPE)

## ประแจปอนด์ปากเลื่อน



Digital Reading

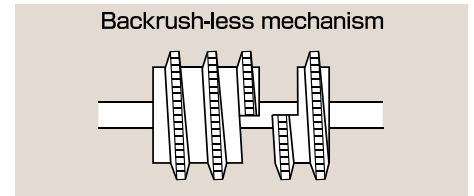
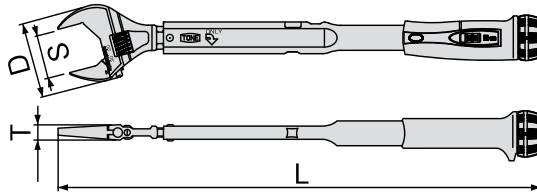

Backrush-less mechanism  
Divided worms catch the rack on lower jaw firmly.  
This mechanism enables not to loosen the wrench.

TORQUE WRENCH

TONE Made in Japan

Item No.	Torque Range	Units	D (mm)	S (mm)	T (mm)	L (mm)
TMWM15	3 ~ 15	N.m	49.3	10 ~ 27	9.9	289
TMWM25	5 ~ 25	N.m	49.3	10 ~ 27	9.9	330
TMWM25W	5 ~ 25	N.m	66.8	17 ~ 38	13.3	346
TMWM50	10 ~ 50	N.m	49.3	10 ~ 27	9.9	330
TMWM50W	10 ~ 50	N.m	66.8	17 ~ 38	13.3	346
TMWM60	15 ~ 60	N.m	49.3	10 ~ 27	9.9	330
TMWM100	20 ~ 100	N.m	66.8	17 ~ 38	13.3	420
TMWM100W	20 ~ 100	N.m	83.3	27 ~ 48	16.0	438
TMWM115	25 ~ 115	N.m	66.8	17 ~ 38	13.3	420
TMWM150	50 ~ 150	N.m	66.8	17 ~ 38	13.3	483
TMWM150W	50 ~ 150	N.m	83.3	27 ~ 48	16.0	500
TMWM200	40 ~ 200	N.m	83.3	27 ~ 48	16.0	570

# TORQUE GRIP SET

## ชุดไขควงทอร์ก



**TGS20**

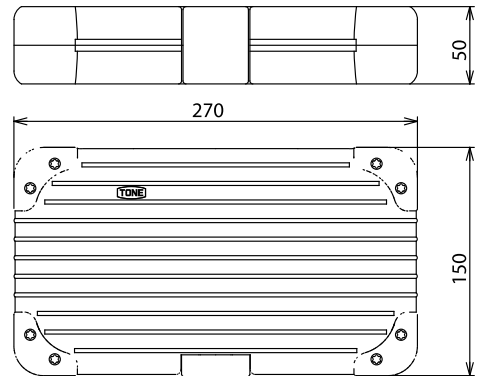

Item No.		Contents
TGS20	TG-	0.6 (0.6 N.m), 0.9 (0.9 N.m), 1.2 (1.2 N.m) 1.4 (1.4 N.m), 2 (2 N.m), 3 (3 N.m), 5 (5 N.m)

# BIT RATCHET SET

## ชุดด้ามฟรีพร้อมดอกไขควง



**BRS20**



Contents			
Bit Ratchet	BR	Hex Bit	BT-H4 BT-H5 BT-H6 BT-H8
Bit holder	RDBH-065	Torx Bit	BT-T15H BT-T20H BT-T25H
Screwdriver Bit	BT-P1 BT-P2 BT-P3 (2each)		BT-T27H BT-T30H BT-T40H
Screwdriver Bit	BT-M5.5 BT-M6 BT-M8	Bit Adapter	BTA2 (1/4" 6.35 MM)



# TORQUE GRIP

## ไขควงทอร์ก



TG3



TG5

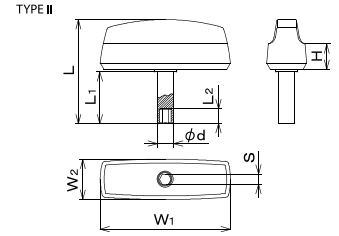
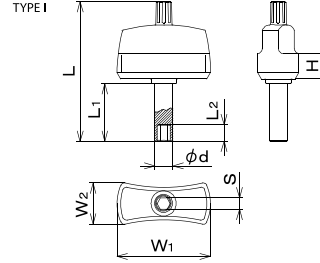

Item No.	Torque (N.m)	ACC	S (mm)	Dimension (mm)							Weight (g)
				W1	W2	H	D	L1	L2	L	
TG0.6	0.6	±15	6.35	52	23	14	10	32	9	77.5	48
TG0.9	0.9	±15	6.35	52	23	14	10	32	9	77.5	48
TG1.2	1.2	±15	6.35	52	23	14	10	32	9	77.5	48
TG1.4	1.4	±15	6.35	52	23	14	10	32	9	77.5	48
TG2	2.0	±10	6.35	52	23	14	10	32	9	77.5	48
TG3	3.0	±10	6.35	52	23	14	10	32	9	77.5	48
TG5	5.0	±10	6.35	81	25	16	10	32	9	64.5	65

# BIT RATCHET

## ไขควงด้ามฟรี



RD



RSD



RTD

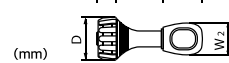
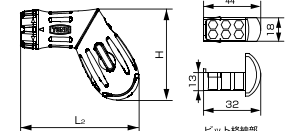
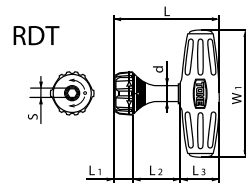
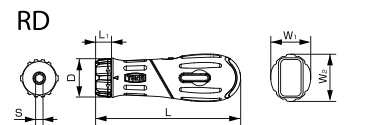
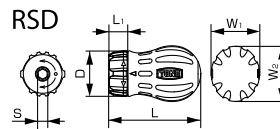

Item No.	S (mm)	D	Dimension (mm)							Weight (g)
			W1	W2	H	L1	L2	L3	L	
RD	6.35	34	36	41	80	14	103	-	128.6	203
RSD	6.35	34	36	41	-	14	103	-	68.3	121
RDT	6.35	34	100	25	-	14	37	31	83	171

# BIT HOLDER

## ด้ามต่อดอกไขควง

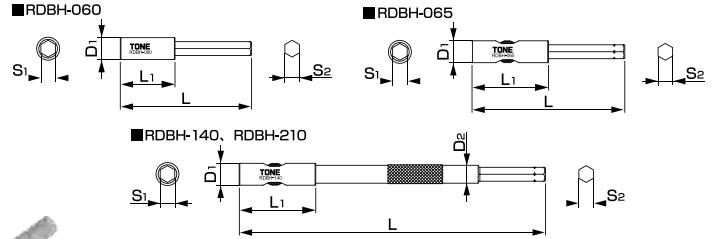

RDBH-210 RDBH-140 RDBH-065 RDBH-060



Item No.	S1 (mm)	S2 (mm)	Dimension (mm)				Weight (g)
			D1	D2	L1	L	
RDBH-060	6.35	6.35	10	-	25	60	21
RDBH-065	6.35	6.35	10	-	35	65	23
RDBH-140	6.35	6.35	10	8.3	35	140	55
RDBH-210	6.35	6.35	10	8.3	35	210	85



# BIT SET

## ชุดดอกลไขควง



BTTH10S

Contents

BT-T6H BT-T7H BT-T8H BT-T9H BT-T10H  
BT-T15H BT-T20H (T6H T7H T8H 2each)



BTTH12S

Contents

BTT-T6G BT-T7H BT-T8H BT-T9H BT-T10H BT-T15H  
BT-T20H BT-T25H BT-T27H BT-T30H BT-T40H (T6H 2each)



BTIP10S

Contents

BT-6IP BT-7IP BT-9IP BT-10IP  
BT-15IP BT-20IP (6IP 8IP 2each)



BTIP12S

Contents

BT-6IP BT-7IP BT-8IP BT-9IP BT-10IP  
BT-15IP BT-20IP BT-25IP BT-27IP BT-30IP BT-40IP (6IP 2each)

# SCREWDRIVER

## ไขควง



**KD6**

ชุดไขควงด้ามพลาสติก 6 ชิ้น  
(แฉกทะลุหัวตอก)



Screwdriver Set (Through Type)	
Item No.	Contents
KD6	- KMD-075, KMD-100, KMD-150 + KPD-001, KPD-002, KPD-003



**PGD8**

ชุดไขควงด้ามยาง 8 ชิ้น  
(แฉกทะลุหัวตอก)



Power Grip Screwdriver Set (Through Type)	
Item No.	Contents
PGD8	- PGMD-075, PGMD-100, PGMD-150, PGSD-M2 + PGPD-001, PGPD-002, PGPD-003, PGSD-P2



Made in Japan



SCREWDRIVER

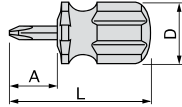

**SD-M/SD-P**

ไขควงด้ามสั้น



Stubby Screwdriver				
Item No.	Size (mm)	D (mm)	A (mm)	L (mm)
SD-M	-0.8 x 7.2	31	23	70
SD-P	+NO.2	31	23	70

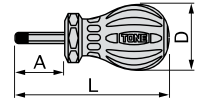

**PGSD-M2/PGSD-P**

ไขควงด้ามยางสั้น



Power Stubby Screwdriver				
Item No.	Size (mm)	D (mm)	A (mm)	L (mm)
PGSD-M2	- 0.8 x 6.0	34	25	82
PGSD-P2	+NO.2	34	25	82



**KMD-075**

**KMD-100**

**KMD-150**

**KPD-001**

**KPD-002**

**KPD-003**

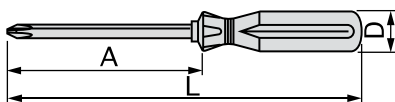

ไขควงด้ามพลาสติก (ตอก)

Screwdriver (Through Type)				
Item No.	Size (mm)	D (mm)	A (mm)	L (mm)
KMD-075	-0.6 x 4.9	22	75	150
KMD-100	-0.8 x 6.0	24	100	195
KMD-150	-1.0 x 9.0	29.5	150	260
KPD-001	+No.1	22	75	150
KPD-002	+No.2	24	100	195
KPD-003	+No.3	29.5	150	260



**PGMD-075**

**PGMD-100**

**PGMD-150**

**PGPD-001**

**PGPD-002**

**PGPD-003**

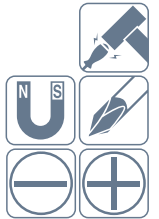
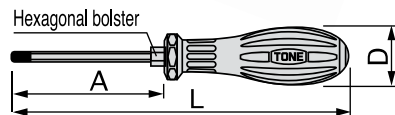

ไขควงด้ามยาง (ตอก)

Power Screwdriver (Through Type)				
Item No.	Size (mm)	D (mm)	A (mm)	L (mm)
PGMD-075	-0.8 x 5.5	31	75	167
PGMD-100	-1.0 x 6.0	34	100	198
PGMD-150	-1.2 x 8.0	36	150	258
PGPD-001	+No.1	31	75	167
PGPD-002	+No.2	34	100	198
PGPD-003	+No.3	36	150	258

# OTHER HAND TOOLS

## ค้อน

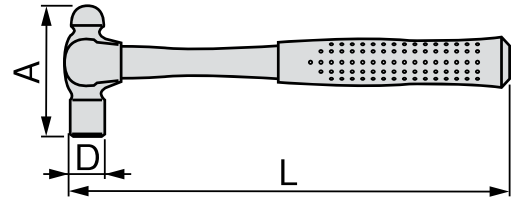

Ball Peen Hammer /Nail Hammer (ค้อน)				
Item No.	Standard	A (mm)	D (mm)	L (mm)
BH-05	0.5 lbs.	82	23	290
BH-10	1.0 lbs.	104	30	325
BH-15	1.5 lbs.	118	35	375
BH-20	2.0 lbs.	130	38	375
BH-05B	0.5 lbs.	103	22	300

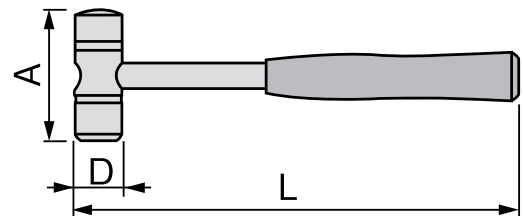

Combination Hammer (ค้อนผสม)				
Item No.	Standard	A (mm)	D (mm)	L (mm)
BHC-05	0.5 lbs.	72	26	290
BHC-10	1.0 lbs.	87	32	300
BHC-15	1.5 lbs.	100	38	330

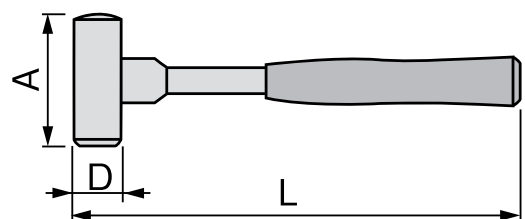

Urethane Shockless Hammer				
Item No.	Standard	A (mm)	D (mm)	L (mm)
UH-10	1.0 lbs.	100	49	330